

---

# Nový RAPIER

---

**NOVÝ RAPIER od 08/2012**







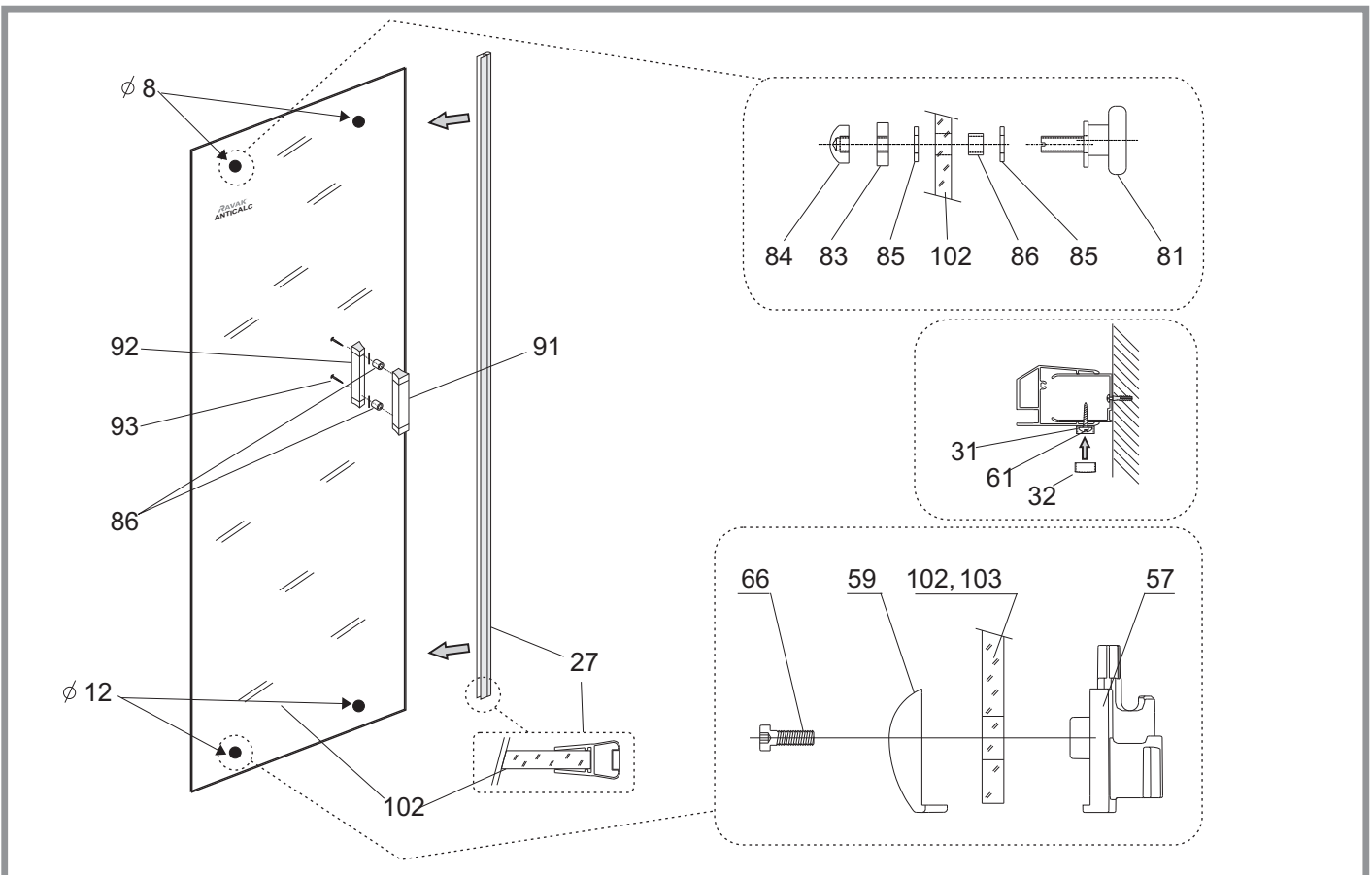
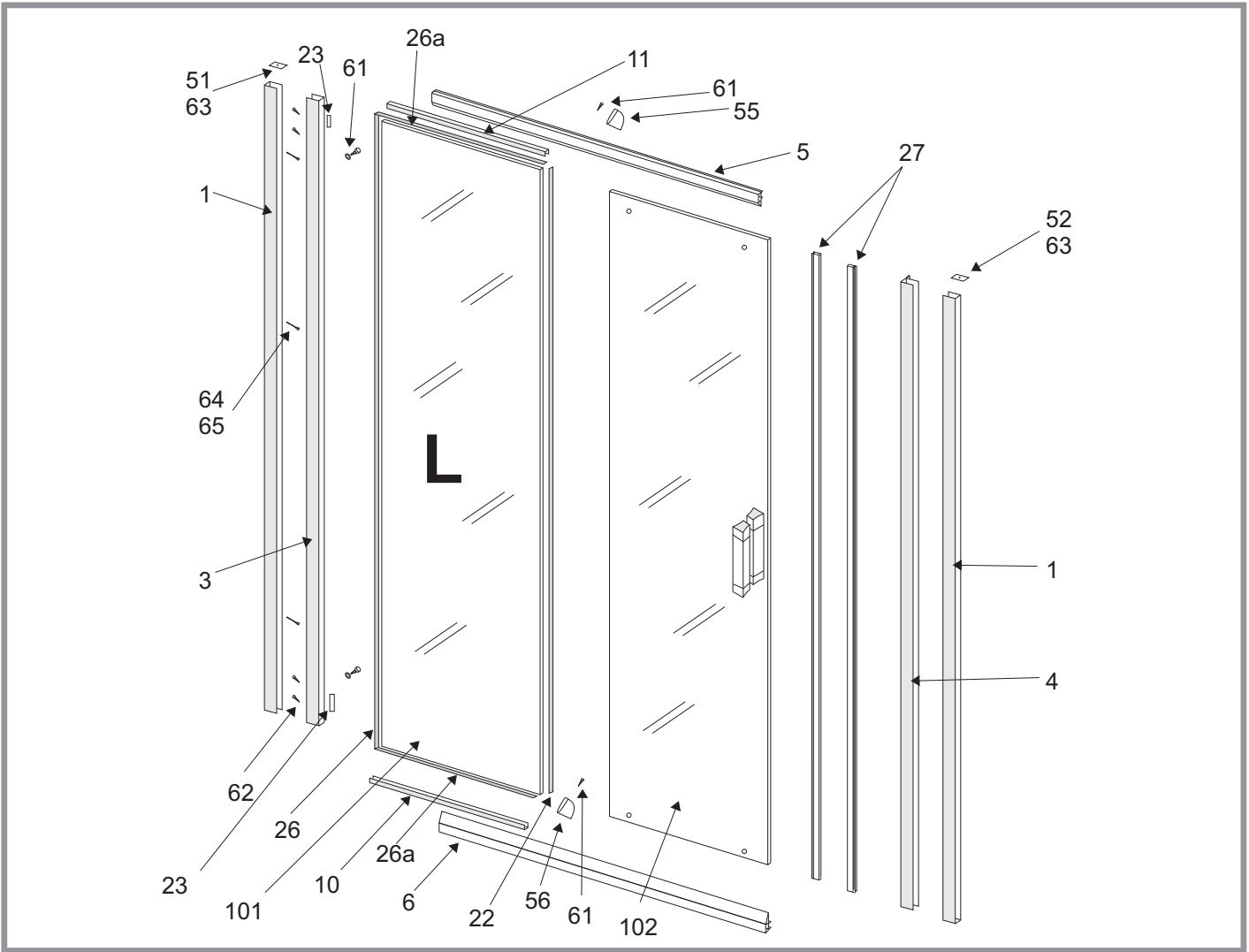







**Katalog dílů**

**RAVAK<sup>®</sup>**





















# RAPIER NRDP2 - 100,110,120 L/R - SATIN

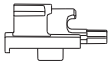







**RAPIER NRDP2 - 100,110,120 L/R - SATIN**

Číslo dílu	Název dílu	Rozměr mm	Pro rozměr výrobku	SIČ	Typový díl pro všechny rozměry SIČ	
1	„U“ profil přímý	dl. 1900			XVRA0501X1900	
3	Svislý profil PD	dl. 1900			XVRA0301X1900	
4	Svislý profil D2	dl. 1900			XVRA0402X1900	
5	Vodící profil - HORNÍ	dl. 858	<b>NRDP2-100L</b>	XVRA0110X0858		
		dl. 858	<b>NRDP2-100R</b>	XVRA0109X0858		
		dl. 958	<b>NRDP2-110L</b>	XVRA0112X0958		
		dl. 958	<b>NRDP2-110R</b>	XVRA0111X0958		
		dl. 1058	<b>NRDP2-120L</b>	XVRA0114X1058		
		dl. 1058	<b>NRDP2-120R</b>	XVRA0113X1058		
6	Vodící profil - DOLNÍ	dl. 858	<b>NRDP2-100L</b>	XVRA1209X0858		
		dl. 858	<b>NRDP2-100R</b>	XVRA1210X0858		
		dl. 958	<b>NRDP2-110L</b>	XVRA1211X0958		
		dl. 958	<b>NRDP2-110R</b>	XVRA1212X0958		
		dl. 1058	<b>NRDP2-120L</b>	XVRA1213X1058		
		dl. 1058	<b>NRDP2-120R</b>	XVRA1214X1058		
10	Lem skla	dl. 403	<b>NRDP2-100</b>	XVRA0901X0403		
		dl. 453	<b>NRDP2-110</b>	XVRA0903X0453		
		dl. 503	<b>NRDP2-120</b>	XVRA0905X0503		
11	Lem skla	dl. 403	<b>NRDP2-100</b>	XVRA0902X0403		
		dl. 453	<b>NRDP2-110</b>	XVRA0904X0453		
		dl. 503	<b>NRDP2-120</b>	XVRA0906X0503		
22	Svislý těsnící profil 89	dl. 1800			X88900000000	
23	Profil měkk. dorazu 91	dl. 133			X89100000000	
26	Zasklívací profil 90	dl. 1815			X89000000000	
26a	Zasklívací profil 111	dl. 1200			X8B100000000	
27	Magnetický profil přímý	dl. 1882	 pár		X6C124600170	
28	Magnetický profil přímý	dl. 1900			X6C124600160	

**RAPIER NRDP2 - 100,110,120 L/R - SATIN**

Číslo dílu	Název dílu	Rozměr mm	Pro rozměr výrobku	SIČ	Typový díl pro všechny rozměry SIČ	
31	Podložka krytky 106	Ø 11			X8A600000000	
32	Krytka šedá	Ø 11			X8A500000000	
33	Záslepka	Ø10			X80001100100	
51	Krytka ustav. profilu 78A	PÁR			X878A0000000	
52	Krytka ustav.profilu 78B				X878B0000000	
55	Koncovka 84A	PÁR			X884A0000000	
56	Koncovka 84B				X884B0000000	
61	Šroub samoř.DIN 7981	Ø 3,5 x 13			X97981035130	
62	Šroub samoř.DIN 7981	Ø 3,5 x 25			X97981035250	
63	Šroub samoř.DIN7982	Ø 3,5 x 13			X97982035130	
64	Vrut do hmoždinky	Ø 4 x 40			X94000040400	
65	Hmoždinka	Ø 8			X20600080000	
<b>Kluzák pružinový pro Rapier N KOMPLET</b>				Počet kusů	<b>SIČ: D00000U006</b>	
57	Kluzák vnější			1	X8C800000000	
	Kluzák vnitřní			1	X8C900000000	
	Pružina nerezová			1	X3C0RAD110010	
	Kolík válcový			1	X92338020040	
59	Podložka			1	X8D000000000	
66	Šroub	M4x12		1	X90984040120	
<b>Kolečko pevné pro Rapier N KOMPLET</b>				Počet kusů	<b>SIČ: D000000001</b>	
81	Ložiskový pojezd	Jednoduchý		1	X3C0240304016	
83	Matice	M 6 x 4		1	X3C0RAD02001A	
84	Krytka	M 6 x 7		1	X3C0RAD02002A	
85	Podložka plastová	Ø 12,8x1,5		2	X88700000000	
86	Průchodka plastová	Ø 7,7x5,5		1	X88800000000	

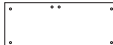

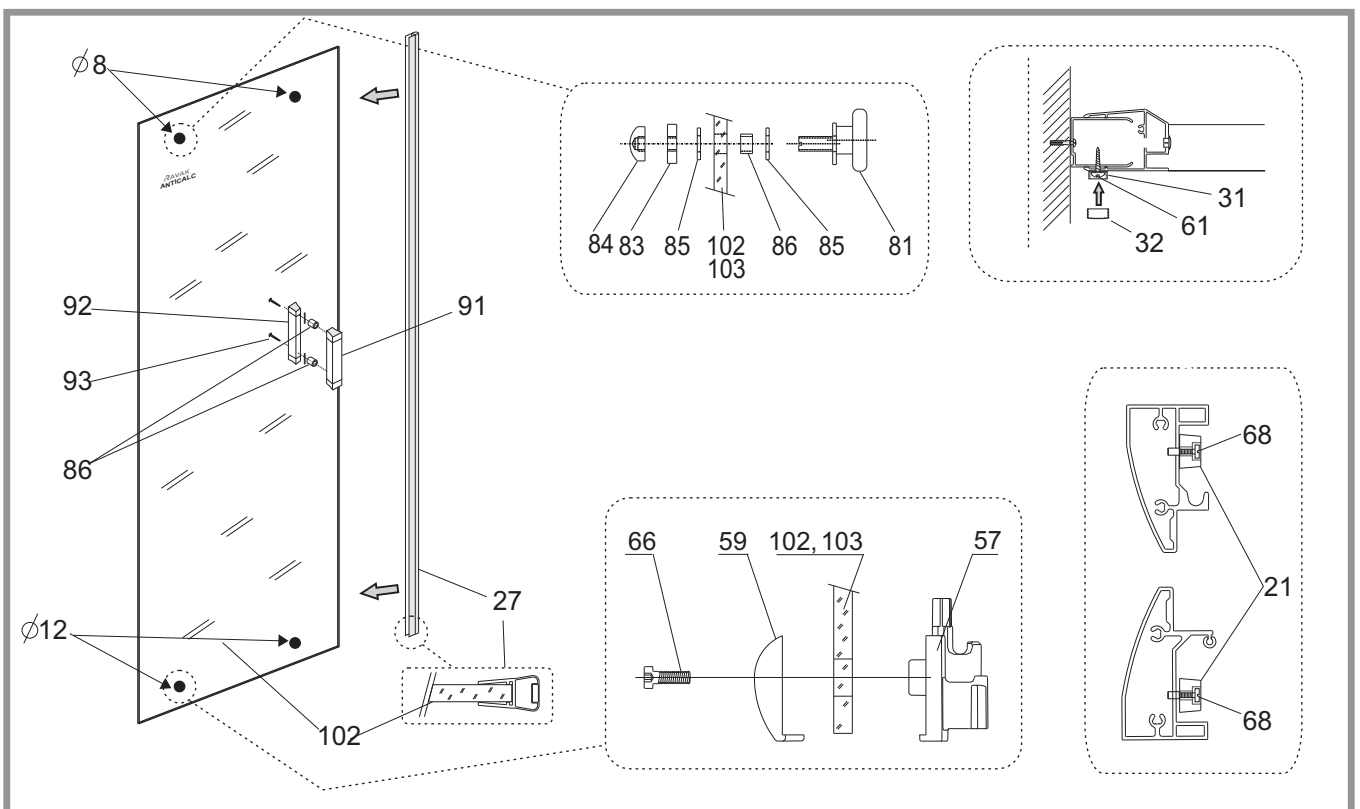
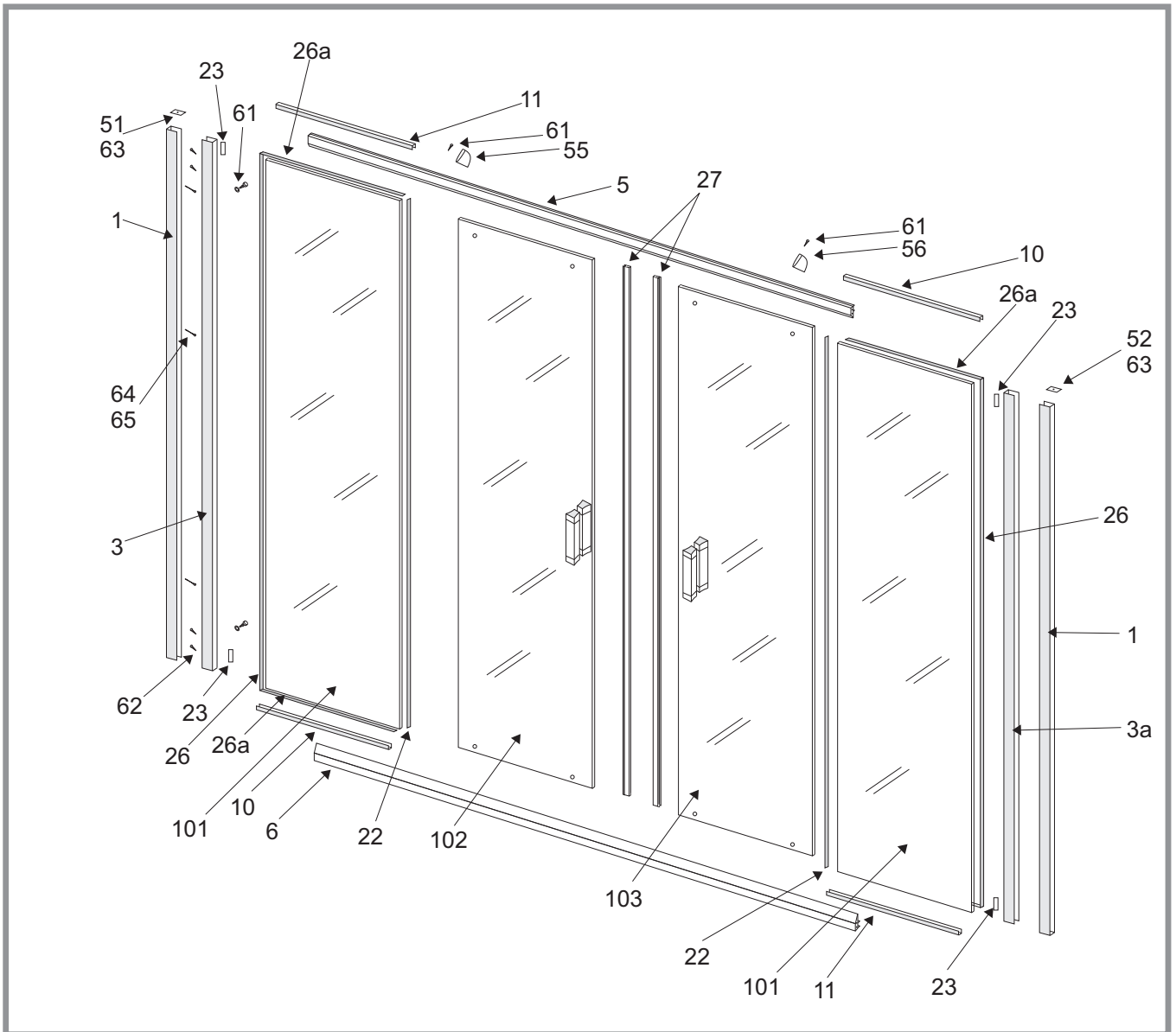

**RAPIER NRDP2 - 100,110,120 L/R - SATIN**

Číslo dílu	Název dílu	Rozměr mm	Pro rozměr výrobku	SIČ	Typový díl pro všechny rozměry SIČ	
<b>Madlo pro Rapier N KOMPLET</b>				Počet kusů	<b>SIČ: D00000U005</b>	
91	Madlo vnější	dl. 165		1	XVRA1102X0145	
92	Madlo vnitřní	dl. 165		1	XVRA1101X0145	
93	Šroub	M 4 x 40		2	X90964040400	
86	Průchodka plastová	∅ 7,7x5,5		2	X88800000000	
	Krytka madla chrom			4	X8D300000000	
	Podložka madla trans.			2	X3C0RAD040010	
	Nýt M4	M 4		2	X92030040000	
101	Sklo PS tl. 6 mm	1815x397	<b>NRDP2-100L/R</b>	X4Z160I15397		
		1815x447	<b>NRDP2-110L/R</b>	X4Z160I15447		
		1815x497	<b>NRDP2-120L/R</b>	X4Z160I15497		
102	Sklo dveří L tl. 6 mm	1880x478	<b>NRDP2-100L</b>	X4Z160I80478O		
		1880x528	<b>NRDP2-110L</b>	X4Z160I80528O		
		1880x578	<b>NRDP2-120L</b>	X4Z160I80578O		
103	Sklo dveří R tl. 6 mm	1880x478	<b>NRDP2-100R</b>	X4Z160I80478P		
		1880x528	<b>NRDP2-110R</b>	X4Z160I80528P		
		1880x578	<b>NRDP2-120R</b>	X4Z160I80578P		















# RAPIER NRDP4 - 120,130,140,150,160,170,180,190,200 - SATIN



**RAPIER NRDP4 - 120,130,140,150,160,170,180,190,200 - SATIN**

Číslo dílu	Název dílu	Rozměr mm	Pro rozměr výrobku	SIČ	Typový díl pro všechny rozměry SIČ	
1	„U“ profil přímý	dl. 1900			XVRA0501X1900	
3	Svislý profil PD	dl. 1900			XVRA0302X1900	
3a	Svislý profil PD	dl. 1900			XVRA0301X1900	
5	Vodící profil HORNÍ	dl. 1058	<b>NRDP4-120</b>	XVRA0137X1058		
		dl. 1158	<b>NRDP4-130</b>	XVRA0138X1158		
		dl. 1258	<b>NRDP4-140</b>	XVRA0139X1258		
		dl. 1358	<b>NRDP4-150</b>	XVRA0127X1358		
		dl. 1458	<b>NRDP4-160</b>	XVRA0128X1458		
		dl. 1558	<b>NRDP4-170</b>	XVRA0129X1558		
		dl.1658	<b>NRDP4-180</b>	XVRA0130X1658		
		dl. 1758	<b>NRDP4-190</b>	XVRA0140X1758		
		dl. 1858	<b>NRDP4-200</b>	XVRA0141X1858		
6	Vodící profil DOLNÍ	dl. 1058	<b>NRDP4-120</b>	XVRA1237X1058		
		dl. 1158	<b>NRDP4-130</b>	XVRA1238X1158		
		dl. 1258	<b>NRDP4-140</b>	XVRA1239X1258		
		dl. 1358	<b>NRDP4-150</b>	XVRA1227X1358		
		dl. 1458	<b>NRDP4-160</b>	XVRA1228X1458		
		dl. 1558	<b>NRDP4-170</b>	XVRA1229X1558		
		dl.1658	<b>NRDP4-180</b>	XVRA1230X1658		
		dl. 1758	<b>NRDP4-190</b>	XVRA1240X1758		
		dl. 1858	<b>NRDP4-200</b>	XVRA1241X1858		
10	Lem skla	dl. 242	<b>NRDP4-120</b>	XVRA0931X0242		
		dl. 267	<b>NRDP4-130</b>	XVRA0933X0267		
		dl. 292	<b>NRDP4-140</b>	XVRA0935X0292		
		dl. 317	<b>NRDP4-150</b>	XVRA0911X0317		
		dl.342	<b>NRDP4-160</b>	XVRA0913X0342		

**RAPIER NRDP4 - 120,130,140,150,160,170,180,190,200 - SATIN**

		dl. 367	<b>NRDP4-170</b>	XVRA0915X0367		
		dl. 392	<b>NRDP4-180</b>	XVRA0917X0392		
		dl. 417	<b>NRDP4-190</b>	XVRA0937X0417		
		dl. 442	<b>NRDP4-200</b>	XVRA0939X0442		
11	Lem skla	dl. 242	<b>NRDP4- 120</b>	XVRA0932X0242		
		dl. 267	<b>NRDP4-130</b>	XVRA0934X0267		
		dl.292	<b>NRDP4-140</b>	XVRA0936X0292		
		dl.317	<b>NRDP4-150</b>	XVRA0912X0317		
		dl.342	<b>NRDP4-160</b>	XVRA0914X0342		
		dl.367	<b>NRDP4-170</b>	XVRA0916X0367		
		dl.392	<b>NRPD4-180</b>	XVRA0918X0392		
		dl.417	<b>NRPD4-190</b>	XVRA0938X0417		
		dl.442	<b>NRDP4-200</b>	XVRA0940X0442		
21	Měkký doraz	ø 16			X88500000000	
22	Svislý těsnící profil 89	dl. 1800			X88900000000	
23	Profil měkk. dorazu 91	dl. 133			X89100000000	
26	Zasklívací profil 90	dl. 1815			X89000000000	
26a	Zasklívací profil 111	dl. 1200			X8B100000000	
27	Magnetický profil přímý	dl. 1882			X6C124600170	
31	Podložka krytky 106	ø 11			X8A600000000	
32	Krytka šedá	ø 11			X8A500000000	
33	Záslepka	ø 10			X80001100100	
51	Krytka ustav.profilu 78A	PÁR			X878A0000000	
52	Krytka ustav.profilu 78B				X878B0000000	
55	Koncovka 84A	PÁR			X884A0000000	
56	Koncovka 84B				X884B0000000	
61	Šroub samoř.DIN 7981	ø 3,5x13			X97981035130	

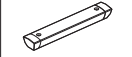

**RAPIER NRDP4 - 120,130,140,150,160,170,180,190,200 - SATIN**

62	Šroub samoř.DIN 7981	∅ 3,5x25			X97981035250	
63	Šroub samoř.DIN 7982	∅ 5x13			X97982035130	
64	Vrutý do hmoždinky	∅ 4x40			X94000040400	
65	Hmoždinka	∅ 8			X20600080000	
68	Šroub DIN 7985	M 4x16			X90085040160	
<b>Kluzák pružinový pro Rapier N KOMPLET</b>				Počet kusů	<b>SIČ: D00000U006</b>	
57	Kluzák vnější			1	X8C800000000	
	Kluzák vnitřní			1	X8C900000000	
	Pružina nerezová			1	X3C0RAD110010	
	Kolík válcový			1	X92338020040	
59	Podložka			1	X8D000000000	
66	Šroub	M4x12		1	X90984040120	
<b>Kolečko pevné pro Rapier N KOMPLET</b>				Počet kusů	<b>SIČ: D000000001</b>	
81	Ložiskový pojezd	Jednoduchý		1	X3C0240304016	
83	Matice	M 6 x 4		1	X3C0RAD02001A	
84	Krytka	M 6 x 7		1	X3C0RAD02002A	
85	Podložka plastová	∅ 12,8x1,5		2	X88700000000	
86	Průchodka plastová	∅ 7,7x5,5		1	X88800000000	
<b>Madlo pro Rapier N KOMPLET</b>				Počet kusů	<b>SIČ: D00000U005</b>	
91	Madlo vnější	dl. 165		1	XVRA1102X0145	
92	Madlo vnitřní	dl. 165		1	XVRA1101X0145	
93	Šroub	M 4 x 40		2	X90964040400	
86	Průchodka plastová	∅ 7,7x5,5		2	X88800000000	
	Krytka madla chrom			4	X8D300000000	
	Podložka madla trans			2	X3C0RAD040010	
	Nýt M4	M 4		2	X92030040000	







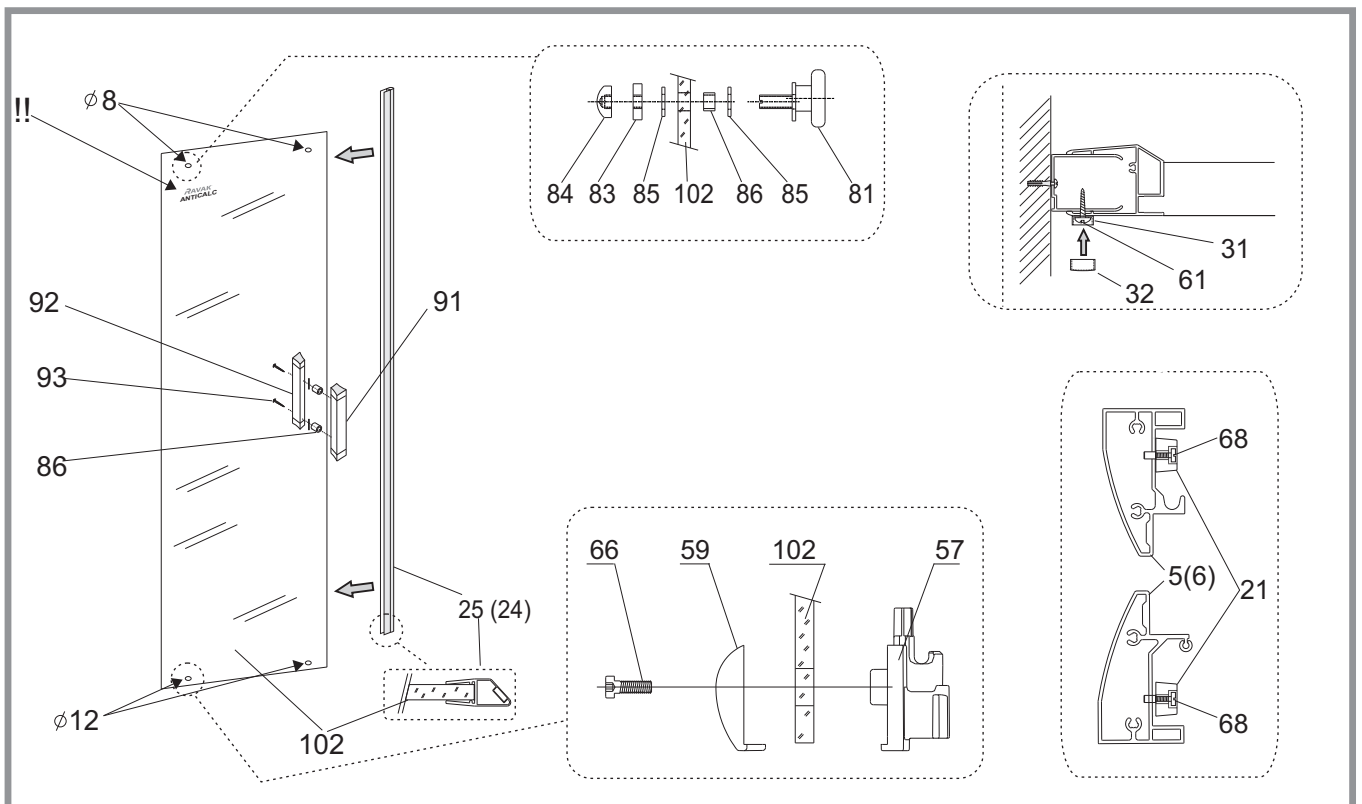
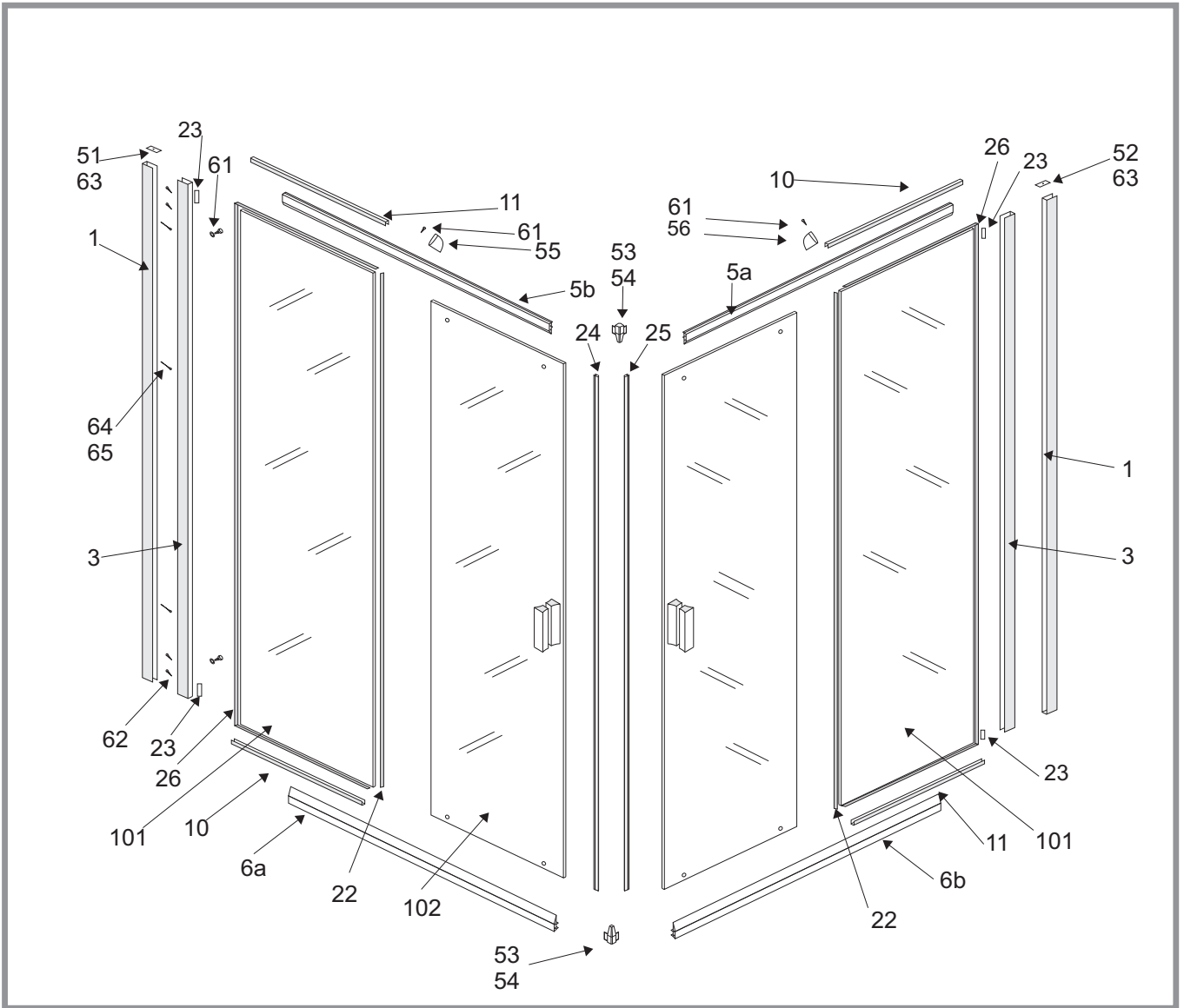



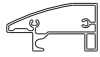

**RAPIER NRDP4 - 120,130,140,150,160,170,180,190,200 - SATIN**

101	Sklo PS tl. 6 mm	1815x236	<b>NRDP4-120</b>	X4Z160I15236		
		1815x261	<b>NRDP4-130</b>	X4Z160I15261		
		1815x286	<b>NRDP4-140</b>	X4Z160I15286		
		1815x311	<b>NRDP4-150</b>	X4Z160I15311		
		1815x336	<b>NRDP4-160</b>	X4Z160I15336		
		1815x361	<b>NRDP4-170</b>	X4Z160I15361		
		1815x386	<b>NRDP4-180</b>	X4Z160I15386		
		1815x411	<b>NRDP4-190</b>	X4Z160I15411		
		1815x436	<b>NRDP4-200</b>	X4Z160I15436		
102	Sklo dveří LEVÉ	1880x317	<b>NRDP4-120</b>	X4Z160I80317O		
		1880x342	<b>NRDP4-130</b>	X4Z160I80342O		
		1880x367	<b>NRDP4-140</b>	X4Z160I80367O		
		1880x392	<b>NRDP4-150</b>	X4Z160I80392O		
		1880x417	<b>NRDP4-160</b>	X4Z160I80417O		
		1880x442	<b>NRDP4-170</b>	X4Z160I80442O		
		1880x467	<b>NRDP4-180</b>	X4Z160I80467O		
		1880x492	<b>NRDP4-190</b>	X4Z160I80492O		
		1880x517	<b>NRDP4-200</b>	X4Z160I80517O		
103	Sklo dveří PRAVÉ	1880x317	<b>NRDP4-120</b>	X4Z160I80317P		
		1880x342	<b>NRDP4-130</b>	X4Z160I80342P		
		1880x367	<b>NRDP4-140</b>	X4Z160I80367P		
		1880x392	<b>NRDP4-150</b>	X4Z160I80392P		
		1880x417	<b>NRDP4-160</b>	X4Z160I80417P		
		1880x442	<b>NRDP4-170</b>	X4Z160I80442P		
		1880x467	<b>NRDP4-180</b>	X4Z160I80467P		
		1880x492	<b>NRDP4-190</b>	X4Z160I80492P		
		1880x517	<b>NRDP4-200</b>	X4Z160I80517P		





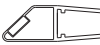













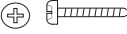

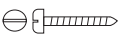
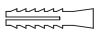
# RAPIER NRKRV2 - 80,90,100 - SATIN

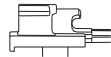





**RAPIER NRKRV2 - 80,90,100 - SATIN**

Číslo dílu	Název dílu	Rozměr mm	Pro rozměr výrobku	SIČ	Typový díl pro všechny rozměry SIČ	
1	„U“ profil přímý	dl. 1900			XVRA0501X1900	
3	Svislý profil PD	dl. 1900			XVRA0301X1900	
5b	Vodící profil HORNÍ - LEVÝ	dl. 670	<b>NRKRV2-80</b>	XVRA0132X0670		
		dl. 770	<b>NRKRV2-90</b>	XVRA0134X0770		
		dl. 870	<b>NRKRV2-100</b>	XVRA0136X0870		
5a	Vodící profil HORNÍ - PRAVÝ	dl. 670	<b>NRKRV2-80</b>	XVRA0131X0670		
		dl. 770	<b>NRKRV2-90</b>	XVRA0133X0770		
		dl. 870	<b>NRKRV2-100</b>	XVRA0135X0870		
6a	Vodící profil DOLNÍ - LEVÝ	dl. 670	<b>NRKRV2-80</b>	XVRA1231X0670		
		dl. 770	<b>NRKRV2-90</b>	XVRA1233X0770		
		dl. 870	<b>NRKRV-100</b>	XVRA1235X0870		
6b	Vodící profil DOLNÍ - PRAVÝ	dl. 670	<b>NRKRV2-80</b>	XVRA1232X0670		
		dl. 770	<b>NRKRV2-90</b>	XVRA1234X0770		
		dl. 870	<b>NRKRV-100</b>	XVRA1236X0870		
10	Lem skla	dl. 303	<b>NRKRV2-80</b>	XVRA0919X0303		
		dl. 353	<b>NRKRV2-90</b>	XVRA0921X0353		
		dl. 403	<b>NRKRV2-100</b>	XVRA0901X0403		
11	Lem skla	dl. 303	<b>NRKRV2-80</b>	XVRA0920X0303		
		dl. 353	<b>NRKRV2-90</b>	XVRA0922X0353		
		dl. 403	<b>NRKRV2-100</b>	XVRA0902X0403		
21	Měkký doraz 85CB	ø 16			X88500000000	
22	Svislý těsnící profil 89	dl. 1800			X88900000000	
23	Profil měkk. dorazu 91	dl. 133			X89100000000	
24	Magnet. profil šikmý L	dl. 1882	 pár		X6C124700170	
25	Magnet. profil šikmý P	dl. 1882			X6C124800170	
26	Zasklívací profil 90	dl. 3630			X89000000000	

**RAPIER NRKRV2 - 80,90,100 - SATIN**

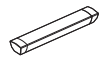
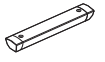



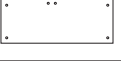
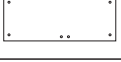















26a	Zasklívací profil 111	dl. 1584			X8B100000000	
31	Podložka krytky 106	Ø11			X8A600000000	
32	Krytky šedá	Ø11			X8A500000000	
51	Krytka ustav.profilu 78A	PÁR			X878A0000000	
52	Krytka ustav.profilu 78B				X878B0000000	
53	Rohový spoj 80 CB				X8800000000A	
54	Víčko rohového spoje				X8810000000A	
55	Koncovka 84 A	PÁR			X884A0000000	
56	Koncovka 84 B				X884B0000000	
61	Šroub samoř DIN 7981	Ø3,5x13			X97981035130	
62	Šroub samoř DIN 7981	Ø3,5x25			X97981035250	
63	Šroub samoř DIN 7982	Ø3,5x13			X97982035130	
64	Vrut do hmoždinky	Ø4x40			X94000040400	
65	Hmoždinka	Ø8			X20600080000	
68	Šroub DIN 7985	M 4x16			X90085040160	
<b>Kluzák pružinový pro Rapier N KOMPLET</b>				Počet kusů	<b>SIČ: D00000U006</b>	
57	Kluzák vnější			1	X8C800000000	
	Kluzák vnitřní			1	X8C900000000	
	Pružina nerezová			1	X3C0RAD110010	
	Kolík válcový			1	X92338020040	
59	Podložka			1	X8D000000000	
66	Šroub	M4x12		1	X90984040120	
<b>Kolečko pevné pro Rapier N KOMPLET</b>				Počet kusů	<b>SIČ: D000000001</b>	
81	Ložiskový pojezd	Jednoduchý		1	X3C0240304016	
83	Matice	M 6 x 4		1	X3C0RAD02001A	
84	Krytka	M 6 x 7		1	X3C0RAD02002A	
85	Podložka plastová	Ø 12,8x1,5		2	X88700000000	
86	Průchodka plastová	Ø 7,7x5,5		1	X88800000000	

**RAPIER NRKRV2 - 80,90,100 - SATIN**

Madlo pro Rapier N KOMPLET				Počet kusů	SIČ: D00000U005	
91	Madlo vnější	dl. 165		1	XVRA1102X0145	
92	Madlo vnitřní	dl. 165		1	XVRA1101X0145	
93	Šroub	M 4 x 40		2	X90964040400	
86	Průchodka plastová	∅ 7,7x5,5		2	X88800000000	
	Krytka madla chrom			4	X8D300000000	
	Podložka madla trans			2	X3C0RAD040010	
	Nýt M4	M 4		2	X92030040000	
101	Sklo PS tl. 6mm	1815x297	<b>NRKRV2-80</b>	X4Z160I15297		
		1815x347	<b>NRKRV2-90</b>	X4Z160I15347		
		1815x397	<b>NRKRV2-100</b>	X4Z160I15397		
102	Sklo dveří tl. 6mm LEVÉ	1880x387	<b>NRKRV2-80</b>	X4Z160I80387O		
		1880x437	<b>NRKRV2-90</b>	X4Z160I80437O		
		1880x487	<b>NRKRV2-100</b>	X4Z160I80487O		
102	Sklo dveří tl. 6mm PRAVÉ	1880x387	<b>NRKRV2-80</b>	X4Z160I80387P		
		1880x437	<b>NRKRV2-90</b>	X4Z160I80437P		
		1880x487	<b>NRKRV2-100</b>	X4Z160I80487P		



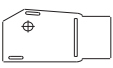
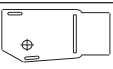







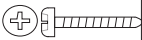

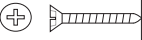
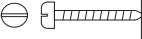
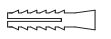
**RAPIER NRKCP4 - 80, 90, 100 - SATIN**

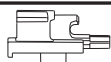
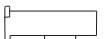

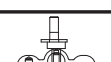

Číslo dílu	Název dílu	Rozměr mm	Pro rozměr výrobku	SIČ	Typový díl pro všechny rozměry SIČ	
1	"U" profil přímý	dl. 1900			XVRA0501X1900	
3	Svislý profil PD	dl. 1900			XVRA0301X1900	
5a	Vodící profil horní	dl. 1190	<b>NRKCP4-80</b>	XVRA0101X1190		
5b	Vodící profil spodní	dl. 1190	<b>NRKCP4-80</b>	XVRA1201X1190		
5a	Vodící profil horní	dl. 1390	<b>NRKCP4-90</b>	XVRA0102X1390		
5b	Vodící profil spodní	dl. 1390	<b>NRKCP4-90</b>	XVRA1202X1390		
5a	Vodící profil horní	dl. 1590	<b>NRKCP4-100</b>	XVRA0103X1590		
5b	Vodící profil spodní	dl. 1590	<b>NRKCP4-100</b>	XVRA1203X1590		
10	Lem skla	dl. 231	<b>NRKCP4-80</b>	XVRA0925X0231		
		dl. 331	<b>NRKCP4-90</b>	XVRA0927X0331		
		dl. 431	<b>NRKCP4-100</b>	XVRA0929X0431		
11	Lem skla	dl. 231	<b>NRKCP4-80</b>	XVRA0926X0231		
		dl. 331	<b>NRKCP4-90</b>	XVRA0928X0331		
		dl.431	<b>NRKCP4-100</b>	XVRA0930X0431		
21	Měkký doraz 85CB	ø 16			X88500000000	
22	Svislý těsnící profil 92	dl. 1882			X89200000000	
22a	Svislý těsnící profil 93	dl.1800			X89300000000	
23	Profil měkk. dorazu 91	dl. 133			X89100000000	
26	Zasklívací profil 90	dl. 3630			X89000000000	
26a	Zasklívací profil 111	dl. 1700			X8B100000000	
27	Magnet. profil přímý	dl. 1882			X6C124600170	
31	Podložka krytky 106	ø 11			X8A600000000	
32	Krytka šedá	ø 11			X8A500000000	
51	Krytka ustav.profilu 78A	PÁR			X878A0000000	
52	Krytka ustav.profilu 78B				X878B0000000	
55	Koncovka 84 A	PÁR			X884A0000000	
56	Koncovka 84 B				X884B0000000	

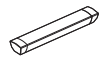
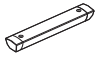

**RAPIER NRKCP4 - 80, 90, 100 - SATIN**

61	Šroub samoř.DIN 7981	∅ 3,5x13			X97981035130	
62	Šroub samoř.DIN 7981	∅ 3,5x25			X97981035250	
63	Šroub samoř.DIN 7982	∅ 3,5x13			X97982035130	
64	Vrut do hmoždinky	∅ 4x40			X94000040400	
65	Hmoždinka	∅ 8			X20600080000	
68	Šroub DIN 7985	M 4x16			X90085040160	
<b>Kluzák pružinový pro Rapier NRKCP4 KOMPLET</b>				Počet kusů	<b>SIČ: D00000U007</b>	
57	Kluzák vnější			1	X8C800000000	
	Kluzák vnitřní			1	X8C900000000	
	Pružina nerezová			1	X3C0RAD110010	
	Kolík válcový			1	X92338020040	
58	Vložka			1	X8D100000000	
59	Podložka			1	X8D000000000	
66	Šroub	M4x20		1	X90984040200	
<b>Kolečko vyklápěcí pro Rapier N KOMPLET</b>				Počet kusů	<b>SIČ: D000000002</b>	
80	Ložiskový pojezd					
81	Kolečko dveří RKCP 4			2	X3CORAD010010	
82	Čep niklovaný			1	X3C0RAD010020	
83	Matice chrom	M 6x4		1	X3C0RAD02001A	
84	Krytka chrom	M 6x7		1	X3C0RAD02002A	
85	Podložka kolečka č.87	∅ 12,8x1,5		2	X88700000000	
86	Průchodka 88	∅ 7,7x5,5		1	X88800000000	
87	Váleček			1	X3C0RAD010030	
88	Nosič koleček			1	X3C0RAD010040	
89	Šroub DIN 7985	M 4x6		1	X90085040060	
90	Šroub DIN 7991	M 5x12		2	X90091050120	



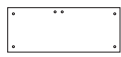
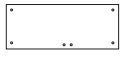



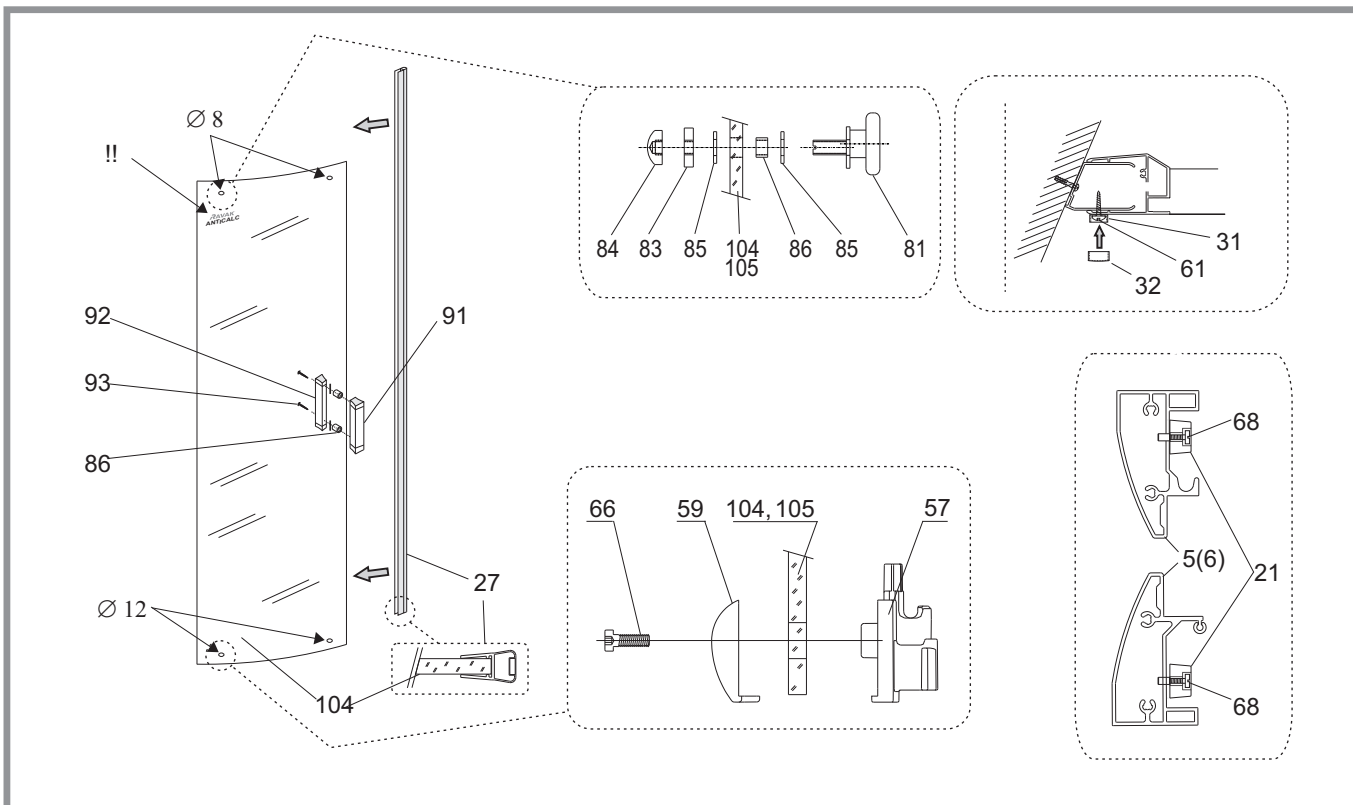
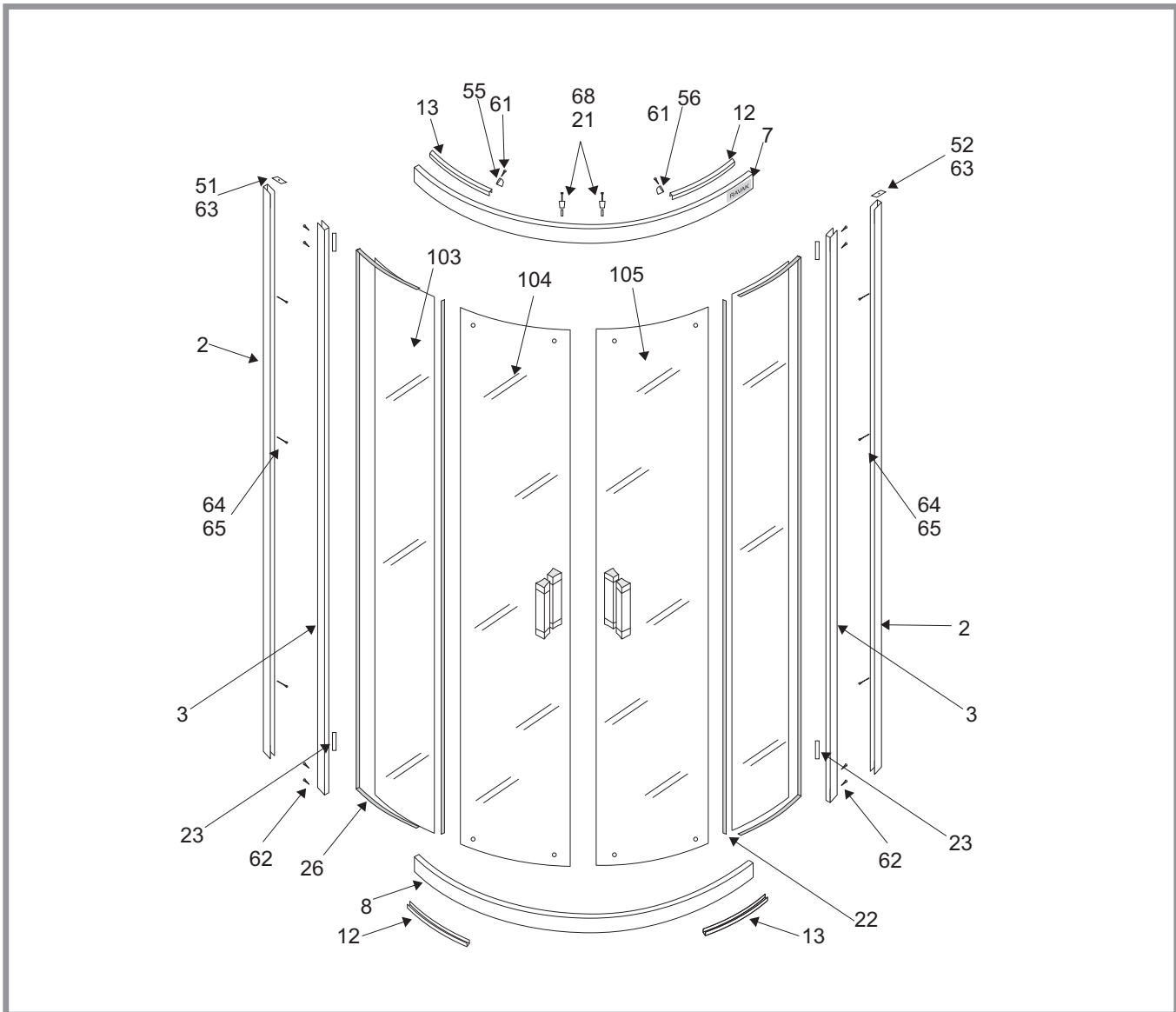





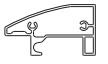







**RAPIER NRKCP4 - 80, 90, 100 - SATIN**

Madlo pro Rapier N KOMPLET				Počet kusů	SIČ: D00000U005	
91	Madlo vnější	dl. 165		1	XVRA1102X0145	
92	Madlo vnitřní	dl. 165		1	XVRA1101X0145	
93	Šroub	M 4 x 40		2	X90964040400	
86	Průchodka plastová	Ø 7,7x5,5		2	X88800000000	
	Krytka madla chrom			4	X8D300000000	
	Podložka madla trans			2	X3C0RAD040010	
	Nýt M4	M 4		2	X92030040000	
101	Sklo PS tl. 6 mm	1815x225	<b>NRKCP4-80</b>	X4Z160I15225		
		1815x325	<b>NRKCP4-90</b>	X4Z160I15325		
		1815x425	<b>NRKCP4-100</b>	X4Z160I15425		
102	Sklo dveří tl. 6 mm LEVÉ	1880x370	<b>NRKCP4-80</b>	X4Y160I80370O		
		1880x370	<b>NRKCP4-90</b>	X4Y160I80370O		
		1880x370	<b>NRKCP4-100</b>	X4Y160I80370O		
102	Sklo dveří tl. 6 mm PRAVÉ	1880x370	<b>NRKCP4-80</b>	X4Y160I80370P		
		1880x370	<b>NRKCP4-90</b>	X4Y160I80370P		
		1880x370	<b>NRKCP4-100</b>	X4Y160I80370P		





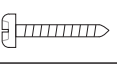
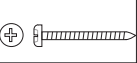
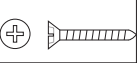

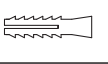
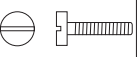



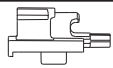



# RAPIER NRKKP4 - 90 - SATIN



**RAPIER NRKKP4 - 90 - SATIN**

Číslo dílu	Název dílu	Rozměr mm	Pro rozměr výrobku	SIČ	Typový díl pro všechny rozměry SIČ	
2	„U“ profil šikmý	dl. 1900		XVRA0801X1900		
3	Svislý profil PD	dl. 1900		XVRA0301X1900		
7	Vodící profil HORNÍ	dl. 1378		XVRA0104X1378		
8	Vodící profil DOLNÍ	dl. 1378		XVRA1204X1378		
12	Lem skla	dl. 303		XVRA0201X0303		
13	Lem skla	dl. 303		XVRA0202X0303		
21	Měkký doraz	ø 13		X8850000000		
22	Svislý těsnící profil 89	dl. 1800		X8890000000		
23	Profil měkk.dorazu 91	dl. 133		X8910000000		
26	Zasklívací profil 90	dl. 3630		X8900000000		
26a	Zasklívací profil 111	dl. 1180		X8B10000000		
27	Magnetický profil přímý	dl. 1882		X6C124600170		
31	Podložka krytky 106	ø 11		X8A60000000		
32	Krytka šedá	ø 11		X8A50000000		
51	Krytka ustav.profilu 78A	PÁR		X878A000000		
52	Krytka ustav.profilu 78B			X878B000000		
55	Koncovka 84A	PÁR		X884A000000		
56	Koncovka 84B			X884B000000		
61	Šroub samoř.DIN 7981	ø 3,5x13		X97981035130		
62	Šroub samoř.DIN 7981	ø 3,5x25		X97981035250		
63	Šroub samoř.DIN 7982	ø 3,5x13		X97982035130		
64	Vrut do hmoždinky	ø 4x40		X94000040400		
65	Hmoždinka	ø 8		X20600080000		
68	Šroub nerez	M 4x16		X90085040160		

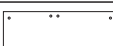





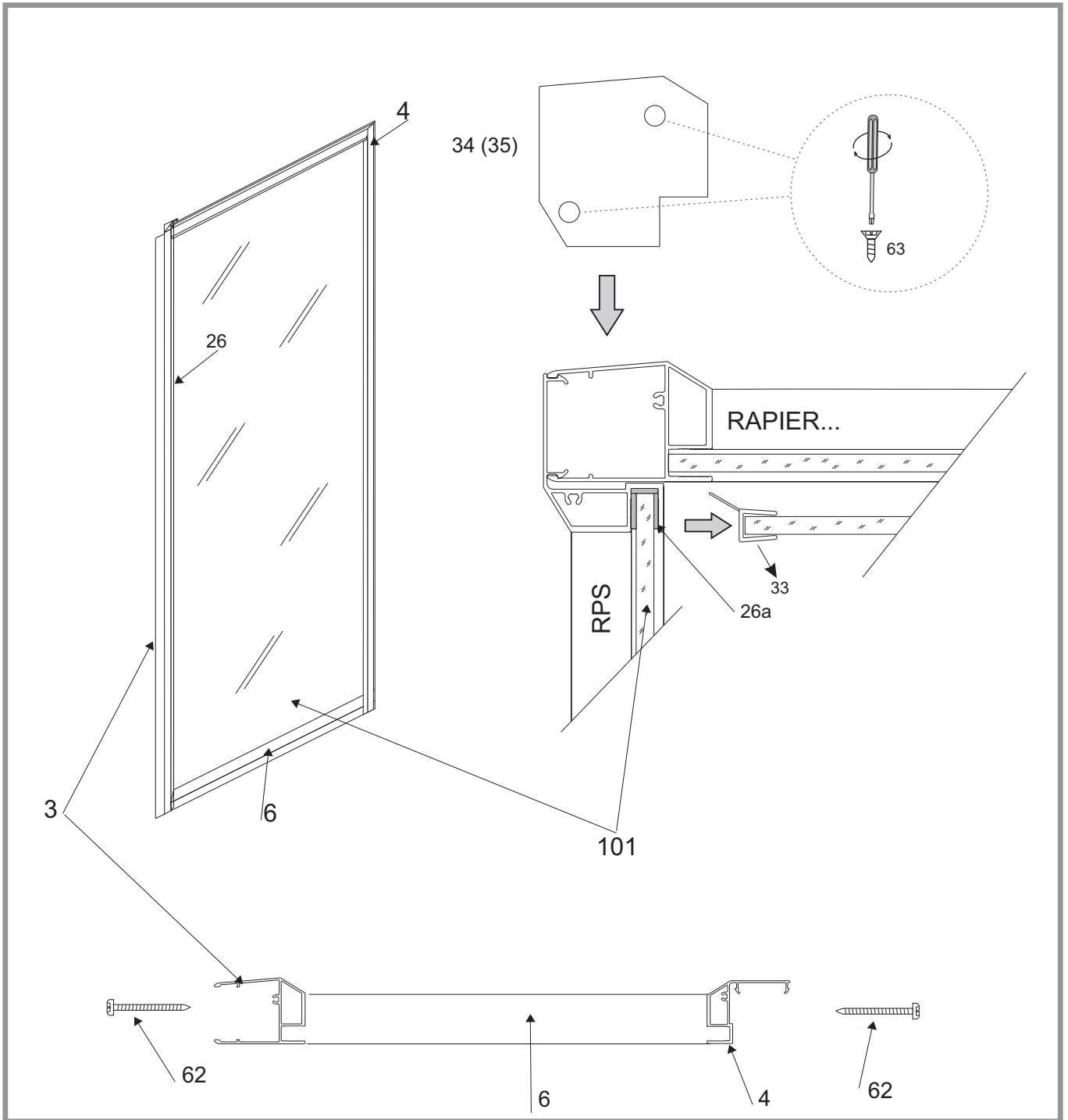



**RAPIER NRKKP4 - 90 - SATIN**

<b>Kluzák pružinový pro Rapier N KOMPLET</b>				Počet kusů	<b>SIČ: D00000U006</b>	
57	Kluzák vnější			1	X8C800000000	
	Kluzák vnitřní			1	X8C900000000	
	Pružina nerezová			1	X3C0RAD110010	
	Kolík válcový			1	X92338020040	
59	Podložka			1	X8D000000000	
66	Šroub	M4x12		1	X90984040120	
<b>Kolečko pevné pro Rapier N KOMPLET</b>				Počet kusů	<b>SIČ: D000000001</b>	
81	Ložiskový pojezd	Jednoduchý		1	X3C0240304016	
83	Matice	M 6 x 4		1	X3C0RAD02001A	
84	Krytka	M 6 x 7		1	X3C0RAD02002A	
85	Podložka plastová	∅ 12,8x1,5		2	X88700000000	
86	Průchodka plastová	∅ 7,7x5,5		1	X88800000000	
<b>Madlo pro Rapier N KOMPLET</b>				Počet kusů	<b>SIČ: D00000U005</b>	
91	Madlo vnější	dl. 165		1	XVRA1102X0145	
92	Madlo vnitřní	dl. 165		1	XVRA1101X0145	
93	Šroub	M 4 x 40		2	X90964040400	
86	Průchodka plastová	∅ 7,7x5,5		2	X88800000000	
	Krytka madla chrom			4	X8D300000000	
	Podložka madla trans			2	X3C0RAD040010	
	Nýt M4	M 4		2	X92030040000	
103	Sklo PS tl. 6mm Z	1815x295			X4Y160I15295	
104	Sklo dveří tl. 6 mm Z LEVÉ	1880x380			X4Y160I80380O	
105	Sklo dveří tl. 6 mm Z PRAVÉ	1880x380			X4Y160I80380P	

# RAPIER RPS - 80,90,100 - SATIN



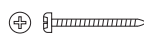

**RAPIER RPS - 80,90,100 - SATIN**

Číslo dílu	Název dílu	Rozměr mm	Pro rozměr výrobku	SIČ	Typový díl pro všechny rozměry SIČ	
3	Svislý profil PD	dl. 1900			XVRA0301X1900	
4	Svislý profil PS	dl. 1900			XVRA0601X1900	
6	Vodorovný profil PS	dl. 658	<b>RPS-80</b>	XVRA0701X0658		
		dl. 758	<b>RPS-90</b>	XVRA0702X0758		
		dl. 858	<b>RPS-100</b>	XVRA0703X0858		
26	Zasklívací profil PS	dl. 1800			X89000000000	
26a	Zasklívací profil 111	dl. 890			X8B100000000	
33	Těsnící profil 135°	dl.1950			X86300000000	
34	Krytka RPS 79 A	PÁR			X879A0000000	
35	Krytka RPS 79 B				X879B0000000	
62	Šroub samoř.DIN 7981	∅ 3,5x25			X97981035250	
63	Šroub samoř.DIN7982	∅ 3,5x13			X97982035130	
101	Sklo tl. 6 mm	1815x682	<b>RPS-80</b>	X4Z160I15682		
		1815x782	<b>RPS-90</b>	X4Z160I15782		
		1815x882	<b>RPS-100</b>	X4Z160I15882		

RPS je možné použít pro výrobky RAPIER i NOVÝ RAPIER.

## KOMPLETY:

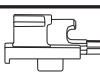
1.)	Madlo pro Rapier N KOMPLET <span style="font-size: small;">satin white</span>			Počet kusů	SIČ: satin - D00000U005 white - D000001045	
91	Madlo vnější	dl. 165		1	XVRA1102X0145	
92	Madlo vnitřní	dl. 165		1	XVRA1101X0145	
93	Šroub	M 4 x 40		2	X90964040400	
86	Průchodka plastová	∅ 7,7x5,5		2	X88800000000	
	Krytka madla chrom			4	X8D300000000	
	Podložka madla trans			2	X3C0RAD040010	
	Nýt M4	M 4		2	X92030040000	

2.)	Kluzák pružinový pro Rapier N KOMPLET <span style="font-size: small;">satin white</span>			Počet kusů	SIČ: satin - D00000U006 white - D000001046	
57	Kluzák vnější			1	X8C800000000	
	Kluzák vnitřní			1	X8C900000000	
	Pružina nerezová			1	X3C0RAD110010	
	Kolík válcový			1	X92338020040	
59	Podložka			1	X8D000000000	
66	Šroub	M4x12		1	X90984040120	

Pro všechny výrobky mimo NRKCP4.

3.)	Kolečko pevné pro Rapier N KOMPLET			Počet kusů	SIČ: D000000001	
81	Ložiskový pojezd	Jednoduchý		1	X3C0240304016	
83	Matice	M 6 x 4		1	X3C0RAD02001A	
84	Krytka	M 6 x 7		1	X3C0RAD02002A	
85	Podložka plastová	∅ 12,8x1,5		2	X88700000000	
86	Průchodka plastová	∅ 7,7x5,5		1	X88800000000	

Pro všechny výrobky mimo NRKCP4.







4.)

<b>Kluzák pružinový pro Rapier NRKCP4 KOMPLET</b> < satin white				Počet kusů	SIČ: satin - D00000U007 white - D000001047	
57	Kluzák vnější			1	X8C800000000	
	Kluzák vnitřní			1	X8C900000000	
	Pružina nerezová			1	X3C0RAD110010	
	Kolík válcový			1	X92338020040	
58	Vložka			1	X8D100000000	
59	Podložka			1	X8D000000000	
66	Šroub	M4x20		1	X90984040200	

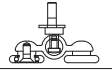
Pouze pro výrobek NRKCP4

5.)

<b>Kolečko vyklápěcí pro Rapier N KOMPLET</b>				Počet kusů	SIČ: D000000002	
80	Ložiskový pojezd					
81	Kolečko dveří RKCP 4			2	X3CORAD010010	
82	Čep niklovaný			1	X3C0RAD010020	
83	Matice chrom	M 6x4		1	X3C0RAD02001A	
84	Krytka chrom	M 6x7		1	X3C0RAD02002A	
85	Podložka kolečka č.87	∅ 12,8x1,5		2	X88700000000	
86	Průchodka 88	∅ 7,7x5,5		1	X88800000000	
87	Váleček			1	X3C0RAD010030	
88	Nosič koleček			1	X3C0RAD010040	
89	Šroub DIN 7985	M 4x6		1	X90085040060	
90	Šroub DIN 7991	M 5x12		2	X90091050120	

Pouze pro výrobek NRKCP4

**V katalogu dílů jsou uvedena SIČ pro výrobky v barevném provedení Satin.  
Pro výrobky v jiné barvě je nutné v SIČ uvést číslo barvy dle kusovníku.**



A series of horizontal dotted lines for writing.

**RAVAK a.s.**, Obecnická 285, 261 01 Příbram I, ČR  
tel.: +420 318 427 111, fax: +420 318 427 278. e-mail: [info@ravak.cz](mailto:info@ravak.cz), [www.ravak.cz](http://www.ravak.cz)

**RAVAK SLOVAKIA spol. s r.o.**, Einsteinová 11, 851 01 Bratislava  
tel.: 02 444 550 01, fax: 02 444 550 02, e-mail: [obchod@ravak.sk](mailto:obchod@ravak.sk), [www.ravak.sk](http://www.ravak.sk)

**RAVAK POLSKA s.a.**, Kałęczyn 2B., ul. Radziejowicka 124, 05-825 Grodzisk Mazowiecki, POLSKA  
tel.: 22 / 755 40 30, fax: 22 / 755 43 90, e-mail: [info@ravak.pl](mailto:info@ravak.pl), [www.ravak.pl](http://www.ravak.pl)

**RAVAK Hungary Kft.**, 1142 Budapest, Erzsébet királyné útja 125, HUNGARY  
tel.: 06 (1) 223 13 15, 06 (1) 223 13 16, fax: 06 (1) 223 13 14, e-mail: [info@ravak.hu](mailto:info@ravak.hu), [www.ravak.hu](http://www.ravak.hu)

**Ravak Gesellschaft für Sanitärprodukte mbH**, Alexanderstrasse 58, D - 45472 Mülheim an der Ruhr  
Tel. (0208) 37789-30 Fax. (0208) 37789-55, [www.ravak.de](http://www.ravak.de), e-mail: [info@ravak.de](mailto:info@ravak.de)

**RAVAK a.s.**, Representative Office in Ukraine, 21 Dniprovska Naberezhna str., 2nd floor, 02081, Kyiv, Ukraine  
tel.: 00380 44 2203232, 00380 44 3605200, fax: 00380 44 2204343, e-mail: [ravak@ravak.kiev.ua](mailto:ravak@ravak.kiev.ua), web: [www.ravak.ua](http://www.ravak.ua)

**OOO RAVAK** ru, ul. Staropetrovskiy pr. 7A, Moskva 125 130,  
tel./fax: 007 495 710 82 23, 007 495 450 12 77, e-mail: [ravak@inbox.ru](mailto:ravak@inbox.ru), [www.ravak.com](http://www.ravak.com)

# RAVAK®

**RAVAK a.s.**, Obecnická 285, 261 01 Příbram I  
tel.: +420 318 427 200, 318 427 111 fax: +420 318 427 269  
e-mail: [info@ravak.cz](mailto:info@ravak.cz), [www.ravak.com](http://www.ravak.com)

Výrobce si vyhrazuje právo změny ceny, technických parametrů, či dalších skutečností bez předchozího upozornění a nenese odpovědnost za tiskové chyby.