

# Collection

COMPLETE OVERVIEW OF RAVAK PRODUCTS 2021/2022





THINK OF YOURSELF, EVERYTHING ELSE HAS BEEN  
TAKEN CARE OF BY US.





## 4 ABOUT US

- 6 References
- 8 Design RAVAK
- 10 Technology
- 12 Materials
- 14 Novelties 2021

## 16 RAVAK CONCEPTS

- 18 Chrome
- 19 10°
- 20 Formy
- 22 Rosa
- 23 Classic
- 24 Avocado
- 25 BeHappy II

## 26 SHOWER ENCLOSURES AND DOORS

- 28 Parameters for choosing shower enclosures and doors
- 32 Custom solution configurator, Atypical products
- 36 Shower Enclosures overview
- 38 Brilliant
- 44 Walk-In
- 50 SmartLine
- 56 Matrix
- 62 10°
- 70 Chrome
- 80 Pivot
- 88 Blix Slim
- 96 Blix
- 110 Supernova

## 128 SEATS

## 134 SHOWER TRAYS, SHOWER CHANNELS AND FLOOR DRAINS

- 136 Shower Trays overview
- 138 Galaxy Pro 10°
- 140 Galaxy Pro Chrome
- 142 Galaxy Pro
- 144 Galaxy Pro Flat
- 146 Deep Seating Shower Tray
- 148 Galaxy
- 150 Kaskada
- 152 Shower Trays Accessories
- 156 Shower Channels and Floor Drains

## 160 BATHTUBS

- 162 Bathtubs overview
- 166 Ypsilon
- 168 Solo
- 170 Freedom O
- 172 Freedom W
- 174 City
- 176 City Slim
- 178 Formy 01
- 180 Formy 01 Slim
- 182 Formy 02
- 184 Formy 02 Slim
- 186 10° (rectangular variant)
- 188 Campanula II
- 190 Chrome (rectangular variant)

- 192 Chrome Slim (rectangular variant)
- 194 Classic
- 196 Vanda II
- 198 NewDay
- 200 Gentiana
- 202 LoveStory II
- 204 10° (asymmetrical variant)
- 206 Chrome (asymmetrical variant)
- 208 Rosa II
- 210 Rosa 95
- 212 Rosa I
- 214 Avocado
- 216 BeHappy II
- 218 Asymmetric
- 220 Technical Drawings - Bathtubs
- 226 Bathtub Accessories

## 230 BATH SCREENS AND DOORS

## 242 WASHBASINS AND BATHROOM FURNITURE

- 244 Washbasins and Furniture overview
- 246 Moon
- 250 Formy (washbasins)
- 252 Solo
- 254 Ceramic Slim and Ceramic
- 258 Uni Slim and Uni
- 260 Uni Slim (B, S, R)
- 262 Countertop L and I
- 264 SUD
- 266 Balance
- 274 Comfort
- 282 Step
- 286 Formy (furniture)
- 290 10°
- 296 Chrome
- 308 Rosa
- 314 Classic
- 322 Clear
- 326 Natural
- 332 BeHappy II
- 336 Avocado
- 338 Veda
- 340 Washbasin Accessories

## 342 SANITARY WARE AND ACCESSORIES

## 352 FAUCETS AND BATHROOM ACCESSORIES

- 354 Puri
- 358 Flat
- 362 10°
- 366 10° Free
- 372 Chrome
- 380 Classic
- 382 Freestanding Bathtub Faucets
- 384 Bathtub Filling Faucets
- 386 Sink / Washbasin Faucets
- 388 Termo
- 390 Termo Dual Shower Systems
- 392 Neo
- 394 Rosa
- 396 Suzan
- 398 Showers and Accessories
- 404 R-box

## 411 DETERGENTS



## YOU CAN TRUST OUR PRODUCTS

**FOR 30 YEARS** RAVAK HAS BEEN GATHERING EXPERIENCE IN BATHROOM IMPROVEMENT. THAT IS WHY WE KNOW WHAT A COMFORTABLE, BEAUTIFUL AND RELIABLE BATHROOM SHOULD LOOK LIKE.

WE WILL HELP YOU CHOOSE THE BEST.



**10 000 000** satisfied customers  
**10 000** retailers  
**in 50** countries



# References

Capricorn Tower, Dubai

---



## GUESTS OF THE MOST LUXURIOUS HOTELS AROUND THE WORLD ENJOY THE BENEFITS OF RAVAK BATHROOM SOLUTIONS

About seventy percent of our total production is exported and we spread good image of the European products to more than fifty countries around the world. You can find our bathroom equipment in the most famous hotels (Hotel President - Ukraine, Hotel Royal Azur - Tunisia, Jumeirah Lake Tower - Dubai, Hotel Orange - Spain, Pheonicia Grand Hotel - Romania, Marriott Hotel - Poland, Hotel Opera - Ukraine, and many others).The RAVAK products can also be found in many public spaces, recreational facilities, businesses, and mainly in homes.





Hotel Konstantinovski  
St. Petersburg, Russia



Skanes Serail  
Monastir, Tunisia



MAG 218,  
Marina Dubai, UAE

# Design RAVAK

SIMPLE, ORIGINAL SOLUTIONS, CLEAR IDEA FOR EACH CONCEPT,  
UTILITY FIRST.

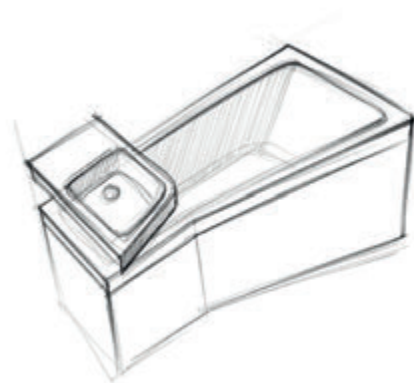

## Kryštof Nosál

Czech product designer and author of many RAVAK bathroom products. Proponent of uncomplicated, clean solutions. Has received Red Dot, iF Design Award, EDIDA, Good Design and many other awards for his RAVAK products.



REFINED THROUGH TIME, RAVAK DESIGN NEVER PALLS.



### **Achim Storz**

Austrian product designer, author of RAVAK baths as well as car interiors for brands such as Porsche, BMW, Audi and more.

# RAVAK Technology

THE LATEST TECHNOLOGIES GIVE THE TOP QUALITY



The quality of a final product is determined not only by the use of high-quality materials, but also by the employed technologies. Ravak is the only company in its field in Central and Eastern Europe to operate its own galvanizing plant and painting shop, guaranteeing perfect control and inspection of the surface finishes of our shower enclosures, doors and bath screens.

The aluminium frames of our shower enclosures receive highly durable satin surface finish. This finish is the result of an electro-chemical process that forms a hard, abrasion-resistant and oxidation-resistant aluminium oxide layer. It provides exceptional scratch resistance and can withstand even aggressive conditions such as high temperature fluctuations, high relative humidity, and exposure to various chemicals commonly used in the bathroom.

In bath production, we use advanced technology of vertical spot heating, which allows us to perfectly stretch acrylic sheets into moulds.

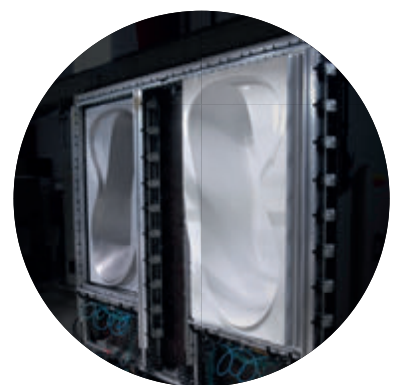

#### **RAVAK Press Shop**

Making an acrylic moulding of a future bath by using the technology of vertical heating.



#### **RAVAK plating plant**

Anodising aluminium profiles - manufacture of the sturdiest shower enclosure, door and bath screen frames.



#### **RAVAK Paint Shop**

Electrostatic powder painting of aluminium shower enclosure, door and bath screen frames.

Surface of glass treated with RAVAK AntiCalc®



GLASS PROTECTION

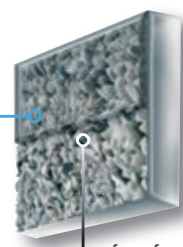

microscopic detail of a glass sample

surface of common glass

#### **RAVAK AntiCalc®**

A revolutionary technology which creates an invisible water repelling protective layer on the glass.



# RAVAK Materials

IN THE AREA OF NEW MATERIAL DEVELOPMENT,  
WE WORK WITH TOP RESEARCH LABORATORIES  
IN EUROPE AND THE USA

We pay great attention to material selection as only carefully processed best ingredients together with innovative design result in top quality product with added value. Cast acrylic (PMMA) is used for the production of bath tubs. It retains its shape in the long term and there is no danger of cracks or distortion. We can therefore provide our baths with extended warranties of 10 years. RAVAK furniture is yet another example of the use of exceptional materials. We have developed our own mechanism to open the furniture, which we use together with the deep-impregnated body using the AMT technology (Anti Moisture Treatment) to endure in harsh environments.



#### **Cast composite material**

It is a mixture of ground dolomite and resin which is used to produce washbasins and shower trays.



**Laminate**

Highly effective reinforcement of acrylic products with polyester resin with glass fibre.



**Thin-walled ceramics**

The washbasins made of special corundum-based blend look very delicate, they have precise and exceptionally thin edges, yet they can withstand everyday use in the bathroom.



**Furniture boards**

Bathroom furniture is manufactured using quality chipboard treated by high-quality moisture impregnation AMT (Anti Moisture Treatment) from leading European manufacturers.

# RAVAK Novelties 2021



Freestanding bathtub Ypsilon



### Step

The first step to a tidy bathroom. Spacious vanity units for countertop washbasins. The natural texture of wood on the veneered furniture brings the calm and beauty of nature into your bathroom.



### Blix Slim black

New colour for the popular shower enclosure. The thin frame gives an air of lightness and slenderness, with the overall elegant impression highlighted by matte black colour. Refined by years of innovation and improvement, the technical solution is built on top-quality materials and time-tested technologies.



### Ypsilon

Extra comfortable bathtub with a light romantic touch. Gently widens up in the shoulder area to provide comfortable placement for the arms and relaxation for the neck and head.





**Supernova**

## 30 YEARS OF EXPERIENCE

Good solutions can serve you in the bathroom for decades. The Supernova shower enclosure is one of the first models created in our plant in Přebor. Thanks to its astounding durability and unique technical solution, the model has sold millions and remains popular among our customers. Its time-tested practical advantages are now coupled with a trendy black colour and new, slender proportions achieved by heightening the shower enclosure. After nearly thirty years, the shower enclosure still fully lives up to its name. Allow Supernova to shine in your bathroom as well.

# RAVAK Concepts

Perfectly matching whole for any  
bathroom or toilet

Whether you like to bathe or shower or you are looking for toilet room equipment, you will surely choose from RAVAK concepts. We offer aesthetically harmonized wholes of bathtubs, shower enclosures, trays, washbasins, furniture, faucets and WC and accessories that logically follow each other, have a clear idea, are developed on the basis of decades of our professional experience and their author's design won't stop entertaining you.

RAVAK concepts are suitable for bathrooms of all sizes, from the smallest to the large ones.

Only RAVAK offers the widest design-matched concept on the market - the universal Chrome concept, which includes more than 200 items for bathroom and toilet.

4

2





- 1 Bathtubs and bath screens - suitable for both bathing and showering
- 2 Shower enclosures and doors - precision manufacture with the use of the best quality components
- 3 Washbasins and Bathroom Furniture - countertop- or vanity unit-mounted, made of cast marble or ceramic
- 4 Toilets and bidets - for perfectly matching your bathroom to the toilet
- 5 Faucets and Bathroom Accessories - made from top-quality materials you can trust in



# Concept Chrome - the widest concept on the Czech market



Design Kryštof Nosál

**Fine-tuned to the most minute detail. Furnishings for the entire bathroom and toilet. Bathtubs now also available with a rim only 18 mm tall.**



Chrome and Chrome Slim rectangular or asymmetrical bathtub see p. 190



Bath screen see p. 234



Shower enclosures in various designs see p. 70



Shower trays or shower channels see p. 140



Seats see p. 128



Washbasins, double washbasin, small washbasin and bathroom furniture see p. 296



WC and bidet see p. 344



Faucets and accessories see p. 372



Bathroom Accessories see p. 378

# Meets you halfway - Concept 10°



reddot design award  
winner 2015



DESIGN  
AWARD  
2016



ELLE  
DECO  
INTERNATIONAL  
DESIGN AWARDS  
TOP  
design  
objects  
2015

Design Kryštof Nosál

**Rotation of individual products by mere 10° stood at the origin of an exceptional concept for bathrooms both large and small. Ergonomics in harmony with original design.**



Asymmetrical bathtub with shelf space or seat, or rectangular bathtub see p. 204



Bath screen see p. 239



Shower Enclosures see p. 62



Shower trays or shower channels see p. 138



Slightly rotated washbasins provide more comfortable access see p. 290



Bathroom Furniture see p. 290



Faucets see p. 362



Bathroom Accessories see p. 370

# Concept Formy - transformation of shapes in two forms



**Puristically clean set of bathtub and washbasin with a refreshing element of asymmetry. Bathtubs now also available with a rim only 18 mm tall.**



Bathtub Formy 01 and Formy 01 Slim  
see p. 178



Washbasin Formy 01  
see p. 250



Waterfall bathtub  
filling faucet  
CR 025.00  
see p. 385



Washbasin faucet  
TD 015.00  
see p. 362



Countertop for washbasin  
see p. 262



Vanity unit Formy  
see p. 287



Tall cabinet  
Formy  
see p. 288



# Transformation of shapes in two forms - **Concept Formy**



**Subtle curving of the longitudinal lines of the washbasin and bathtub gave rise to an original concept. Bathtubs now also available with a rim only 18 mm tall.**



Bathtub Formy 02 and Formy 02 Slim  
see p. 182



Washbasin Formy 02  
see p. 250



Freestanding  
bathtub faucet  
CR 080.00  
see p. 373



Washbasin faucet  
CR 015.00  
see p. 372



Countertop for  
washbasin  
see p. 262



Vanity unit Formy  
see p. 287



Tall cabinet Formy  
see p. 288

# Concept Rosa - A spacious shower enclosure and a large bathtub in one



**Concept suitable for bathrooms both small and large.  
Comprehensive and timeless solution refined to the last detail.**



Surprisingly comfortable bathtubs  
see p. 208



Bath Screens  
see p. 238



Washbasins in different sizes  
see p. 308



Bathroom furniture in three decors  
see p. 308



Tall cabinets with shelves  
see p. 312



Faucets  
see p. 394

# There is beauty in simplicity - **Concept Classic**



Design Kryštof Nosál

**Richly furnished concept for the entire bathroom or toilet.  
Timeless design that never palls.**



Bathtubs with wide, flat bottom  
see p. 194



Bath Screens and  
Doors  
see p. 231



Washbasins, double washbasin and  
small washbasin in different sizes  
see p. 316



Bathroom furniture in four decors  
with high-quality impregnation and fittings  
see p. 318



WC Classic  
see p. 348



Faucets  
see p. 380



# Concept Avocado - The maximum out of minimum



Design Achim Storz

**The concept consists of a small yet comfortable bathtub and a practical washbasin. Perfectly suited for the smallest bathrooms.**



The most space-saving bathtub  
see p. 214



Washbasins with ample shelf space  
suitable for fitting above a bathtub  
see p. 336

# Sophisticated economical solution - **Concept BeHappy II**



**The most space-saving bathroom solution for comfortable bathing and showering.  
For a small bathroom with big possibilities.**



Comfortable bathtub for bathing  
and showering  
see p. 216



Bath screen that can  
be folded  
flat against the wall  
see p. 236



Washbasin designed  
for placement  
above the bathtub  
see p. 333



Vanity unit for straight  
washbasin  
see p. 335







Now 5 year warranty for  
all shower enclosures  
and doors

# Shower Enclosures

A wide variety to choose for  
everybody

Do not be restricted by conventions and create a pleasant place to relax, exactly to your wishes. The shower space can be created in many ways. Choose the optimum solution just for you and combine until you are absolutely satisfied.

We have the right solution for every requirement.

The unifying principle has always been uncompromising quality, water tightness of the shower enclosures and a guarantee of their long life.

# Parameters for choosing shower enclosures and doors

## Colour design of frames



White

Matrix, 10°, Chrome, Pivot, Blix and Supernova



Gloss

Walk-In, SmartLine, Matrix, 10°, Chrome, Pivot, Blix Slim and Blix



Satin

Matrix, 10°, Chrome, Pivot, Blix and Supernova

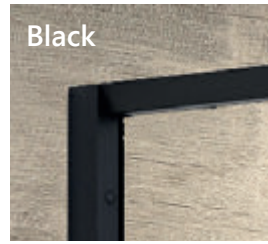

Black

Walk-In, Pivot, Blix Slim and Supernova

## Panels

### Safety glass



Transparent

For all shower enclosure ranges

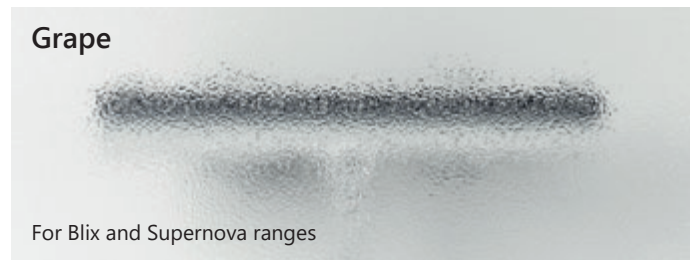

Grape

For Blix and Supernova ranges

### Plastic panel



Pearl

Supernova



Rain

Supernova - for bath screens only

## Atypical panelling – on demand

### Safety glass with print or colouring

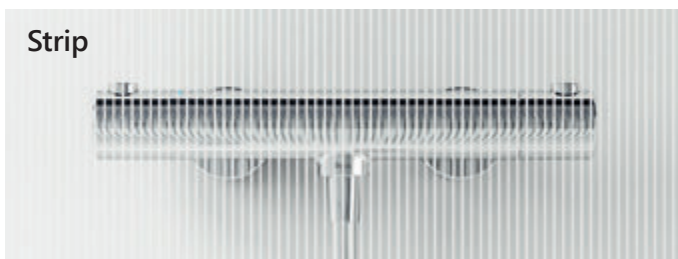

Strip

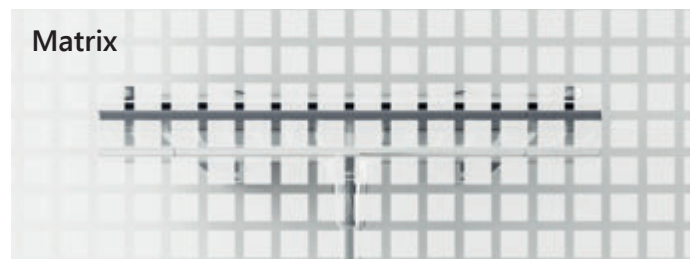

Matrix



Matelux



Grafit

You can find and order our range of glass panels for atypical solutions at <https://atypical.ravak.com>

More about atypical products on p. 32.

Safety glass 31.

The same colour designs and patterns are also available for bath screens. See p. 230.

# Parameters for choosing shower enclosures and doors

## Construction



Brilliant, Walk-In, SmartLine, Chrome

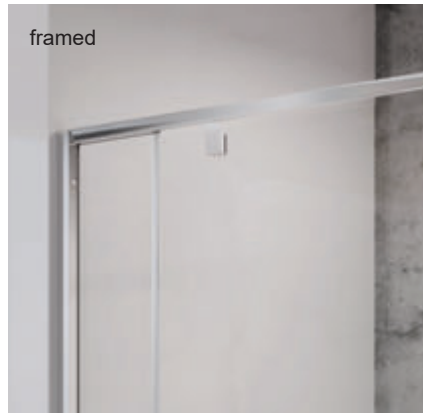

Matrix, 10°, Pivot, Blix Slim, Blix, Supernova

## Shape

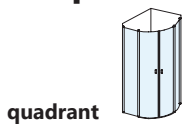

quadrant

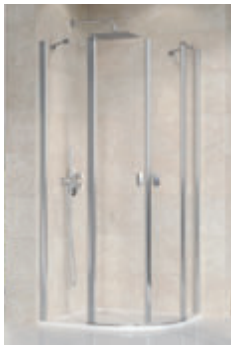

SmartLine, Chrome, Pivot, Blix Slim, Blix, Supernova

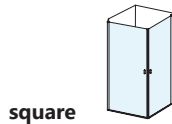

square

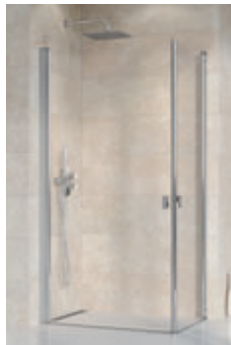

Brilliant, SmartLine, Matrix, 10°, Chrome, Pivot, Blix Slim, Blix, Supernova



rectangle

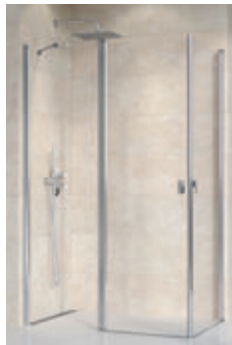

Brilliant, SmartLine, Matrix, 10°, Chrome, Pivot, Blix Slim, Blix, Supernova



doors



Brilliant, SmartLine, Matrix, 10°, Chrome, Pivot, Blix Slim, Blix, Supernova

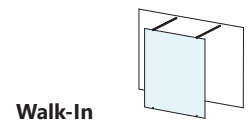

Walk-In



Walk-In

## Type of the opening system

With swivel post – in and out

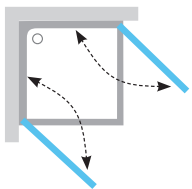

Chrome

Hinged – out

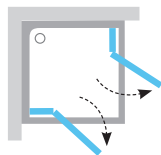

Brilliant, SmartLine

Swinging pivot – out

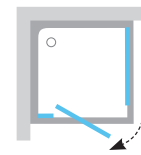

Pivot, Supernova

Folding

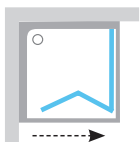

Blix, Supernova

Sliding

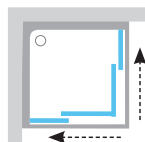

Matrix, 10°, Blix Slim, Blix, Supernova



## Sealing quality

Framed shower enclosures provide optimal protection from water leaking into the bathroom. The taller the bottom horizontal profile, the better the protection. The shower enclosure or door will thus hold water inside the shower enclosure even during intense showering.

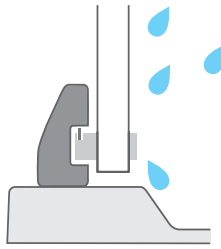

bottom framed shower enclosures  
10°, Pivot, Blix Slim, Blix, Supernova



bottom frameless shower enclosures  
Brilliant, SmartLine, Matrix, Chrome

## Fixing and extension profiles for Pivot, 10°, Blix, Supernova

### Extension profiles

Allows adjusting (expanding) a shower enclosure or door (or bath screen) by exactly 2 cm on each side.

**Extension profiles are available for the following shower enclosure and door lines: Pivot, 10°, Blix and Supernova and for AVDP3 bath door, or APSV bath screen.**

### Fixing profile

Used for mounting the shower enclosure or door to the wall.

**Included with every product that requires it.**



## Fixing profiles Chrome

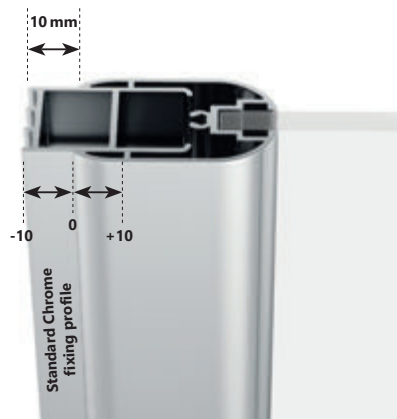

A standard fixing profile is a part of every Chrome product package and allows adjusting (expanding/narrowing) the product by 10 mm.

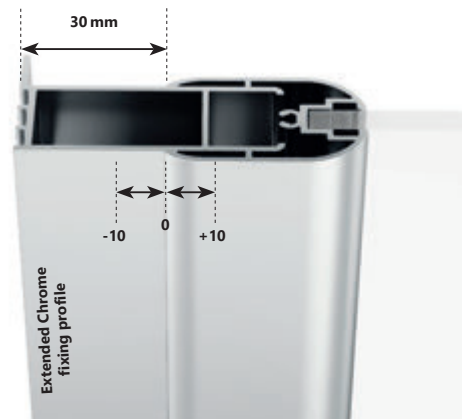

If you need to expand the product more than that, it is necessary to buy a new, extended fixing profile, which is 20 mm wider and allows extending the product by an extra 20 mm, while retaining the +/- 10 mm adjustability.

new



Gloss



Satin



White

Extended fixing profile

## Dimensions and installation

However, if you need to solve height, angled ceilings, openings, non-standard vaults, easy-access entrances and such, feel free to contact us at [export@ravak.com](mailto:export@ravak.com)

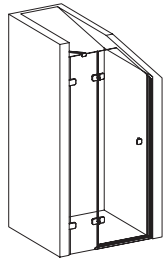

Non-standard shower door in an attic bathroom (slanted wall)

When installing a shower enclosure directly on the floor (without a shower tray), refer to the document entitled Constructional preparation found in the Customised Shower Enclosures section at [www.ravak.com](http://www.ravak.com).

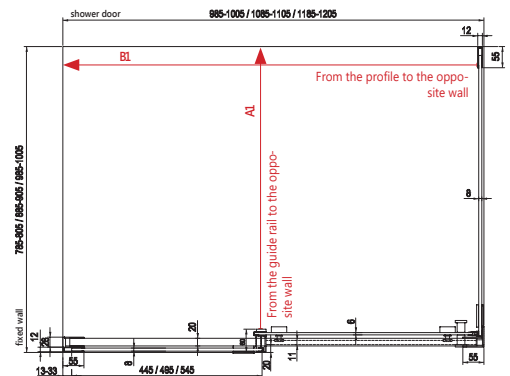

## RAVAK AntiCalc® Technology

"The best service comes directly from the manufacturer."

### An invisible shield against grime and water deposits on glass

Each type of water (except for rain- and distilled water) always contains a certain amount of dissolved mineral salts. When these salts (the so-called limescale) deposit on glass, it can be very difficult to remove them. They create a chemical bond with the glass surface, giving the glass an unsightly tint. Common cleaning products are quite ineffective against limescale.

Only the patented RAVAK AntiCalc® surface treatment technology can reliably protect glass from stable sediments. All RAVAK shower enclosure and screen glass panels are treated with RAVAK AntiCalc® during manufacture.



### RAVAK AntiCalc Conditioner

It is recommended to renew the water-repellent effects of our technology every 3 months (depending on water hardness) by applying RAVAK AntiCalc Conditioner.

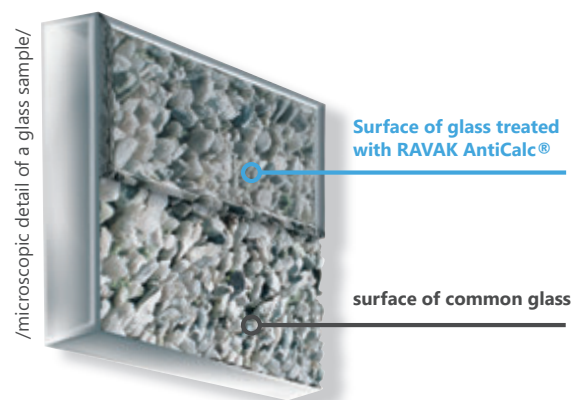

# Custom solution configurator

## Build a product according to your needs - online, from the comfort of your home.

The configurator allows creating atypical designs for shower enclosures, shower doors, fixed screens or bath screens/doors.

Pick a model and select your frame colour or hinge type, glass or plastic panel decor, as well as width, depth and height of the product.

1. SERIES AND TYPE

2. FRAME COLOUR

3. PANELLING DECOR

4. DIMENSIONS



Send the defined product as an order, or find your nearest retailer whom you can consult regarding the selected product and place your order there. More about atypical products at <https://atypical.ravak.com>

Panelling decors for the configurator can be found on p. 28.



Configurator for solutions made-to-measure

Can I help you?  
**+420 318 427 288**  
[export@ravak.com](mailto:export@ravak.com)  
Mo-Fri: 7.00-15.30

INTERNATIONAL

1. Series: MATRIX  
2. Model: MATRIX - MSDPS L  
3. Frame/hinge color: Bright alu  
4. Panel filling: Transparent  
5. Building dimension: 1200 x 900 x 1950 mm  
6. Product configuration

Enter the dimensions of the construction

Width: 1200 mm  
Depth: 900 mm  
Height: 1950 mm

Extent of permitted dimensions:  
Width: 800 - 1600 mm  
Depth: 200 - 1200 mm  
Height: 1000 - 1650, 1660 - 2050 mm

Dimensions note:  
- the building dimension calculated after the panelling  
- product adjustability is from -15 to +5  
- variation from the vertical (wall curvature tolerance) is from -5 to +5  
- product adjustability and variation from the vertical applies to made-to-measure solutions only

< BACK CONTINUE >

Intoressum | Copyright © 2018 - 2020



Need something special?

We can create ramps, cut-outs, non-standard arches

Contact us at [export@ravak.com](mailto:export@ravak.com)

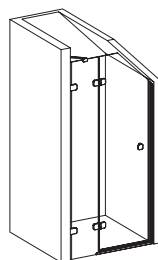

Non-standard shower door in an attic bathroom (slanted wall)



# Overview of solutions for non-standard situations

Product	Model	Min. height	Max. height	Min. width	Max. width	Min. depth	Max. depth	Angled ceilings and openings
<b>BRILLIANT - also allows for walk-in access</b>								
Shower enclosures	BSRV4	1000	2200	700	1400	700	1400	yes
	BSDPS	1000	2200	700	1400	200	1200	yes
Doors	BSD2	1000	2200	740	1450			yes
	BSD3	1000	2200	800	2350			
Bath Screens	BVS2	1000	2200	450	1450			yes
	BVS1			100	1200			yes
<b>WALK-IN - only allows for walk-in access</b>								
Shower enclosures	WALK-IN CORNER	1000	2500	800	1600			yes
	WALK-IN FREE	1000	2500	800	1600			yes
Fixed walls	WALK-IN WALL	1000	2500	800	1600			yes
Combination	WALK-IN COMBINATION	1000	2500	800	1600			yes
<b>SMARTLINE - also allows for walk-in access</b>								
Shower enclosures	SMSKK4	x	only 1900	785	1200	785	1200	yes - but the fixed part only
	SMSRV4	1000	2200	785	1200	785	1200	yes
Doors	SMSD2	1000	2200	890	1200			yes
Fixed walls	SMP5	1000	2200	200	1200			yes
<b>MATRIX - also allows for walk-in access</b>								
Shower enclosures	MSRV4	1000	2050	650	1400	650	1400	no
	MSDPS	1000	2050	800	1600	200	1200	yes - only side fixed wall
Doors	MSD2	1000	2050	800	1600			no
	MSD4	1000	2050	900	2150			no
<b>CHROME</b>								
Shower enclosures	CRV1	1000	2050	400	900			no
	CRV2	1000	2050	700	1600			no
	CRV1+CPS	1000	2050	700	900	200	1200	no
	CRV2+CPS	1000	2050	700	1600	200	1200	no
Doors	CSD1	1000	2050	700	905			no
	CSD2	1000	2050	700	1600			no
<b>PIVOT</b>								
Shower enclosures	PSKK3	x	x	670	1000 - bright alu 1400 - other colours	770	1000 - bright alu 1400 - other colours	no
	PDOP1 + PPS	1000	2050	482	1000	200	1300	PDOP1 - no, PPS - yes
	PDOP2 + PPS			582	1600			PDOP2 - no, PPS - yes
Doors	PDOP1	1000	2050	482	1000			no
	PDOP2			582	1600			no
Fixed walls	PPS	1000	2050	200	1300			yes
Bath Screens	PVS1	1000	2050	100	1300			yes
<b>BLIX</b>								
Shower enclosures	BLCP4	x	x	x	x	x	x	no
	BLRV2K	1000	2050	630	1500	630	1500	no
	BLDP2 + BLPS			800	1600	165	1200	BLDP2 - no, BLPS - yes
Doors	BLDP2	1000	2050	800	1600			no
	BLDP4	1000	2050	1200	2050			
Fixed walls	BLPS	1000	2050	165	1200			yes
<b>SUPERNOVA - also allows for walk-in access</b>								
Shower enclosures	SKKP6	1000	2050					no
	SKCP4	only 1850 (glass)		750	1400	750	1400	no
	SRV2-S			640		640		yes - but the fixed part only
	ASRV3			500	1300	500	1300	yes - but the fixed part only
	ASDP3 + APSS	1000	2050	648	2080		1050 (APSS plastic) 1300 (APSS glass) 2100 (APSS divided)	ASDP3 - yes - but the fixed part only APSS - yes
	SDOP + PSS			463	2050	165		yes
	SDZ2 + PSS				750		1050 (PSS plastic) 1300 (PSS glass) 2100 (PSS divided)	SDZ2 - no, PSS - yes
Doors	SDZ3 + PSS			512	1600			SDZ3 - yes - but the fixed part only PSS - yes
	ASDP3			648	2080			yes - but the fixed part only
	SDOP	1000	2050	463	2050			yes
	SDZ2			512	750			no
Fixed walls	SDZ3			512	1600			yes - but the fixed part only
	APSS							yes
	PSS	1000	2050	165	1050 (plastic) 1300 (glass)			yes
Bath Screens	DSS							yes
	VS2			265	1045			yes - but one part only
	VS3	1000	1500	370				yes - but one part only
	VS5			800	1500			yes - but one part only
	VSK2	only 1500 (glass)		x	x			yes - but one part only
	AVDP3	1000	1500	648	2050			yes - but the fixed part only
	VDKP4			x	x			yes - but the fixed part only

Note: When combining a door with a fixed wall, the min./max. width applies to the shower door and min./max. depth to the fixed wall!

Note: Adjustability of customised products is not the same as adjustability of the catalogue products. Precise adjustment is specified in the customised product card.



The atypical Walk-In Free shower enclosure was tailor-made specifically for a unique bathroom in a hotel resort. Height 250 cm, width 160 cm. Available for order via our online custom solution configurator at <https://atypical.ravak.com>

### Examples of atypical solutions from the Walk-In line

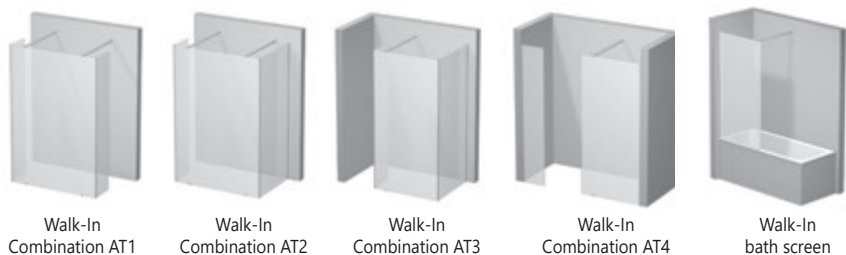

Walk-In Combination AT1

Walk-In Combination AT2

Walk-In Combination AT3

Walk-In Combination AT4

Walk-In bath screen

**Usage possibilities:** Design options of the Walk-In Wall, Corner and Free products can be ordered through the online configurator of the tailor-made solutions ([atypical.ravak.com](https://atypical.ravak.com)), or during a personal consultation when you select the required design (type, width, height). For other design options of Walk-In Combination products, please email us at [export@ravak.com](mailto:export@ravak.com), or they can be discussed in person. For more information go to [www.ravak.com](https://www.ravak.com)



# Wide variety

We offer more than 500 types of shower enclosures in ten model lines.

**Brilliant** p. 38



**Walk-In** p. 44



**10°** p. 62



**Chrome** p. 70



**Pivot** p. 80



5

NOW 5 YEAR WARRANTY  
FOR ALL SHOWER  
ENCLOSURES AND DOORS

SmartLine p. 50



Matrix p. 56



Blix Slim p. 88

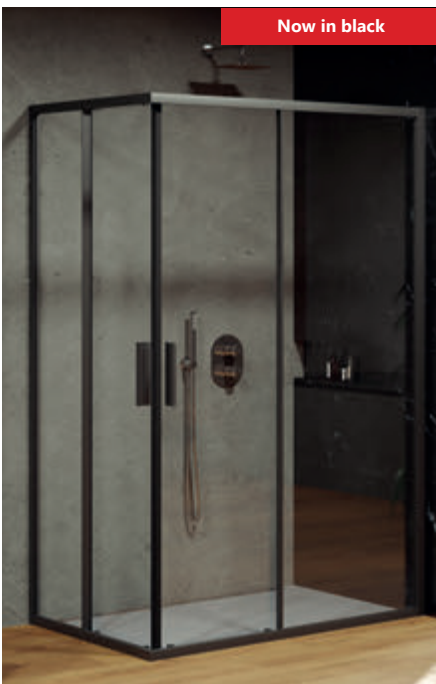

Blix p. 96



Supernova p. 110





Design Kryštof Nosál







# Brilliant

Honed perfection



## Sleek metal fittings

Square, flat shape of metal items distinguishes the Brilliant shower enclosure from all other enclosures on the market.



## Uncompromising quality

Selection of the best materials and precise workmanship.

# Corner shower enclosures



## **BSRV4** - Four-part corner entry shower enclosure

With extra wide entry among corner shower enclosures - entry up to 90 cm wide.

Complement your new shower enclosure by the RAVAK thermostatic faucet which will keep constant temperature of water.

► see p. 389



Sophisticated chrome-plated all-metal hinges, handles and holders enhance the minimalist look of the Brilliant shower enclosures.

## **BSDPS** - Three-part shower enclosure

The largest shower enclosure of this line in a wide choice of sizes. Its dimensions of 90 x 120 cm are ideal for showering of couples.



# Brilliant Shower Door



## **BSD2 - Two-part shower door**

An ideal solution for niches. The shower door is ideal for showering space created out of a bricked niche with a width of 80 - 100cm. It can be adjusted to building imperfections ranging from -10 to +5 mm.

**Choose either left or right hand door option. The option is determined by the location of the door hinges when seen from the outside.**

**New ergonomic handle - pure metal and solid design highlight the stately impression of the entire shower enclosure.**





# Brilliant

**5** NOW 5 YEAR WARRANTY FOR ALL SHOWER ENCLOSURES AND DOORS

**RISE MECHANISM**  
Enables the door to be lifted and locked in the main position

**GLASS PROTECTION**  
The glass is protected by RAVAK AntiCalc® surface treatment technology

## BSRV4 Shower enclosure

Order No.	Type + Panel (glass)	Entrance (mm)	Dimensions (mm)
1UV44A00Z1 D01000A073	BSRV4-80 chrom+glass Transparent ● B SET BSRV4, BSKK4-80,90 chrom	763	783-795x783-795
1UV77A00Z1 D01000A073	BSRV4-90 chrom+glass Transparent ● B SET BSRV4, BSKK4-80,90 chrom	763	883-895x883-895
1UVAA00Z1 D01000A074	BSRV4-100 chrom+glass Transparent ● B SET BSRV4, BSKK4-100 chrom	905	983-995x983-995

Product height 1950 mm.

● B SET BSRV4 80/90 =



● B SET BSRV4 100 =



8/6 mm

GLASS THICKNESS

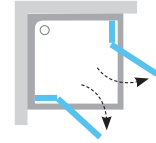
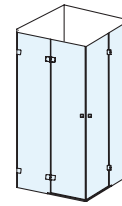

**We recommend:** Install directly onto the floor with an embedded shower channel or floor drain.

**Recommended shower trays:** Perseus, Perseus Pro, Perseus Pro Flat, Perseus Pro Chrome.

## BSDPS Shower enclosure

Order No.	Type + Panel (glass)	Entrance (mm)	Dimensions (mm)
0ULA4A00Z1 D01000A076	BSDPS-80/80 L chrom+glass Transparent ● B SET BSDPS-L 80,90 chrom	527	783-795x783-795
0UP44A00Z1 D01000A075	BSDPS-80/80 R chrom+glass Transparent ● B SET BSDPS-R 80,90 chrom	527	783-795x783-795
0UL77A00Z1 D01000A076	BSDPS-90/90 L chrom+glass Transparent ● B SET BSDPS-L 80,90 chrom	527	883-895x883-895
0UP77A00Z1 D01000A075	BSDPS-90/90 R chrom+glass Transparent ● B SET BSDPS-R 80,90 chrom	527	883-895x883-895
0ULA0A00Z1 D01000A078	BSDPS-100/100 L chrom+glass Transparent ● B SET BSDPS-L 100 chrom	627	983-995x983-995
0UPA0A00Z1 D01000A077	BSDPS-100/100 R chrom+glass Transparent ● B SET BSDPS-R 100 chrom	627	983-995x983-995
0ULA4A00Z1 D01000A078	BSDPS-100/80 L chrom+glass Transparent ● B SET BSDPS-L 100 chrom	627	983-995x783-795
0UPA4A00Z1 D01000A077	BSDPS-100/80 R chrom+glass Transparent ● B SET BSDPS-R 100 chrom	627	983-995x783-795
0ULD4A00Z1 D01000A080	BSDPS-110/80 L chrom+glass Transparent ● B SET BSDPS-L 110 chrom	627	1083-1095x783-795
0UPD4A00Z1 D01000A079	BSDPS-110/80 R chrom+glass Transparent ● B SET BSDPS-R 110 chrom	627	1083-1095x783-795
0ULG4A00Z1 D01000A082	BSDPS-120/80 L chrom+glass Transparent ● B SET BSDPS-L 120 chrom	627	1183-1195x783-795
0UPG4A00Z1 D01000A081	BSDPS-120/80 P chrom+glass Transparent ● B SET BSDPS-R 120 chrom	627	1183-1195x783-795
0ULG7A00Z1 D01000A082	BSDPS-120/90 L chrom+glass Transparent ● B SET BSDPS-L 120 chrom	627	1183-1195x883-895
0UPG7A00Z1 D01000A081	BSDPS-120/90 R chrom+glass Transparent ● B SET BSDPS-R 120 chrom	627	1183-1195x883-895

Product height 1950 mm.

● B SET BSDPS-L/R 80/90 =



● B SET BSDPS-L/R 100/110 =



● B SET BSDPS-L/R 120 =



8/6 mm

GLASS THICKNESS

L/R

L/R OPTION

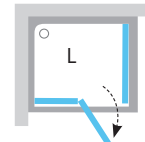
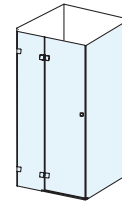

**We recommend:** Install directly onto the floor with an embedded shower channel or floor drain.

**Recommended shower trays:** Perseus Pro, Perseus Pro Flat, Perseus Pro Chrome, Gigant Pro, Gigant Pro Flat, Gigant Pro Chrome.

For details about frames and panels, see page 28. Other design options are available in the Custom Solution Configurator at <https://atypical.ravak.com>

**L (left)** - Left-hand product option, **R (right)** - right-hand product option. The safety glass on the fixed parts has a thickness of 8 mm while the glass on the moving doors is 6 mm thick.

For a complete product, it is necessary to order separately glass panels and separately B SET. Products are as standard delivered within 14 days.

Note: Pay attention to technical documentation before installing your shower enclosure. The number provided in the name of the product does not indicate its exact size. More at [www.ravak.com](http://www.ravak.com).

When installing a shower enclosure directly on the floor (without a shower tray), refer to the document entitled Constructional preparation found in the Customised Shower Enclosures section at [www.ravak.com](http://www.ravak.com).



LIFESPAN TESTED 30 YEARS

High-quality chrome-plated fittings have a minimum life of 30 years

## BSD2 Shower doors (for niches)

Order No.	Type + Panel (glass)	Entrance (mm)	Dimensions (mm)
0UL4AA00Z1	BSD2-80 A-L chrom+glass Transparent (790-805)	529	790-805
D01000A084	○ B SET BSD2-L 80,90 chrom		
0UP4AA00Z1	BSD2-80 A-R chrom+glass Transparent (790-805)	529	790-805
D01000A083	○ B SET BSD2-R 80,90 chrom		
0UL7AA00Z1	BSD2-90 A-L chrom+glass Transparent (890-905)	529	890-905
D01000A084	○ B SET BSD2-L 80,90 chrom		
0UP7AA00Z1	BSD2-90 A-R chrom+glass Transparent (890-905)	529	890-905
D01000A083	○ B SET BSD2-R 80,90 chrom		
0ULAAA00Z1	BSD2-100 A-L chrom+glass Transparent (990-1005)	629	990-1005
D01000A086	● B SET BSD2-L 100 chrom		
0UPAAA00Z1	BSD2-100 A-R chrom+glass Transparent (990-1005)	629	990-1005
D01000A085	● B SET BSD2-R 100 chrom		

Product height 1950 mm.

- B SET BSD2-L/R 80/90 =
- B SET BSD2-L/R 100 =

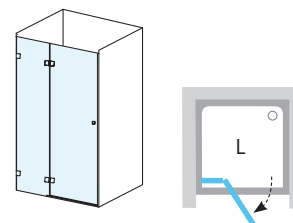

**We recommend:** Install directly onto the floor with an embedded shower channel or floor drain.

**Recommended shower trays:** Perseus, Perseus Pro, Perseus Pro Flat, Perseus Pro Chrome, Gigant, Gigant Pro, Gigant Pro Flat, Gigant Pro Chrome.

**+ B SET =**

**B SET**  
The listed B SETs contain all the necessary metal components for shower enclosures and doors: hinges, fixtures, handle and holders. Includes an assembly kit and, for selected sets, also Brilliant holders.

Maximum stability of the product is ensured by short and long holders of the glass panels, which can also be purchased separately for shower enclosures of smaller sizes.

**Short holder CZK**  
Order No. B19000000A

**Long holder CZK**  
Order No. B20000000A

For details about frames and panels, see page 28. Other design options are available in the Custom Solution Configurator at <https://atypical.ravak.com>

**L (left)** - Left-hand product option, **R (right)** - right-hand product option. The safety glass on the fixed parts has a thickness of 8 mm while the glass on the moving doors is 6 mm thick. For a complete product, it is necessary to order separately glass panels and separately B SET. Products are as standard delivered within 14 days.

Note: Pay attention to technical documentation before installing your shower enclosure. The number provided in the name of the product does not indicate its exact size. More at [www.ravak.com](http://www.ravak.com).

When installing a shower enclosure directly on the floor (without a shower tray), refer to the document entitled Constructional preparation found in the Customised Shower Enclosures section at [www.ravak.com](http://www.ravak.com).

Design Kryštof Nosál







# Walk-In

Life doesn't need  
to be a compromise  
Customised shower  
enclosures



## Safe and effective

The smooth surfaces of solid safety glass combined with subtle shiny bars give the bathroom an airy and classy style.



## Based on the specific needs

Do not let standard shower enclosure dimensions limit your decisions.

# Customised shower enclosures



## **Walk-In Free** - one fixed wall, entry from both sides

A spacious and airy option, which allows two people to shower together.

Select the desired design (type, width and height) and do not let standard dimensions restrict you.  
More at [atypical.ravak.com](http://atypical.ravak.com)



All Walk-in shower enclosure models are also available in black (W SET - brackets, side profiles and supports).

## **Walk-In Corner** - two fixed walls, accessible from one side





**Walk-In Wall** - a fixed wall, side entrance

Solution which will adapt to your requirements.

**Metal bracket** - The Walk-In shower solution includes one or two unobtrusive metal brackets which safely hold the large glass panels in place providing stability to the entire enclosure.



Width of the entrance can be tailored to your needs – max. 110 cm.

**Walk-In Double Wall** - two fixed screens with entrance from one side

Shower enclosure for corners created from two fixed screens. Luxurious shower area with the longest side measuring up to 160 cm.



# Walk-In

5

NOW 5 YEAR WARRANTY FOR ALL SHOWER ENCLOSURES AND DOORS



GLASS PROTECTION  
The glass is protected by RAVAK AntiCalc® surface treatment technology



EASY MAINTENANCE  
No profiles or inaccessible places

## Walk-In Free

Order No.	Type + Panel (glass)
GW9FG0C00Z1	Walk In Free-120 v.200 bright alu+Transparent
GW9FJ0C00Z1	Walk In Free-130 v.200 bright alu+glass Transparent
GW9FM0C00Z1	Walk In Free-140 v.200 bright alu+Transparent
GW9FP0C00Z1	Walk In Free-150 v.200 bright alu+glass Transparent
GW9FS0C00Z1	Walk In Free-160 v.200 bright alu+Transparent

Order No.	Type	Entrance (mm)
GWD01000A096	W SET-90 Free	900
GWD010003020	W SET-90 Free black	900
GWD01000A097	W SET-100 Free	1000
GWD010003021	W SET-100 Free black	1000

Product height 2000 mm.

Finish



8 mm  
GLASS THICKNESS

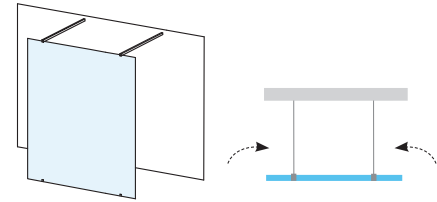

**We recommend:** Install directly onto the floor with an embedded shower channel or floor drain.

**To complete your shower enclosure, it is necessary to order a Walk-In Free glass panel along with W SET Free in your size of choice. The sum will then be the total price of the shower enclosure. The W SET determines the width of the entrance to the shower enclosure from both sides.**

## Walk-In Corner

Order No.	Type + Panel (glass)	Entrance (mm)
GW1CD4C00Z1	Walk In Corner-110/80 v.200 bright alu+Transparent	800
GWD01000A093	W SET-80 Wall/Corner	800
GW1CD4300Z1	Walk In Corner-110/80 v.200 black+Transparent	800
GWD010003017	W SET-80 Wall/Corner black	800
GW1CG4C00Z1	Walk In Corner-120/80 v.200 bright alu+Transparent	800
GWD01000A093	W SET-80 Wall/Corner	800
GW1CG4300Z1	Walk In Corner-120/80 v.200 black+Transparent	800
GWD010003017	W SET-80 Wall/Corner black	800
GW1CG7C00Z1	Walk In Corner-120/90 v.200 bright alu+Transparent	900
GWD01000A094	W SET-90 Wall/Corner	900
GW1CG7300Z1	Walk In Corner-120/90 v.200 black+Transparent	900
GWD010003018	W SET-90 Wall/Corner black	900

Product height 2000 mm.

Finish



8 mm  
GLASS THICKNESS

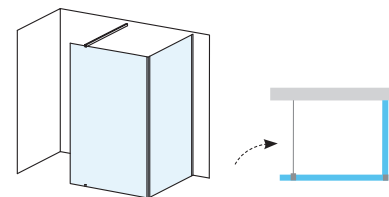

**We recommend:** Install directly onto the floor with an embedded shower channel or floor drain.

+ W SET =

**W SET**  
To buy a complete product from the Walk-In series, it is necessary to buy Walk-In glass fixed screens in one package, and metal supports to hold the shower enclosure together, a so-called W SET, in a second package. The W SET contains metal supports, props and seals.

For details about frames and panels, see page 28. Other design options are available in the Custom Solution Configurator at <https://atypical.ravak.com>

Products listed in the tables have a standard delivery of 14 days. Customised products (outside dimensions in the tables) are delivered within 6 weeks.

Note: Pay attention to technical documentation before installing your shower enclosure. The number provided in the name of the product does not indicate its exact size. More at [www.ravak.com](http://www.ravak.com).

When installing a shower enclosure directly on the floor (without a shower tray), refer to the document entitled Constructional preparation found in the Customised Shower Enclosures section at [www.ravak.com](http://www.ravak.com).

## Walk-In Wall

Order No.	Type + Panel (glass)	Entrance (mm)
GW9W00C00Z1	Walk In Wall-60 v.200 bright alu+ glass Transparent	
GW9W00300Z1	Walk In Wall-60 v.200 black+glass Transparent	
GW9W10C00Z1	Walk In Wall-70 v.200 bright alu+glass Transparent	
GW9W10300Z1	Walk In Wall-70 v.200 black+glass Transparent	
GW9W40C00Z1	Walk In Wall-80 v.200 bright alu+glass Transparent	
GW9W40300Z1	Walk In Wall-80 v.200 black+ glass Transparent	
GW9W70C00Z1	Walk In Wall-90 v.200 bright alu+Transparent	
GW9W70300Z1	Walk In Wall-90 v.200 black+Transparent	
GW9WA0C00Z1	Walk In Wall-100 v.200 bright alu+ Transparent	
GW9WA0300Z1	Walk In Wall-100 v.200 black+ Transparent	
GW9WD0C00Z1	Walk In Wall-110 v.200 bright alu+ Transparent	
GW9WD0300Z1	Walk In Wall-110 v.200 black+ Transparent	
GW9WG0C00Z1	Walk In Wall-120 v.200 bright alu+ Transparent	
GW9WG0300Z1	Walk In Wall-120 v.200 black+ Transparent	
GW9WJ0C00Z1	Walk In Wall-130 v.200 bright alu+ glass Transparent	
GW9WJ0300Z1	Walk In Wall-130 v.200 black+glass Transparent	
GW9WM0C00Z1	Walk In Wall-140 v.200 bright alu+ Transparent	
GW9WM0300Z1	Walk In Wall-140 v.200 black+ Transparent	
GW9WP0C00Z1	Walk In Wall-150 v.200 bright alu+glass Transparent	
GW9WP0300Z1	Walk In Wall-150 v.200 black+glass Transparent	
GW9WS0C00Z1	Walk In Wall-160 v.200 bright alu+glass Transparent	
GW9WS0300Z1	Walk In Wall-160 v.200 black+ glass Transparent	
Order No.	Type	Entrance (mm)
GWD01000A093	W SET-80 Wall/Corner	800
GWD010003017	W SET-80 Wall/Corner black	
GWD01000A094	W SET-90 Wall/Corner	900
GWD010003018	W SET-90 Wall/Corner black	
GWD01000A095	W SET-100 Wall/Corner	1000
GWD010003019	W SET-100 Wall/Corner black	

Product height 2000 mm.

### Finish



8 mm  
GLASS THICKNESS

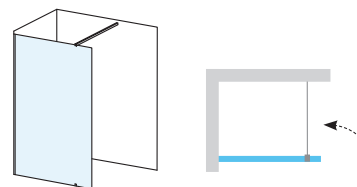

**We recommend:** Install directly onto the floor with an embedded shower channel or floor drain.

**To complete your shower enclosure, it is necessary to order a Walk-In Wall/Corner glass panel along with W SET Wall/Corner in your size of choice. The sum will then be the total price of the shower enclosure. W SET determines the width of the entrance to the shower enclosure.**

## Walk-In Double Wall

Order No.	Type + Panel (glass)	Entrance (mm)
GW9W00C00Z1	Walk In Wall-60 v.200 bright alu+ glass Transparent	
GW9W00300Z1	Walk In Wall-60 v.200 black+glass Transparent	
GW9W10C00Z1	Walk In Wall-70 v.200 bright alu+glass Transparent	
GW9W10300Z1	Walk In Wall-70 v.200 black+glass Transparent	
GW9W40C00Z1	Walk In Wall-80 v.200 bright alu+glass Transparent	
GW9W40300Z1	Walk In Wall-80 v.200 black+ glass Transparent	
GW9W70C00Z1	Walk In Wall-90 v.200 bright alu+Transparent	
GW9W70300Z1	Walk In Wall-90 v.200 black+Transparent	
GW9WA0C00Z1	Walk In Wall-100 v.200 bright alu+ Transparent	
GW9WA0300Z1	Walk In Wall-100 v.200 black+ Transparent	
GW9WD0C00Z1	Walk In Wall-110 v.200 bright alu+ Transparent	
GW9WD0300Z1	Walk In Wall-110 v.200 black+ Transparent	
GW9WG0C00Z1	Walk In Wall-120 v.200 bright alu+ Transparent	
GW9WG0300Z1	Walk In Wall-120 v.200 black+ Transparent	
GW9WJ0C00Z1	Walk In Wall-130 v.200 bright alu+ glass Transparent	
GW9WJ0300Z1	Walk In Wall-130 v.200 black+glass Transparent	
GW9WM0C00Z1	Walk In Wall-140 v.200 bright alu+ Transparent	
GW9WM0300Z1	Walk In Wall-140 v.200 black+ Transparent	
GW9WP0C00Z1	Walk In Wall-150 v.200 bright alu+glass Transparent	
GW9WP0300Z1	Walk In Wall-150 v.200 black+glass Transparent	
GW9WS0C00Z1	Walk In Wall-160 v.200 bright alu+glass Transparent	
GW9WS0300Z1	Walk In Wall-160 v.200 black+ glass Transparent	
Order No.	Type	Entrance (mm)
GWD01000A098	W SET-Uni Free/Wall	
GWD010003023	W SET-Uni Free/Wall black	
GWD01000A099	W SET-Uni T spoj	
GWD010003024	W SET-Uni T spoj black	

Product height 2000 mm.

### Finish



8 mm  
GLASS THICKNESS

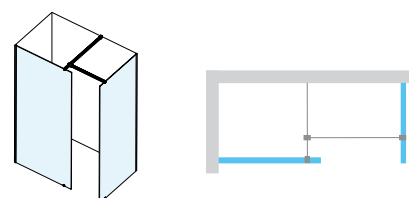

**We recommend:** Install directly onto the floor with an embedded shower channel or floor drain.

**To complete your shower enclosure, it is necessary to order two Walk-In Wall glass panels in your sizes of choice along with W SET-Uni Free/Wall and W SET-Uni T coup. Changing the dimensions of W SET Uni Free/Wall determines the width of the shower space while W SET-Uni T coup. determines the width of the entrance to the shower enclosure. The dimensions of both W SETs can thus be tailored to your needs (1200 mm maximum length).**

For details about frames and panels, see page 28. Other design options are available in the Custom Solution Configurator at <https://atypical.ravak.com>

Products listed in the tables have a standard delivery time of 14 days. Atypical products (with dimensions beyond those listed in the tables) are delivered within 6 weeks.

Note: Pay attention to technical documentation before installing your shower enclosure. The number provided in the name of the product does not indicate its exact size. More at [www.ravak.com](http://www.ravak.com).

When installing a shower enclosure directly on the floor (without a shower tray), refer to the document entitled Constructional preparation found in the Customised Shower Enclosures section at [www.ravak.com](http://www.ravak.com).

Design Kryštof Nosál







# SmartLine

Shiny and minimalist  
bathroom design



## Pure elegance

The glass gently accented with shiny metal components. It underlines the airy and light feel of the entire shower enclosure.



## Precise installation

The dimensions of the shower enclosure can be adjusted to any building imperfections during installation.

## Quadrant shower enclosures



### **SMSKK4** - Four-part quadrant shower enclosure

Balanced design shower enclosure. Large safety glass panels and high-quality chromium-plated fittings - these are the characteristic features of this elegant enclosure.

## Corner shower enclosures



### **SMSRV4** - Four-part corner entry shower enclosure

Features the widest entrance. In its entrance area, it provides the greatest comfort of all products from the SmartLine range.

**Watertightness is guaranteed by a bottom drip-rail and an 18 mm high single-part threshold strip.**



**SMSD2 + SMPS - shower door + fixed wall, with front entry**

A shower enclosure tailored to your needs. Combine the shower door with fixed wall to create a showering space in dimensions from 90 x 80 cm up to 120 x 100 cm.

High-quality chrome-plated hinges reflect the newest trends adding clean and minimalist look to the SmartLine shower enclosures.



Fixing profile - enables easy and accurate mounting of the shower enclosure. It can compensate minor building imperfections of up to 15 mm.

**SMSD2 - Two-part shower door**

An ideal solution for niches. Install the shower door into a niche or create a new showering area by combining the door with the SMPS fixed wall.





# SmartLine

**5** NOW 5 YEAR WARRANTY FOR ALL SHOWER ENCLOSURES AND DOORS

**RISE MECHANISM**  
Enables the door to be lifted and locked in the main position

**GLASS PROTECTION**  
The glass is protected by RAVAK AntiCalc® surface treatment technology

## SMSKK4 Shower enclosure

Order No.	Type + Panel (glass)	Entrance (mm)	Dimensions (mm)
3S244A00Y1	SMSKK4-80 chrom+glass Transparent	761	785-800x785-800
3S277A00Y1	SMSKK4-90 chrom+glass Transparent	761	885-900x885-900

Set of 2 short holders included.  
Product height 1900 mm.

Finish

GLOSS

6 mm

GLASS THICKNESS

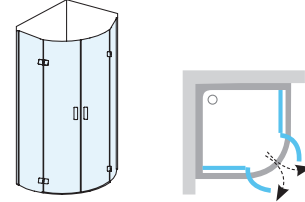

**Recommended shower trays:** Elipso, Elipso Pro, Elipso Pro Flat, Elipso Pro Chrome.

## SMSRV4 Shower enclosure

Order No.	Type + Panel (glass)	Entrance (mm)	Dimensions (mm)
1SV44A00Z1	SMSRV4-80 chrom+glass Transparent	763	785-800x785-800
1SV77A00Z1	SMSRV4-90 chrom+glass Transparent	763	885-900x885-900

Set of 2 short holders included.  
Product height 1900 mm.

Finish

GLOSS

6 mm

GLASS THICKNESS

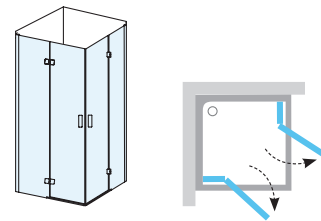

**Recommended shower trays:** Perseus, Perseus Pro, Perseus Pro Flat, Perseus Pro Chrome.

## SMSD2 Shower doors (for niches or in combination with SMPS)

Order No.	Type + Panel (glass)	Entrance (mm)	Dimensions in niche (mm)	Dimensions with SMPS (mm)
OSL7AA00Z1	● SMSD2-90 A-L chrom+glass Transparent	629	889 - 906	885 - 900
OSP7AA00Z1	● SMSD2-90 A-R chrom+glass Transparent			
OSL7BA00Z1	● SMSD2-90 B-L chrom+glass Transparent			
OSP7BA00Z1	● SMSD2-90 B-R chrom+glass Transparent			
OSLAAA00Z1	● SMSD2-100 A-L chrom+glass Transparent	629	989 - 1006	985 - 1000
OSPAAA00Z1	● SMSD2-100 A-R chrom+glass Transparent			
OSLABA00Z1	● SMSD2-100 B-L chrom+glass Transparent			
OSPABA00Z1	● SMSD2-100 B-R chrom+glass Transparent			
OSLDA00Z1	● SMSD2-110 A-L chrom+glass Transparent	629	1089 - 1106	1085 - 1100
OSPDAA00Z1	● SMSD2-110 A-R chrom+glass Transparent			
OSLDBA00Z1	● SMSD2-110 B-L chrom+glass Transparent			
OSPDBA00Z1	● SMSD2-110 B-R chrom+glass Transparent			
OSLGA00Z1	● SMSD2-120 A-L chrom+glass Transparent	629	1189 - 1206	1185 - 1200
OSPGA00Z1	● SMSD2-120 A-R chrom+glass Transparent			
OSLGBA00Z1	● SMSD2-120 B-L chrom+glass Transparent			
OSPGBA00Z1	● SMSD2-120 B-R chrom+glass Transparent			

Model A shower door is designed for a construction opening that is up to 11 mm smaller than the standard size of the product.  
Model B is designed for a construction opening that is up to 16 mm larger than the standard size of the product.  
For example, if your already tiled niche for the shower door has a size of 889 - 906 mm, buy model A, if it has a size of 899 - 916 mm, buy model B.

- 1 short holder included.
- 1 long holder included.

Product height 1900 mm.

Finish

GLOSS

6 mm

GLASS THICKNESS

L/R

L/R OPTION

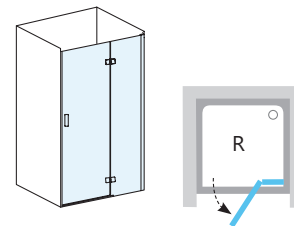

**Recommended shower trays:** Perseus, Perseus Pro, Perseus Pro Flat, Perseus Pro Chrome, Gigant, Gigant Pro, Gigant Pro Flat, Gigant Pro Chrome.

**Usage possibilities:** Door A and B can be used in a niche.  
If combined with a fixed wall, it is necessary to order the B option (**left hand fixed wall for the left hand door, right hand fixed wall for the right hand door**).

For details about frames and panels, see page 28. Other design options are available in the Custom Solution Configurator at <https://atypical.ravak.com>

L (left) - Left-hand product option, R (right) - right-hand product option.

Products are as standard delivered within 14 days.

Note: Pay attention to technical documentation before installing your shower enclosure. The number provided in the name of the product does not indicate its exact size. More at [www.ravak.com](http://www.ravak.com).

When installing a shower enclosure directly on the floor (without a shower tray), refer to the document entitled Constructional preparation found in the Customised Shower Enclosures section at [www.ravak.com](http://www.ravak.com).

**SMPS** Fixed screen

Order No.	Type + Panel (glass)	Dimensions (mm)
9SL40A00Z1	SMPS-80 L chrom+glass Transparent	785-800
9SP40A00Z1	SMPS-80 R chrom+glass Transparent	
9SL70A00Z1	SMPS-90 L chrom+glass Transparent	885-900
9SP70A00Z1	SMPS-90 R chrom+glass Transparent	
9SLA0A00Z1	SMPS-100 L chrom+glass Transparent	985-1000
9SPA0A00Z1	SMPS-100 R chrom+glass Transparent	

1 long holder included.  
Product height 1900 mm.



Finish

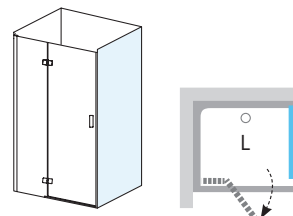

**Recommended shower trays:** Perseus, Perseus Pro, Perseus Pro Flat, Perseus Pro Chrome, Gigant, Gigant Pro, Gigant Pro Flat, Gigant Pro Chrome.

The fixed screen can also be used as a partition, e.g. between the shower area and the rest of the bathroom.

**Usage possibilities:** If combining with SMSD2 doors, it is also necessary to order (left hand fixed wall for the left hand door, right hand fixed wall for the right hand door).

For details about frames and panels, see page 28. Other design options are available in the Custom Solution Configurator at <https://atypical.ravak.com>

**L (left)** - Left-hand product option, **R (right)** - right-hand product option.

Products are as standard delivered within 14 days.

Note: Pay attention to technical documentation before installing your shower enclosure. The number provided in the name of the product does not indicate its exact size. More at [www.ravak.com](http://www.ravak.com).

When installing a shower enclosure directly on the floor (without a shower tray), refer to the document entitled Constructional preparation found in the Customised Shower Enclosures section at [www.ravak.com](http://www.ravak.com).

Design Kryštof Nosál





# Matrix

Open access



## Comfortable entrance

The bottom side is fitted with unobtrusive threshold which does not limit access and leaves the floor integrity.

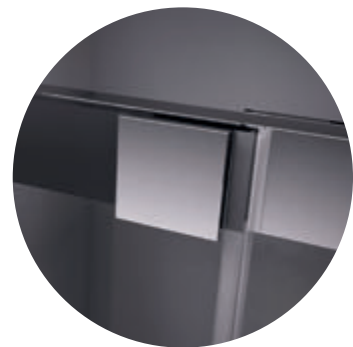

## Design element for maximum stability

A square shape plate characterises the entire shower enclosure and provides also a practical function of hidden fastening of the glass.



# Corner shower enclosures



## **MSRV4** - Four-part corner entry sliding shower enclosure

Square-shaped shower enclosure with a wide corner entrance.

Lower threshold strip with a fixation guide rail which replaces the lower profile. The Matrix enclosure looks so light and airy.

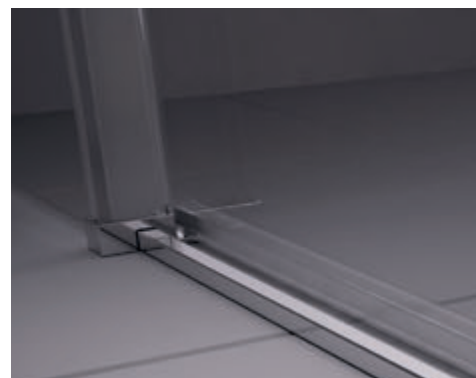

## **MSDPS** - shower door and fixed wall with front entry

This modern corner-shaped shower enclosure offers more space for showering.



## Shower Door

**MSD2 - Two-part sliding shower door**

Space for showering up to 120 cm wide. Choose the left or right hand option. The door cannot be reversed additionally.

Guaranteed easy opening of the large surface of the shower door, not only from the outside but also from the inside. Solid metallic material that lasts.

**MSD4 - Four-part sliding shower door**

Niche shower doors. Can partition an area up to 200 cm wide. Ideal for creating a spacious, low-threshold shower enclosure.

► Design on p. 60-61



# Matrix

**5** NOW 5 YEAR WARRANTY  
FOR ALL SHOWER  
ENCLOSURES AND DOORS

 EASY MAINTENANCE  
Minimum profiles and  
no unreachable spots

 GLASS PROTECTION  
The glass is protected by RAVAK  
AntiCalc® surface treatment technology

## MSRV4 Shower enclosure

Order No.	Type + Panel (glass)	Entrance (mm)	Dimensions (mm)
1WV44100Z1	MSRV4-80/80 white+Transparent	430	785-805x785-805
1WV44C00Z1	MSRV4-80/80 bright alu+Transparent		
1WV44U00Z1	MSRV4-80/80 satin+Transparent		
1WV77100Z1	MSRV4-90/90 white+Transparent	500	885-905x885-905
1WV77C00Z1	MSRV4-90/90 bright alu+Transparent		
1WV77U00Z1	MSRV4-90/90 satin+Transparent		
1WVAA100Z1	MSRV4-100/100 white+Transparent	570	985-1005x985-1005
1WVAA00Z1	MSRV4-100/100 bright alu+Transparent		
1WVAAU00Z1	MSRV4-100/100 satin+Transparent		

Product height 1950 mm.

Finish

GLOSS SATIN WHITE

8/6  
mm

GLASS THICKNESS

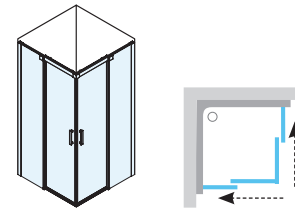

**We recommend:** Install directly onto the floor with an embedded shower channel or floor drain. If combining with a shower tray, we recommend the Perseus Pro Chrome tray.

## MSDPS Shower enclosure

Order No.	Type + Panel (glass)	Entrance (mm)	Dimensions (mm)
0WLA4100Z1	MSDPS-100/80 L white+Transparent	429	985-1005x785-805
0WPA4100Z1	MSDPS-100/80 R white+Transparent		
0WLA4C00Z1	MSDPS-100/80 L bright alu+Transparent		
0WPA4C00Z1	MSDPS-100/80 R bright alu+Transparent		
0WLA4U00Z1	MSDPS-100/80 L satin+Transparent		
0WPA4U00Z1	MSDPS-100/80 R satin+Transparent		
0WLA4100Z1	MSDPS-100/100 L white+Transparent	429	985-1005x985-1005
0WPA4100Z1	MSDPS-100/100 R white+Transparent		
0WLA4C00Z1	MSDPS-100/100 L bright alu+Transparent		
0WPA4C00Z1	MSDPS-100/100 R bright alu+Transparent		
0WLA4U00Z1	MSDPS-100/100 L satin+Transparent		
0WPA4U00Z1	MSDPS-100/100 R satin+Transparent		
0WLD4100Z1	MSDPS-110/80 L white+Transparent	479	1085-1105x785-805
0WPD4100Z1	MSDPS-110/80 R white+Transparent		
0WLD4C00Z1	MSDPS-110/80 L bright alu+Transparent		
0WPD4C00Z1	MSDPS-110/80 R bright alu+Transparent		
0WLD4U00Z1	MSDPS-110/80 L satin+Transparent		
0WPD4U00Z1	MSDPS-110/80 R satin+Transparent		
0WLG4100Z1	MSDPS-120/80 L white+Transparent	529	1185-1205x785-805
0WPG4100Z1	MSDPS-120/80 R white+Transparent		
0WLG4C00Z1	MSDPS-120/80 L bright alu+Transparent		
0WPG4C00Z1	MSDPS-120/80 R bright alu+Transparent		
0WLG4U00Z1	MSDPS-120/80 L satin+Transparent		
0WPG4U00Z1	MSDPS-120/80 R satin+Transparent		
0WLG7100Z1	MSDPS-120/90 L white+Transparent	529	1185-1205x885-905
0WPG7100Z1	MSDPS-120/90 R white+Transparent		
0WLG7C00Z1	MSDPS-120/90 L bright alu+Transparent		
0WPG7C00Z1	MSDPS-120/90 R bright alu+Transparent		
0WLG7U00Z1	MSDPS-120/90 L satin+Transparent		
0WPG7U00Z1	MSDPS-120/90 R satin+Transparent		

Product height 1950 mm.

Finish

GLOSS SATIN WHITE

8/6  
mm

GLASS THICKNESS

L/R

L/R OPTION

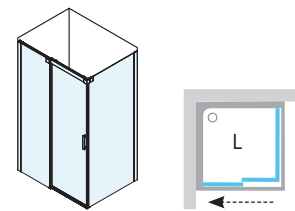

**We recommend:** Install directly onto the floor with an embedded shower channel or floor drain. If combining with a shower tray, we recommend the Gigant Pro Chrome tray.

For details about frames and panels, see page 28. Other design options are available in the Custom Solution Configurator at <https://atypical.ravak.com>

L (left) - Left-hand product option, R (right) - right-hand product option. The safety glass on the fixed parts has a thickness of 8 mm while the glass on the moving doors is 6 mm thick.

Products are as standard delivered within 14 days.

Note: Pay attention to technical documentation before installing your shower enclosure. The number provided in the name of the product does not indicate its exact size. More at [www.ravak.com](http://www.ravak.com).

When installing a shower enclosure directly on the floor (without a shower tray), refer to the document entitled Constructional preparation found in the Customised Shower Enclosures section at [www.ravak.com](http://www.ravak.com).

**MSD2** Shower doors (for niches)

Order No.	Type + Panel (glass)	Entrance (mm)	Dimensions (mm)
OWLA0100Z1	MSD2-100 L white+Transparent	414	975-1015
OWPA0100Z1	MSD2-100 R white+Transparent		
OWLA0C00Z1	MSD2-100 L bright alu+Transparent		
OWPA0C00Z1	MSD2-100 R bright alu+Transparent		
OWLA0U00Z1	MSD2-100 L satin+Transparent		
OWPA0U00Z1	MSD2-100 R satin+Transparent		
OWLD0100Z1	MSD2-110 L white+Transparent	464	1075-1115
OWPD0100Z1	MSD2-110 R white+Transparent		
OWLD0C00Z1	MSD2-110 L bright alu+Transparent		
OWPD0C00Z1	MSD2-110 R bright alu+Transparent		
OWLD0U00Z1	MSD2-110 L satin+Transparent		
OWPD0U00Z1	MSD2-110 R satin+Transparent		
OWLG0100Z1	MSD2-120 L white+Transparent	514	1175-1215
OWPG0100Z1	MSD2-120 R white+Transparent		
OWLG0C00Z1	MSD2-120 L bright alu+Transparent		
OWPG0C00Z1	MSD2-120 R bright alu+Transparent		
OWLG0U00Z1	MSD2-120 L satin+Transparent		
OWPG0U00Z1	MSD2-120 R satin+Transparent		

Product height 1950 mm.

## Finish

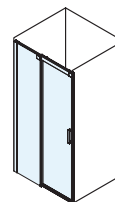

**We recommend:** Install directly onto the floor with an embedded shower channel or floor drain. If combining with a shower tray, we recommend the Perseus Pro Chrome or Gigant Pro Chrome trays.

**MSD4** Shower doors (for niches)

Order No.	Type + Panel (glass)	Entrance (mm)	Dimensions (mm)
OWKM0100Z1	■ MSD4-140 white+Transparent	580	1375-1415
OWKM0U00Z1	■ MSD4-140 satin+Transparent		
OWKM0C00Z1	■ MSD4-140 bright alu+Transparent		
OWKS0100Z1	■ MSD4-160 white+Transparent	680	1575-1615
OWKS0U00Z1	■ MSD4-160 satin+Transparent		
OWKS0C00Z1	■ MSD4-160 bright alu+Transparent		
OWKY0100Z1	■ MSD4-180 white+Transparent	780	1775-1815
OWKY0C00Z1	■ MSD4-180 bright alu+Transparent		
OWKY0U00Z1	■ MSD4-180 satin+Transparent		
OWKK0100Z1	■ MSD4-200 white+Transparent	880	1975-2015
OWKK0U00Z1	■ MSD4-200 satin+Transparent		
OWKK0C00Z1	■ MSD4-200 bright alu+Transparent		

Product height 1950 mm.

■ 6 week delivery time.

## Finish

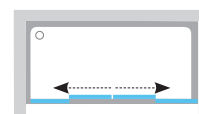
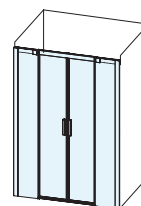
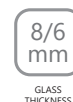

**We recommend:** Install directly onto the floor with an embedded shower channel or floor drain.

For details about frames and panels, see page 28. Other design options are available in the Custom Solution Configurator at <https://atypical.ravak.com>

**L (left)** - Left-hand product option, **R (right)** - right-hand product option. The safety glass on the fixed parts has a thickness of 8 mm while the glass on the moving doors is 6 mm thick.

Products are as standard delivered within 14 days.

Note: Pay attention to technical documentation before installing your shower enclosure. The number provided in the name of the product does not indicate its exact size. More at [www.ravak.com](http://www.ravak.com).

When installing a shower enclosure directly on the floor (without a shower tray), refer to the document entitled Constructional preparation found in the Customised Shower Enclosures section at [www.ravak.com](http://www.ravak.com).

Design Kryštof Nosál







# 10°

One of a kind on the market



Sophisticated author's design

Playing with the 10° angle provides more aesthetic appeal.



New benefits

The subtle corner from the outside makes movement around the enclosure much easier, while providing the comfort of a large rectangular enclosure on the inside. In addition, it offers new storage areas on the shower tray.

# Corner shower enclosures



## **10AP4 - Four-part corner entry sliding shower enclosure**

Asymmetrical shower enclosure - unique by its slanted angle. The rectangle on the tray surface saves space in the bathroom, yet allows comfortable showering and unveils new storage areas inside the shower enclosure.

**The chrome connector is part of all the colour options of the frames.**



**Quality manufacturing of the metal chromed handle enabled the creation of a unique design.**

## **10RV2 - Four-part corner entry sliding shower enclosure**

Offers comfortable entrance width; the sliding doors take up no space in the bathroom. Available in the most popular sizes of 80 and 90 cm. Its design perfectly matches the other bathroom equipment from the 10° concept.



# Corner Shower Enclosures and Door

## 10RV2K + 10RV2K - Four-part corner entry sliding shower enclosure

To obtain a square-shaped or a rectangular-shaped shower enclosure with central entry, combine different sizes of the 10RV2K product.

**Gigant Pro 10° shower tray with practical shelf space outside of the stepping zone** see p. 139.



**Tilting door mechanism** - allows access to otherwise hard-to-reach areas when cleaning.

## 10DP4 - Four-part sliding shower door

Ideal even for extra wide niches. Can screen off an area of up to 200cm in width, but offers a number of variants already from 120cm upwards. Time-proven sliding door system ensures silent running of individual door parts without jamming or crossing.

► Design on p. 67-69





# Shower Door



## **10DP2 - Two-part sliding shower door**

Ideal solution for niches; can screen off an area of up to 120 cm in width. The door can be flipped for right- or left-sided installation and can be combined with a fixed screen. Extension profiles available for widening by up to 4 cm on each side.

**10° shower channel - for seamless design of a ceramic floor see p. 156.**

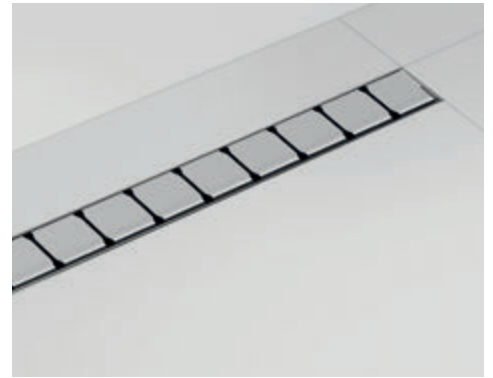

## **10DP2 + 10PS - shower door + fixed wall, with front entry**

A number of size variants. Adapt the shower enclosure to the size of the bathroom. Shower area from 100 x 80 cm to up to 120 x 100 cm.

# 10°

5

NOW 5 YEAR WARRANTY FOR ALL SHOWER ENCLOSURES AND DOORS



CONCEPTS  
Items in perfect harmony



TILTING GLASS  
Easy cleaning of hard-to-reach places

## 10AP4 Shower enclosure

Order No.	Type + Panel (glass)	Entrance (mm)	Dimensions (mm)
0ZVG70100Z1	10AP4-120/90 white+Transparent	620	1180-1200 x 880-900 x 682-702
0ZVG70C00Z1	10AP4-120/90 bright alu+Transparent		
0ZVG70U00Z1	10AP4-120/90 satin+Transparent		

Product height 1900 mm.  
The height of the product will be changed during the year to 1950 mm.

### Finish

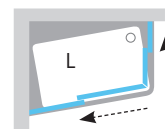
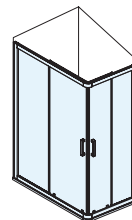

**Recommended shower trays:** Asymmetric Pro 10°

Adjusting profile can be used on the shorter side.

## 10RV2 Shower enclosure

Order No.	Type + Panel (glass)	Entrance (mm)	Dimensions (mm)
1ZI40100Z1	10RV2-80 white+Transparent	431	780-800
1ZI40C00Z1	10RV2-80 bright alu+Transparent		
1ZI40U00Z1	10RV2-80 satin+Transparent		
1ZI70100Z1	10RV2-90 white+Transparent	502	880-900
1ZI70C00Z1	10RV2-90 bright alu+Transparent		
1ZI70U00Z1	10RV2-90 satin+Transparent		

Product height 1900 mm.  
The height of the product will be changed during the year to 1950 mm.

### Finish

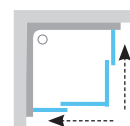

**Recommended shower trays:** Angela, Perseus, Perseus Pro, Perseus Pro Flat, Perseus Pro Chrome, Perseus Pro 10°.

## 10RV2K + 10RV2K Shower enclosure

Order No.	Type + Panel (glass)	Entrance (mm)	Dimensions (mm)
1ZJ40100Z1	10RV2K-80 white+Transparent	431	780-800
1ZJ40C00Z1	10RV2K-80 bright alu+Transparent		
1ZJ40U00Z1	10RV2K-80 satin+Transparent		
1ZJ70100Z1	10RV2K-90 white+Transparent	502	880-900
1ZJ70C00Z1	10RV2K-90 bright alu+Transparent		
1ZJ70U00Z1	10RV2K-90 satin+Transparent		
1ZJA0100Z1	10RV2K-100 white+Transparent	573	980-1000
1ZJA0C00Z1	10RV2K-100 bright alu+Transparent		
1ZJA0U00Z1	10RV2K-100 satin+Transparent		
1ZJD0100Z1	10RV2K-110 white+Transparent	644	1080-1100
1ZJD0C00Z1	10RV2K-110 bright alu+Transparent		
1ZJD0U00Z1	10RV2K-110 satin+Transparent		
1ZJG0100Z1	10RV2K-120 white+Transparent	715	1180-1200
1ZJG0C00Z1	10RV2K-120 bright alu+Transparent		
1ZJG0U00Z1	10RV2K-120 satin+Transparent		

Note: The entrance specified applies to a matching combination of two sizes.  
Product height 1900 mm.  
The height of the product will be changed during the year to 1950 mm.

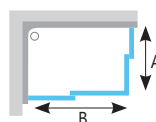

### Finish

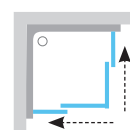
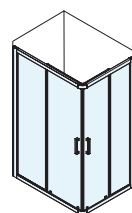

**Recommended shower trays:** Angela, Perseus, Perseus Pro, Perseus Pro Flat, Perseus Pro Chrome.

### Possible combination:

A – 10RV2K – custom size 80 – 120 cm,  
B – 10RV2K – custom size 80 – 120 cm.  
For more comfortable showering, choose size 80 x 120 cm.

To complete your shower enclosure, it is necessary to always order at least two 10RV2K products. The sum will then be the total price of the shower enclosure. The product cannot be used separately as a shower door or in combination with a fixed screen!

For details about frames and panels, see page 28. Other design options are available in the Custom Solution Configurator at <https://atypical.ravak.com>

Frames of all options have chrome connectors.

Products are as standard delivered within 14 days.

Note: Pay attention to technical documentation before installing your shower enclosure. The number provided in the name of the product does not indicate its exact size. More at [www.ravak.com](http://www.ravak.com).

When installing a shower enclosure directly on the floor (without a shower tray), refer to the document entitled Constructional preparation found in the Customised Shower Enclosures section at [www.ravak.com](http://www.ravak.com).

5

NOW 5 YEAR WARRANTY  
FOR ALL SHOWER  
ENCLOSURES AND DOORS



CONCEPTS  
Items in perfect harmony



TILTING GLASS  
Easy cleaning of hard-to-reach places

## 10DP4 Shower doors (for niches or in combination with a fixed screen)

Order No.	Type + Panel (glass)	Entrance (mm)	Dimensions (mm)
0ZKG0100Z1	10DP4-120 white+Transparent		
0ZKG0C00Z1	10DP4-120 bright alu+Transparent	498	1180-1220
0ZKG0U00Z1	10DP4-120 satin+Transparent		
0ZKJ0100Z1	■ 10DP4-130 white+Transparent		
0ZKJ0C00Z1	■ 10DP4-130 bright alu+Transparent	548	1280-1320
0ZKJ0U00Z1	■ 10DP4-130 satin+Transparent		
0ZKM0100Z1	■ 10DP4-140 white+Transparent		
0ZKM0C00Z1	■ 10DP4-140 bright alu+Transparent	598	1380-1420
0ZKM0U00Z1	■ 10DP4-140 satin+Transparent		
0ZKP0100Z1	■ 10DP4-150 white+Transparent		
0ZKP0C00Z1	■ 10DP4-150 bright alu+Transparent	648	1480-1520
0ZKP0U00Z1	■ 10DP4-150 satin+Transparent		
0ZKS0100Z1	■ 10DP4-160 white+Transparent		
0ZKS0C00Z1	■ 10DP4-160 bright alu+Transparent	698	1580-1620
0ZKS0U00Z1	■ 10DP4-160 satin+Transparent		
0ZKV0100Z1	■ 10DP4-170 white+Transparent		
0ZKV0C00Z1	■ 10DP4-170 bright alu+Transparent	748	1680-1720
0ZKV0U00Z1	■ 10DP4-170 satin+Transparent		
0ZKY0100Z1	■ 10DP4-180 white+Transparent		
0ZKY0C00Z1	■ 10DP4-180 bright alu+Transparent	798	1780-1820
0ZKY0U00Z1	■ 10DP4-180 satin+Transparent		
0ZKL0100Z1	■ 10DP4-190 white+Transparent		
0ZKL0C00Z1	■ 10DP4-190 bright alu+Transparent	848	1880-1920
0ZKL0U00Z1	■ 10DP4-190 satin+Transparent		
0ZKK0100Z1	■ 10DP4-200 white+Transparent		
0ZKK0C00Z1	■ 10DP4-200 bright alu+Transparent	898	1980-2020
0ZKK0U00Z1	■ 10DP4-200 satin+Transparent		

■ 6 week delivery time.

Product height 1900 mm.

The height of the product will be changed during the year to 1950 mm.

Finish



EXTENSION PROFILE



GLASS THICKNESS

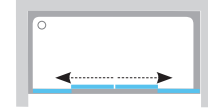
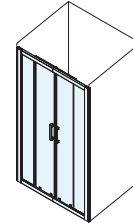

**Recommended shower trays:** Gigant, Gigant Pro, Gigant Pro Flat, Gigant Pro Chrome, Gigant Pro 10°.

## 10DP2 Shower doors (for niches or in combination with a fixed screen)

Order No.	Type + Panel (glass)	Entrance (mm)	Dimensions (mm)
0ZVA0100Z1	10DP2-100 white+Transparent		
0ZVA0C00Z1	10DP2-100 bright alu+Transparent	416	982-1022
0ZVA0U00Z1	10DP2-100 satin+Transparent		
0ZVD0100Z1	10DP2-110 white+Transparent		
0ZVD0C00Z1	10DP2-110 bright alu+Transparent	466	1082-1122
0ZVD0U00Z1	10DP2-110 satin+Transparent		
0ZVG0100Z1	10DP2-120 white+Transparent		
0ZVG0C00Z1	10DP2-120 bright alu+Transparent	516	1182-1222
0ZVG0U00Z1	10DP2-120 satin+Transparent		

Product height 1900 mm.

The height of the product will be changed during the year to 1950 mm.

Finish



EXTENSION PROFILE



GLASS THICKNESS



L/R OPTION

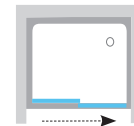
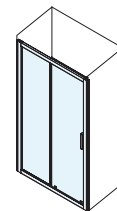

**Recommended shower trays:** Perseus, Perseus Pro, Perseus Pro Chrome, Perseus Pro 10°, Gigant, Gigant Pro, Gigant Pro Flat, Gigant Pro Chrome, Gigant Pro 10°.

For details about frames and panels, see page 28. Other design options are available in the Custom Solution Configurator at <https://atypical.ravak.com>

Frames of all options have chrome connectors.

Products are as standard delivered within 14 days.

Note: Pay attention to technical documentation before installing your shower enclosure. The number provided in the name of the product does not indicate its exact size. More at [www.ravak.com](http://www.ravak.com).

When installing a shower enclosure directly on the floor (without a shower tray), refer to the document entitled Constructional preparation found in the Customised Shower Enclosures section at [www.ravak.com](http://www.ravak.com).





GLASS PROTECTION

The glass is protected by RAVAK AntiCalc® surface treatment technology

**10PS** Fixed screen (for combining with 10DP2 or 10DP4)

Order No.	Type + Panel (glass)	Dimensions (mm)
9UV40100Z1	10PS-80 white+Transparent	780-805
9UV40C00Z1	10PS-80 bright alu+Transparent	
9UV40U00Z1	10PS-80 satin+Transparent	
9UV70100Z1	10PS-90 white+Transparent	880-905
9UV70C00Z1	10PS-90 bright alu+Transparent	
9UV70U00Z1	10PS-90 satin+Transparent	
9UVA0100Z1	10PS-100 white+Transparent	980-1005
9UVA0C00Z1	10PS-100 bright alu+Transparent	
9UVA0U00Z1	10PS-100 satin+Transparent	

Product height 1900 mm.  
The height of the product will be changed during the year to 1950 mm.

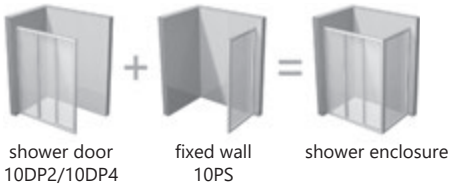

Finish

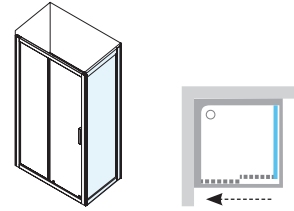

**Recommended shower trays:** Perseus, Perseus Pro, Perseus Pro Flat, Perseus Pro Chrome, Perseus Pro 10°, Gigant, Gigant Pro, Gigant Pro Flat, Gigant Pro Chrome, Gigant Pro 10°.

**BLNPS** Extension profile

Order No.	Type	Height (mm)
E77880111900B	BLNPS white	1900
E778801C1900B	BLNPS bright alu	
E778801U1900B	BLNPS satin	

Can be used for all 10° products except for the longest side (1200mm) of enclosure 10AP4.

Finish

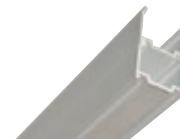

Helps level out structural imperfections. Widens the shower enclosure or door by 2 cm on each side.

**Fixing profiles and extension profiles**

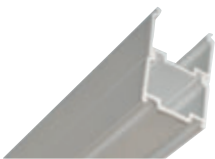

**Extension profiles**  
Make it possible to extend the shower enclosure or door by 2 cm on each side.  
**Extension profiles are available for the following ranges: Pivot, 10°, Blix, and Supernova.**



**Fixing profile**  
Used for mounting the shower enclosure or door to the wall.  
**Not sold separately, this profile is included as standard with any product where necessary.**

For details about frames and panels, see page 28. Other design options are available in the Custom Solution Configurator at <https://atypical.ravak.com>

Frames of all options have chrome connectors.

Products are as standard delivered within 14 days.

Note: Pay attention to technical documentation before installing your shower enclosure. The number provided in the name of the product does not indicate its exact size. More at [www.ravak.com](http://www.ravak.com).

When installing a shower enclosure directly on the floor (without a shower tray), refer to the document entitled Constructional preparation found in the Customised Shower Enclosures section at [www.ravak.com](http://www.ravak.com).

Design Kryštof Nosál





# Chrome

Has a sense of detail



## Open to other options

With its design, it links to more than 250 components of the whole Chrome bathroom concept.



## Door as a beneficial factor

The door post rotates both inside and outside to keep the bathroom dry. Water dripping from the door is drained into the enclosure and not on the ground which would increase the risk of slipping.



## Quadrant shower enclosures



### **CSKK4** - Four-part quadrant shower enclosure

This frameless shower enclosure features practical rotary columns in place of door hinges. Both door leaves can be opened, offering an exceptionally wide entrance.

## Corner shower enclosures



### **CRV1 + CRV1** - Corner entry shower enclosure

Combine two shower doors to obtain a square or rectangular shower enclosure. The door can be combined with a fixed wall.

The Chrome Concept offers a complete design solution for a small as well as large bathroom.



**CRV2 + CPS** - shower door + fixed wall, with front entry

You can also combine the shower door CRV1 or CRV2 with the fixed wall, next to which you can easily place a washbasin or washing machine.

Maximum stability of the product is provided by the fixed wall bracket with variable adjustment. It has a unique jointed design.



The harmonious oval shape blends into all elements, such as the handle, the rotary side post of the door, and the fixed wall bracket, combining them into a perfect aesthetic group. The handle turned upwards is easy to operate and can also be used as a towel hook.

**CRV2 + CRV2** - Corner entry shower enclosure

To create a square or rectangular shower enclosure, combine different dimensions of the CRV2 product.

► Design on p. 76-78

Complete product - combination of the CRV2-110 and CPS-80 models



# Shower Door



## **CSD1 - Single-part shower door**

The door opens both in and out, which makes airing of the enclosure after showering much easier. Water can drip inside the shower enclosure. The door cannot be combined with a fixed wall.

For maximum comfort, add the folding seat to the shower enclosure. It will be excellent for relaxation, but also as a support when shaving legs. see p. 130.



Water tightness is guaranteed by a bottom drip-rail and a 10 mm high threshold strip.

## **CSD2 - Two-part shower door**

The rotary post, which replaces door hinges, adds a unique stability and flexibility in the possibility of opening the door in and out. The door cannot be combined with a fixed wall.





### **CSDL2 - Two-part shower door**

The swing door boasts exceptionally wide entry of up to 102 cm. It provides perfect airing of the whole showering space.

The door cannot be combined with a fixed wall.

Optionally, your shower enclosure can be equipped with a bathtub faucet with a swinging spout which saves space and allows you to fill a bucket.

► see p. 374



# Chrome

**5** NOW 5 YEAR WARRANTY FOR ALL SHOWER ENCLOSURES AND DOORS

**CONCEPTS**  
Items in perfect harmony

**RISE MECHANISM**  
Enables the door to be lifted and locked in the main position

## CSKK4 Shower enclosure

Order No.	Type + Panel (glass)	Entrance (mm)	Dimensions (mm)
3Q140100Z1	CSKK4-80 white+Transparent	635	780-800x780-800
3Q140C00Z1	CSKK4-80 bright alu+Transparent		
3Q140U00Z1	CSKK4-80 satin+Transparent		
3Q170100Z1	CSKK4-90 white+Transparent	635	880-900x880-900
3Q170C00Z1	CSKK4-90 bright alu+Transparent		
3Q170U00Z1	CSKK4-90 satin+Transparent		

2 metal brackets included.  
Product height 1950 mm.

### Finish

GLOSS SATIN WHITE

6 mm

GLASS THICKNESS

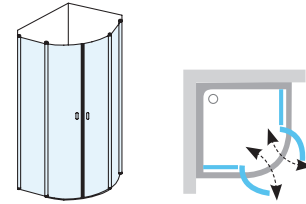

**Recommended shower trays:** Elipso Pro, Elipso Pro Flat, Elipso Pro Chrome.

## CRV1 + CRV1 Shower enclosure

Order No.	Type + Panel (glass)	Entrance (mm)	Dimensions (mm)
1QV40101Z1	CRV1-80 white+ glass Transparent	969	780-800
1QV40C01Z1	CRV1-80 bright alu +glass Transparent		
1QV40U01Z1	CRV1-80 satin + glass Transparent		
1QV70101Z1	CRV1-90 white+glass Transparent	1110	880-900
1QV70C01Z1	CRV1-90 bright alu+glass Transparent		
1QV70U01Z1	CRV1-90 satin+glass Transparent		
1QVA0101Z1	CRV1-100 white+glass Transparent	1251	980-1000
1QVA0C01Z1	CRV1-100 bright alu+glass Transparent		
1QVA0U01Z1	CRV1-100 satin+glass Transparent		

Note: The entrance specified applies to a matching combination of two sizes.  
Product height 1950 mm.

### Finish

GLOSS SATIN WHITE

6 mm

GLASS THICKNESS

180°  
L/R OPTION

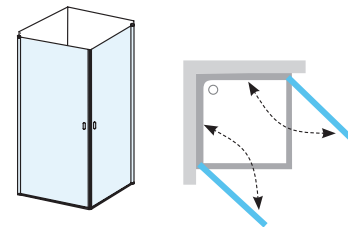

**Recommended shower trays:** Perseus Pro, Perseus Pro Flat, Perseus Pro Chrome, Gigant, Gigant Pro, Gigant Pro Flat, Gigant Pro Chrome.

### Possible combination:

A - CRV1 - choose dimensions 80 - 100 cm  
B - CRV1 - choose dimensions 80 - 100 cm

To complete your shower enclosure, it is necessary to always order at least two CRV1 products. The sum will then be the total price of the shower enclosure. CRV1 can also be combined with CRV2 or the CPS fixed screen.

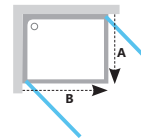

## CRV2 + CRV2 Shower enclosure

Order No.	Type + Panel (glass)	Entrance (mm)	Dimensions (mm)
1QV40100Z1	CRV2-80 white+Transparent	635	780-800
1QV40C00Z1	CRV2-80 bright alu+Transparent		
1QV40U00Z1	CRV2-80 satin+Transparent		
1QV70100Z1	CRV2-90 white+Transparent	635	880-900
1QV70C00Z1	CRV2-90 bright alu+Transparent		
1QV70U00Z1	CRV2-90 satin+Transparent		
1QVA0100Z1	CRV2-100 white+Transparent	635	980-1000
1QVA0C00Z1	CRV2-100 bright alu+Transparent		
1QVA0U00Z1	CRV2-100 satin+Transparent		
1QVD0100Z1	CRV2-110 white+Transparent	710	1080-1100
1QVD0C00Z1	CRV2-110 bright alu+Transparent		
1QVD0U00Z1	CRV2-110 satin+Transparent		
1QVG0100Z1	CRV2-120 white+Transparent	710	1180-1200
1QVG0C00Z1	CRV2-120 bright alu+Transparent		
1QVG0U00Z1	CRV2-120 satin+Transparent		

Note: The entrance specified applies to a matching combination of two sizes.  
Metal bracket included.  
Product height 1950 mm.

### Finish

GLOSS SATIN WHITE

6 mm

GLASS THICKNESS

180°  
L/R OPTION

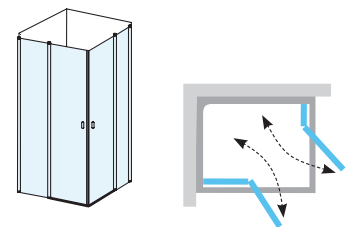

**Recommended shower trays:** Perseus Pro, Perseus Pro Flat, Perseus Pro Chrome, Gigant, Gigant Pro, Gigant Pro Flat, Gigant Pro Chrome.

### Possible combination:

A - CRV2 - choose dimensions 80 - 120 cm  
B - CRV2 - choose dimensions 80 - 120 cm

To complete your shower enclosure, it is necessary to always order at least two CRV2 products. The sum will then be the total price of the shower enclosure. The product can also be combined with CRV1 or the CPS fixed screen.

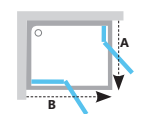

For details about frames and panels, see page 28. Other design options are available in the Custom Solution Configurator at <https://atypical.ravak.com>

The radius of the quarter-circle shower enclosures is R500.

Products are as standard delivered within 14 days.

Note: Pay attention to technical documentation before installing your shower enclosure. The number provided in the name of the product does not indicate its exact size. More at [www.ravak.com](http://www.ravak.com).

When installing a shower enclosure directly on the floor (without a shower tray), refer to the document entitled Constructional preparation found in the Customised Shower Enclosures section at [www.ravak.com](http://www.ravak.com).



GLASS PROTECTION

The glass is protected by RAVAK AntiCalc® surface treatment technology

**CPS** Fixed screen (for combining with CRV1 or CRV2)

Order No.	Type + Panel (glass)	Dimensions (mm)
9QV40100Z1	CPS-80 white+Transparent	780-800
9QV40C00Z1	CPS-80 bright alu+Transparent	
9QV40U00Z1	CPS-80 satin+Transparent	
9QV70100Z1	CPS-90 white+Transparent	880-900
9QV70C00Z1	CPS-90 bright alu+Transparent	
9QV70U00Z1	CPS-90 satin+Transparent	
9QVA0100Z1	CPS-100 white+Transparent	980-1000
9QVA0C00Z1	CPS-100 bright alu+Transparent	
9QVA0U00Z1	CPS-100 satin+Transparent	

Metal bracket included.  
Product height 1950 mm.

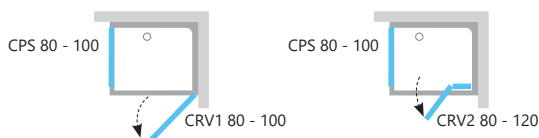
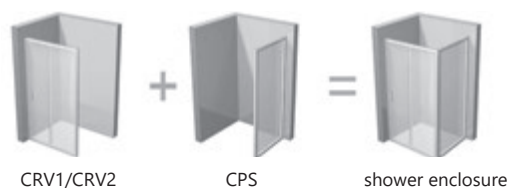

Finish

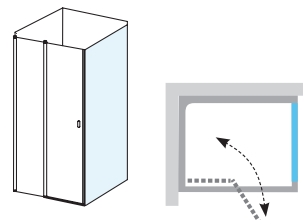

**Recommended shower trays:** Perseus Pro, Perseus Pro Flat, Perseus Pro Chrome, Gigant, Gigant Pro, Gigant Pro Flat, Gigant Pro Chrome.

**Usage possibilities:** The CPS fixed shower screen can be combined with CRV1 or CRV2 shower doors to create a rectangular or square shower space.

**CSD1** Shower doors (for niches)

Order No.	Type + Panel (glass)	Entrance (mm)	Dimensions (mm)
0QV40100Z1	CSD1-80 white+Transparent	635	775-805
0QV40C00Z1	CSD1-80 bright alu+Transparent		
0QV40U00Z1	CSD1-80 satin+Transparent		
0QV70100Z1	CSD1-90 white+Transparent	755	875-905
0QV70C00Z1	CSD1-90 bright alu+Transparent		
0QV70U00Z1	CSD1-90 satin+Transparent		

Product height 1950 mm.

Finish

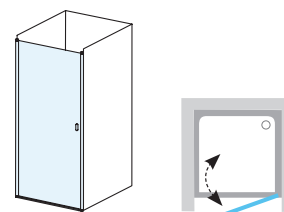

**Recommended shower trays:** Perseus Pro, Perseus Pro Flat, Perseus Pro Chrome, Gigant, Gigant Pro, Gigant Pro Flat, Gigant Pro Chrome.

**CSD2** Shower doors (for niches)

Order No.	Type + Panel (glass)	Entrance (mm)	Dimensions (mm)
0QVAC100Z1	CSD2-100 white+Transparent	655	975-1005
0QVACC00Z1	CSD2-100 bright alu+Transparent		
0QVACU00Z1	CSD2-100 satin+Transparent		
0QVDC100Z1	CSD2-110 white+Transparent	655	1075-1105
0QVDCC00Z1	CSD2-110 bright alu+Transparent		
0QVDCU00Z1	CSD2-110 satin+Transparent		
0QVGC100Z1	CSD2-120 white+Transparent	655	1175-1205
0QVGCC00Z1	CSD2-120 bright alu+Transparent		
0QVGCU00Z1	CSD2-120 satin+Transparent		

Metal bracket included.  
Product height 1950 mm.

Finish

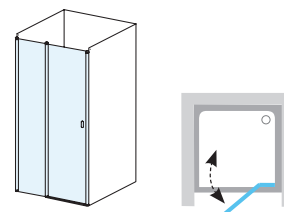

**Recommended shower trays:** Perseus Pro, Perseus Pro Chrome, Gigant, Gigant Pro, Gigant Pro Flat, Gigant Pro Chrome.

For details about frames and panels, see page 28. Other design options are available in the Custom Solution Configurator at <https://atypical.ravak.com>

The CSD1, CSD2, and CSDL2 shower doors cannot be combined with the CPS fixed wall.

Products are as standard delivered within 14 days.

Note: Pay attention to technical documentation before installing your shower enclosure. The number provided in the name of the product does not indicate its exact size. More at [www.ravak.com](http://www.ravak.com).

When installing a shower enclosure directly on the floor (without a shower tray), refer to the document entitled Constructional preparation found in the Customised Shower Enclosures section at [www.ravak.com](http://www.ravak.com).



5

NOW 5 YEAR WARRANTY FOR ALL SHOWER ENCLOSURES AND DOORS



CONCEPTS  
Items in perfect harmony



RISE MECHANISM  
Enables the door to be lifted and locked in the main position

## CSDL2 Shower doors (for niches)

Order No.	Type + Panel (glass)	Entrance (mm)	Dimensions (mm)
0QV7C10LZ1	CSDL2-90 white+glass Transparent	720	875-905
0QV7CU0LZ1	CSDL2-90 satin+glass Transparent		
0QV7CC0LZ1	CSDL2-90 bright alu+glass Transparent		
0QVAC10LZ1	CSDL2-100 white+glass Transparent	820	975-1005
0QVACU0LZ1	CSDL2-100 satin+glass Transparent		
0QVACC0LZ1	CSDL2-100 bright alu+glass Transparent		
0QVDC10LZ1	CSDL2-110 white+glass Transparent	920	1075-1105
0QVDCU0LZ1	CSDL2-110 satin +Transparent		
0QVDC0LZ1	CSDL2-110 bright alu+glass Transparent		
0QVGC10LZ1	CSDL2-120 white+Transparent	1020	1175-1205
0QVGCU0LZ1	CSDL2-120 satin+Transparent		
0QVGC0LZ1	CSDL2-120 bright alu+Transparent		

Product height 1950 mm.

Finish

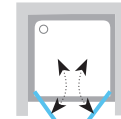
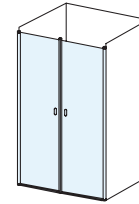

**Recommended shower trays:** Perseus Pro, Perseus Pro Flat, Perseus Pro Chrome, Gigant Pro, Gigant Pro Flat, Gigant Pro Chrome.

## CNPS

Order No.	Type + Panel (glass)
E778801C19470	Aluminium profile CNPS bright alu
E778801119470	Aluminium profile CNPS white
E778801U19470	Aluminium profile CNPS satin
E778801C19400	Aluminium profile CNPS for CPS bright alu
E778801119400	Aluminium profile CNPS for CPS white
E778801U19400	Aluminium profile CNPS for CPS satin

Product height 1950 mm.

Finish



## Fixing profiles Chrome

new

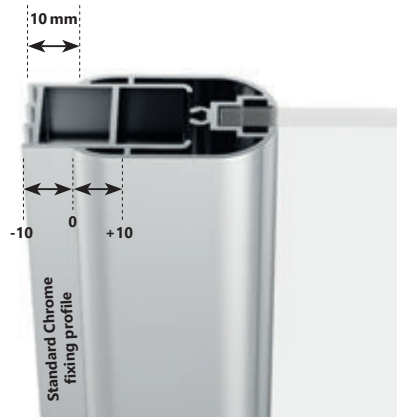

A standard fixing profile is a part of every Chrome product package and allows adjusting (expanding/narrowing) the product by 10 mm.

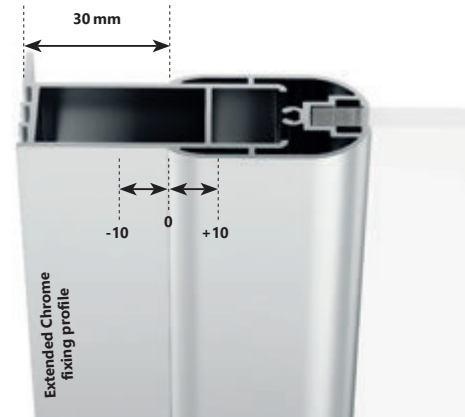

If you need to expand the product more than that, it is necessary to buy a new, extended fixing profile, which is 20 mm wider and allows extending the product by an extra 20 mm, while retaining the +/- 10 mm adjustability.



Extended fixing profile

For details about frames and panels, see page 28. Other design options are available in the Custom Solution Configurator at <https://atypical.ravak.com>  
The CSD1, CSD2, and CSDL2 shower doors cannot be combined with the CPS fixed wall.

Products are as standard delivered within 14 days.

Note: Pay attention to technical documentation before installing your shower enclosure. The number provided in the name of the product does not indicate its exact size. More at [www.ravak.com](http://www.ravak.com).

When installing a shower enclosure directly on the floor (without a shower tray), refer to the document entitled Constructional preparation found in the Customised Shower Enclosures section at [www.ravak.com](http://www.ravak.com).





Design Kryštof Nosál







# Pivot

Touching the future



## Ingeniously simple opening

The high-alloy steel pivot embedded in a high-quality housing leaves no room for complications.



## Clean design

Minimum of metal profiles and maximum of safety glass.

## Quadrant shower enclosures



### **PSKK3 - Three-part quadrant shower enclosure**

Maximum design at minimum price. Impressive and keenly priced shower enclosure featuring elegant clear glass panels and subtle metal profiles.

**Ergonomic holder in three ways - turned downwards or sideways, it enables you to open the door comfortably while, if turned upwards, it becomes a very practical towel-hanger.**



## Corner shower enclosures



### **PDOP2 + PPS - shower door + fixed wall, with front entry**

A shower enclosure tailored to your needs. Combine the shower door with fixed wall to create a showering space in dimensions from 80 x 80 cm up to 120 x 100 cm.

**Pivot mechanism - a solution which will last for generations. Ingeniously simple opening of the door using a pivot of high-alloy steel attached in a quality housing. Door opening which leaves no room for problems.**







**PDOP1 - Single-part pivot turning shower door**

Tailored to your wishes. Use the extension profiles (PNPS) to widen this product (and all products of this range as well) by 4 cm on each side.

**A shower enclosure with white frame comes in two options: with white or chromium-plated hinges and holders. A shower enclosure with satin frame features hinges and handles in satin finish. These components are chrome-plated in the case of glossy frame.**

**PDOP2 - Two-part pivot turning shower door**

Even wider. Two-part shower door in widths of 100, 110 and 120 cm.

► Design on p. 86-87





## Quadrant shower enclosures

## Corner shower enclosures



**PSKK3 black** - Three-part quadrant shower enclosure



**PDOP2 black + PPS black**  
- shower door + fixed wall, with front entry

**PDOP1 black** - Single-part pivot turning shower door

The Black variant includes a frame, handle and hinges in black colour. They are in great contrast with the safety glass surfaces, decently attracting attention.



Enjoy comfortable showering while sitting on a design seat. It will be great for relaxation and you will appreciate it while taking care of your feet.

► Seats see p. 128



**PDOP2 black** - Two-part pivot turning shower door

► Design on p. 86-87

# Pivot

**5** NOW 5 YEAR WARRANTY FOR ALL SHOWER ENCLOSURES AND DOORS

**L/R OPTION**  
Right/left option by flipping the product by 180 degrees

**EASY MAINTENANCE**  
Minimum profiles and no unreachable spots

## PSKK3 Shower enclosure

Order No.	Type + Panel (glass)	Entrance (mm)	Dimensions (mm)
37644100Z1	PSKK3-80 white+glass Transparent	490	770-795x770-795
37644101Z1	PSKK3-80 white/white+glass Transparent		
37644C00Z1	PSKK3-80 bright alu+glass Transparent		
37644U00Z1	PSKK3-80 satin+glass Transparent		
37644300Z1	PSKK3-80 black+glass Transparent	490	870-895x870-895
37677100Z1	PSKK3-90 white+glass Transparent		
37677101Z1	PSKK3-90 white/white+glass Transparent		
37677C00Z1	PSKK3-90 bright alu+glass Transparent		
37677U00Z1	PSKK3-90 satin+glass Transparent	490	970-995x970-995
37677300Z1	PSKK3-90 black+glass Transparent		
376AA100Z1	■ PSKK3-100 white+glass Transparent		
376AA101Z1	■ PSKK3-100 white/white+glass Transparent		
376AAC00Z1	■ PSKK3-100 bright alu+glass Transparent	490	970-995x970-995
376AAU00Z1	■ PSKK3-100 satin+glass Transparent		
376AA300Z1	■ PSKK3-100 black+glass Transparent		

Product height 1900 mm.

■ 6 week delivery time.

### Finish

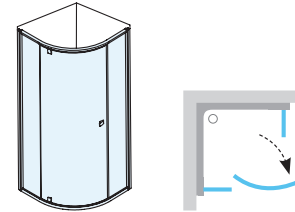
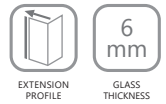

**Recommended shower trays:** Elipso, Elipso Pro, Elipso Pro Flat, Elipso Pro Chrome.

## PDOP1 Shower doors (for niches or in combination with PPS)

Order No.	Type + Panel (glass)	Entrance (mm)	Dimensions (mm)
03G40100Z1	PDOP1-80 white+glass Transparent	492	761-811
03G40101Z1	PDOP1-80 white/white+ Transparent		
03G40C00Z1	PDOP1-80 bright alu+glass Transparent		
03G40U00Z1	PDOP1-80 satin+glass Transparent		
03G40300Z1	PDOP1-80 black+glass Transparent	592	861-911
03G70100Z1	PDOP1-90 white+glass Transparent		
03G70101Z1	PDOP1-90 white/white+Transparent		
03G70C00Z1	PDOP1-90 bright alu+glass Transparent		
03G70U00Z1	PDOP1-90 satin+glass Transparent	592	1161-1211
03G70300Z1	PDOP1-90 black+glass Transparent		

Product height 1900 mm.

### Finish

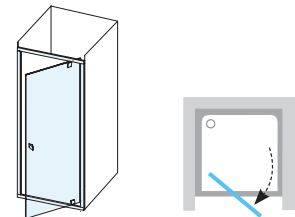
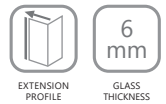

**Recommended shower trays:** Aneta, Perseus, Perseus Pro, Perseus Pro Flat, Perseus Pro Chrome, Gigant, Gigant Pro, Gigant Pro Flat, Gigant Pro Chrome.

## PDOP2 Shower doors (for niches or in combination with PPS)

Order No.	Type + Panel (glass)	Entrance (mm)	Dimensions (mm)
03GA0100Z1	PDOP2-100 white+glass Transparent	492	961-1011
03GA0101Z1	PDOP2-100 white/white+Transparent		
03GA0C00Z1	PDOP2-100 bright alu+glass Transparent		
03GA0U00Z1	PDOP2-100 satin+glass Transparent		
03GA0300Z1	PDOP2-100 black+glass Transparent	592	1061-1111
03GD0100Z1	■ PDOP2-110 white+glass Transparent		
03GD0101Z1	■ PDOP2-110 white/white+Transparent		
03GD0C00Z1	■ PDOP2-110 bright alu+glass Transparent		
03GD0U00Z1	■ PDOP2-110 satin+glass Transparent	592	1161-1211
03GD0300Z1	■ PDOP2-110 black+glass Transparent		
03GG0100Z1	■ PDOP2-120 white+glass Transparent		
03GG0101Z1	■ PDOP2-120 white/white+Transparent		
03GG0C00Z1	■ PDOP2-120 bright alu+glass Transparent	592	1161-1211
03GG0U00Z1	■ PDOP2-120 satin+glass Transparent		
03GG0300Z1	■ PDOP2-120 black+glass Transparent		

Product height 1900 mm.

■ 6 week delivery time.

### Finish

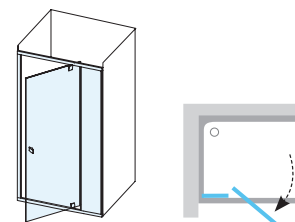
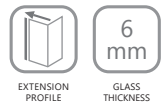

**Recommended shower trays:** Perseus, Perseus Pro, Perseus Pro Flat, Perseus Pro Chrome, Gigant, Gigant Pro, Gigant Pro Flat, Gigant Pro Chrome.

For details about frames and panels, see page 28. Other design options are available in the Custom Solution Configurator at <https://atypical.ravak.com>

The radius of the quarter-circle shower enclosures is R500.

Products are as standard delivered within 14 days.

Note: Pay attention to technical documentation before installing your shower enclosure. The number provided in the name of the product does not indicate its exact size. More at [www.ravak.com](http://www.ravak.com).

When installing a shower enclosure directly on the floor (without a shower tray), refer to the document entitled Constructional preparation found in the Customised Shower Enclosures section at [www.ravak.com](http://www.ravak.com).





GLASS PROTECTION

The glass is protected by RAVAK AntiCalc® surface treatment technology

**PPS** Fixed screen (for combining with PDOP1 or PDOP2)

Order No.	Type + Panel (glass)	Dimensions (mm)
90G40100Z1	PPS-80 white+glass Transparent	770-795
90G40C00Z1	PPS-80 bright alu+glass Transparent	
90G40U00Z1	PPS-80 satin+glass Transparent	
90G40300Z1	PPS-80 black+glass Transparent	
90G70100Z1	PPS-90 white+glass Transparent	870-895
90G70C00Z1	PPS-90 bright alu+glass Transparent	
90G70U00Z1	PPS-90 satin+glass Transparent	
90G70300Z1	PPS-90 black+glass Transparent	
90GA0100Z1	PPS-100 white+glass Transparent	970-995
90GA0C00Z1	PPS-100 bright alu+glass Transparent	
90GA0U00Z1	PPS-100 satin+glass Transparent	
90GA0300Z1	PPS-100 black+glass Transparent	

Product height 1900 mm.

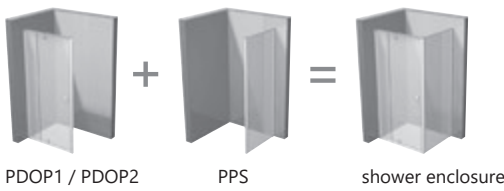

Finish

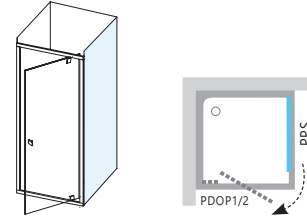
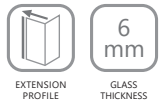

**Recommended shower trays:** Perseus Pro, Perseus Pro Flat, Perseus Pro Chrome, Gigant, Gigant Pro, Gigant Pro Flat, Gigant Pro Chrome.

**Usage possibilities:** By combining the PPS fixed shower screen and a shower door of choice (PDOP1 or PDOP2), you can create a square or rectangular shower enclosure of various dimensions.

**PNPS** Extension profile

Order No.	Type	Height (mm)
E778801119000	Extension profile PNPS white	1900
E778801319000	Extension profile PNPS black	
E778801U19000	Extension profile PNPS satin	

Pivot shower enclosures in glossy design can be expanded using the BLNPS extension profile, see p. 109.

Finish

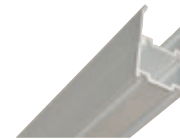

Extension profiles PNPS make it possible to extend the shower enclosure or door by 2 cm on each side.

**Fixing profiles and extension profiles**

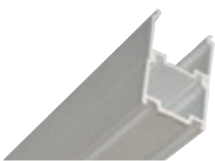

**Extension profiles**  
Make it possible to extend the shower enclosure or door by 2 cm on each side.  
**Extension profiles are available for the following ranges: Pivot, 10°, Blix, and Supernova.**



**Extension profile, also in black option, for the Pivot line.**

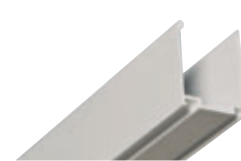

**Fixing profile**  
Used for mounting the shower enclosure or door to the wall.  
**Not sold separately, this profile is included as standard with any product where necessary.**

For details about frames and panels, see page 28. Other design options are available in the Custom Solution Configurator at <https://atypical.ravak.com>

Products are as standard delivered within 14 days.

Note: Pay attention to technical documentation before installing your shower enclosure. The number provided in the name of the product does not indicate its exact size. More at [www.ravak.com](http://www.ravak.com).

When installing a shower enclosure directly on the floor (without a shower tray), refer to the document entitled Constructional preparation found in the Customised Shower Enclosures section at [www.ravak.com](http://www.ravak.com).

Now in black







# Blix Slim

Modern slimness



## Slim frame

The fine proportions of the frame give the shower enclosure a new flair while not burdening the bathroom optically.



## Efficient sliding system

Sliding door saves space by not interfering with the bathroom space. Residual water does not drip to the floor where it could increase the risk of slipping.



## Quadrant shower enclosures



### **BLSCP4** - Four-part quadrant sliding shower enclosure

Space-saving and budget-wise. The shower enclosure features a glass panel with a reliable slider.

## Corner shower enclosures



### **BLSRV2** - Four-part corner entry sliding shower enclosure

A square-shaped shower enclosure with a spacious corner entrance without a possibility of combining the dimensions.



### **BLSRV2K+BLSRV2K** - Four-part corner entry sliding shower enclosure

By combining different sizes of BLSRV2K, you can create a square or rectangular shower enclosure with a central entrance.

## Shower Door

**BLSDP2 - Two-part sliding shower door**

Tailored to your wishes. Turning the product round will give you the left or right hand side option.

When mounting a shower enclosure directly onto the floor, use a floor drain or a shower channel.

► see p. 156



The design of this product is not disrupted by any vertical inner profiles. It is made of clear safety glass with a thickness of 6 mm hung in aluminium fixing profiles.

**BLSDP2 + BLSPS - shower door + fixed wall, with front entry**

A corner shower enclosure tailored to your wish. Combine the shower door with the fixed wall to create a showering space in dimensions from 100 x 80 cm up to 120 x 90 cm.

► Design on p. 94-95





new

## Quadrant shower enclosures



### **BLSCP4 black** - Four-part quadrant sliding shower enclosure

Space-saving and budget-wise. The shower enclosure features a glass panel with a reliable slider.

## Corner shower enclosures



### **BLSRV2 black** - Four-part corner entry sliding shower enclosure

A square-shaped shower enclosure with a spacious corner entrance without a possibility of combining the dimensions.

### **BLSRV2K black** + **BLSRV2K black** - Four-part corner entry sliding shower enclosure

By combining different sizes of BLSRV2K, you can create a square or rectangular shower enclosure with a central entrance.





## Shower Door

**BLSDP2 black** - Two-part sliding shower door

Tailored to your wishes.  
Turning the product round will give you the left or right hand side option.



Enjoy comfortable showering while sitting on a design seat. It will be great for relaxation and you will appreciate it while taking care of your feet.

► Seats see p. 132

**BLSDP2 black**  
+ **BLSPS black** - shower door + fixed wall, with front entry

A corner shower enclosure tailored to your wish. Combine the shower door with the fixed wall to create a showering space in dimensions from 100 x 80 cm up to 120 x 90 cm.

► Design on p. 94-95



# Blix Slim

**5** NOW 5 YEAR WARRANTY FOR ALL SHOWER ENCLOSURES AND DOORS

**EASY INSTALLATION**  
Frame installation requires only a few screws

**GLASS PROTECTION**  
The glass is protected by RAVAK AntiCalc® surface treatment technology

## BLSCP4 Shower enclosure

Order No.	Type + Panel (glass)	Entrance (mm)	Dimensions (mm)
X3BM40C00Z1	BLSCP4-80 bright alu+Transparent	485	786-800x786-800
X3BM40300Z1	BLSCP4-80 black+glass Transparent		
X3BM70C00Z1	BLSCP4-90 bright alu+Transparent	485	886-900x886-900
X3BM70300Z1	BLSCP4-90 black+glass Transparent		

Product height 1950 mm.

Finish

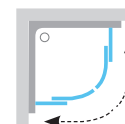
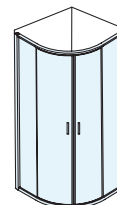

**Recommended shower trays:** Ronda, Elipso, Elipso Pro, Elipso Pro Flat, Elipso Pro Chrome.

## BLSRV2 Shower enclosure

Order No.	Type + Panel (glass)	Entrance (mm)	Dimensions (mm)
X1LM40C00Z1	BLSRV2-80 bright alu+Transparent	410	786-800x786-800
X1LM40300Z1	BLSRV2-80 black+glass Transparent		
X1LM70C00Z1	BLSRV2-90 bright alu+Transparent	480	886-900x886-900
X1LM70300Z1	BLSRV2-90 black+glass Transparent		

Product height 1950 mm.

Finish

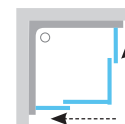
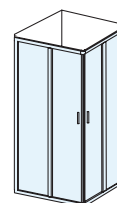

**Recommended shower trays:** Angela, Perseus, Perseus Pro, Perseus Pro Flat, Perseus Pro Chrome.

## BLSRV2K + BLSRV2K Shower enclosure

Order No.	Type + Panel (glass)	Dimensions (mm)
X1XM40C00Z1	BLSRV2K-80 bright alu+glass Transparent	786-800
X1XM40300Z1	BLSRV2K-80 black+glass Transparent	
X1XM70C00Z1	BLSRV2K-90 bright alu+glass Transparent	886-900
X1XM70300Z1	BLSRV2K-90 black+glass Transparent	
X1XMA0C00Z1	BLSRV2K-100 bright alu+glass Transparent	986-1000
X1XMA0300Z1	BLSRV2K-100 black+glass Transparent	
X1XMG0C00Z1	BLSRV2K-120 bright alu+glass Transparent	1186-1200
X1XMG0300Z1	BLSRV2K-120 black+glass Transparent	

Note: The entrance specified applies to a matching combination of two sizes.

Product height 1950 mm.

Finish

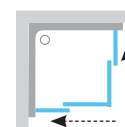
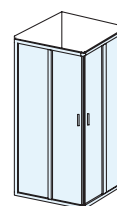

**Recommended shower trays:** Angela, Perseus, Perseus Pro, Perseus Pro Flat, Perseus Pro Chrome, Gigant, Gigant Pro, Gigant Pro Flat, Gigant Pro Chrome.

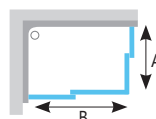

**Possible combination:**

A – BLRV2K – custom size 80 – 120 cm,  
B – BLRV2K – custom size 80 – 120 cm.  
(For more comfortable showering, choose for example 80 x 120 cm).

For the completion of the shower enclosure, at least 2 items of the product must be ordered. This will create the total price of the shower enclosure. The product cannot be used separately as a shower door or in combination with a fixed screen!

For details about frames and panels, see page 28. Other design options are available in the Custom Solution Configurator at <https://atypical.ravak.com>

The radius of the quarter-circle shower enclosures is R500.

Products are as standard delivered within 14 days.

Note: Pay attention to technical documentation before installing your shower enclosure. The number provided in the name of the product does not indicate its exact size. More at [www.ravak.com](http://www.ravak.com).

When installing a shower enclosure directly on the floor (without a shower tray), refer to the document entitled Constructional preparation found in the Customised Shower Enclosures section at [www.ravak.com](http://www.ravak.com).

**BLSDP2** Shower doors (for niches or in combination with a fixed screen)

Order No.	Type + Panel (glass)	Entrance (mm)	Dimensions in niche (mm)	Dimensions with BLSPS (mm)
X0PMA0C00Z1	BLSDP2-100 bright alu+Transparent	400	977-1005	990-1018
X0PMA0300Z1	BLSDP2-100 black+glass Transparent			
X0PMD0C00Z1	BLSDP2-110 bright alu+ glass Transparent	450	1077-1105	1090-1118
X0PMD0300Z1	BLSDP2-110 black+glass Transparent			
X0PMG0C00Z1	BLSDP2-120 bright alu+Transparent	500	1177-1205	1190-1218
X0PMG0300Z1	BLSDP2-120 black+glass Transparent			

Product height 1950 mm.

Finish

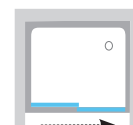
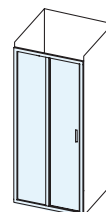

**Recommended shower trays:** Perseus, Perseus Pro, Perseus Pro Chrome, Gigant, Gigant Pro, Gigant Pro Flat, Gigant Pro Chrome.

**BLSPS** Fixed screen (for combining with BLSDP2)

Order No.	Type + Panel (glass)	Dimensions (mm)
X9BM40C00Z1	BLSPS-80 bright alu+Transparent	785-800
X9BM40300Z1	BLSPS-80 black+glass Transparent	
X9BM70C00Z1	BLSPS-90 bright alu+Transparent	885-900
X9BM70300Z1	BLSPS-90 black+glass Transparent	

Product height 1950 mm.

Finish

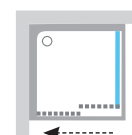
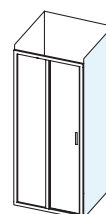

**Recommended shower trays:** Perseus, Perseus Pro, Perseus Pro Flat, Perseus Pro Chrome, Gigant, Gigant Pro, Gigant Pro Flat, Gigant Pro Chrome.

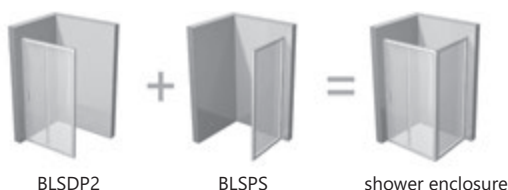

BLSDP2 + BLSPS

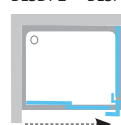

**Usage possibilities:** By joining the BLSPS fixed wall and the selected size of the BLSDP2 shower door, you will get a rectangular shower enclosure of different sizes.







# Blix

Practical and  
attractive



## Efficient sliding system

Sliding door saves space by not interfering with the bathroom space. Residual water does not drip to the floor where it could increase the risk of slipping.



## Easy cleaning

The door wing tilt system will allow you to reach difficult areas very easily.



# Quadrant shower enclosures



## **BLCP4 - Four-part quadrant sliding shower enclosure**

Space-saving and budget-wise. The shower enclosure features a glass panel with a reliable slider.

**Do your children love taking baths? They can enjoy daily bathing even in a small bathroom thanks to the deep seating shower tray.**

► see p. 146

## **BLCP4 Sabina - Four-part quadrant sliding shower enclosure with a reduced height**

A 'short' variant of the previous model. The shower enclosure is designed for combination with the Sabina deep seating shower tray. It combines the advantages of baths and shower enclosures.





# Corner shower enclosures

## **BLRV2** - Four-part corner entry sliding shower enclosure

A square-shaped shower enclosure with a spacious corner entrance without a possibility of combining the dimensions.

**Durable frame construction combines with modern design. Together it creates a long-lasting product.**



## **BLRV2K + BLRV2K** - Four-part corner entry sliding shower enclosure

To obtain a square-shaped or a rectangular-shaped shower enclosure with central entry, combine different dimensions of the BLRV2K product.



► Design on p. 104-109

# Shower Door



## **BLDP2 - Two-part sliding shower door**

Tailored to your wishes. Use the extension profiles (BLNPS) to extend this product by up to 4 cm on each side. Turning the product round will give you the left or right hand side option.



Complement your new shower enclosure with a RAVAK thermostatic faucet to maintain constant water temperature; see p. 390.



The glossy aluminium handle has an ergonomic design for comfortable and easy door opening.

## **BLDP4 - Four-part sliding shower door**

The widest central entry shower door on the market. Combine it with the BLPS fixed wall to create a showering space in dimensions up to 100 x 200 cm.

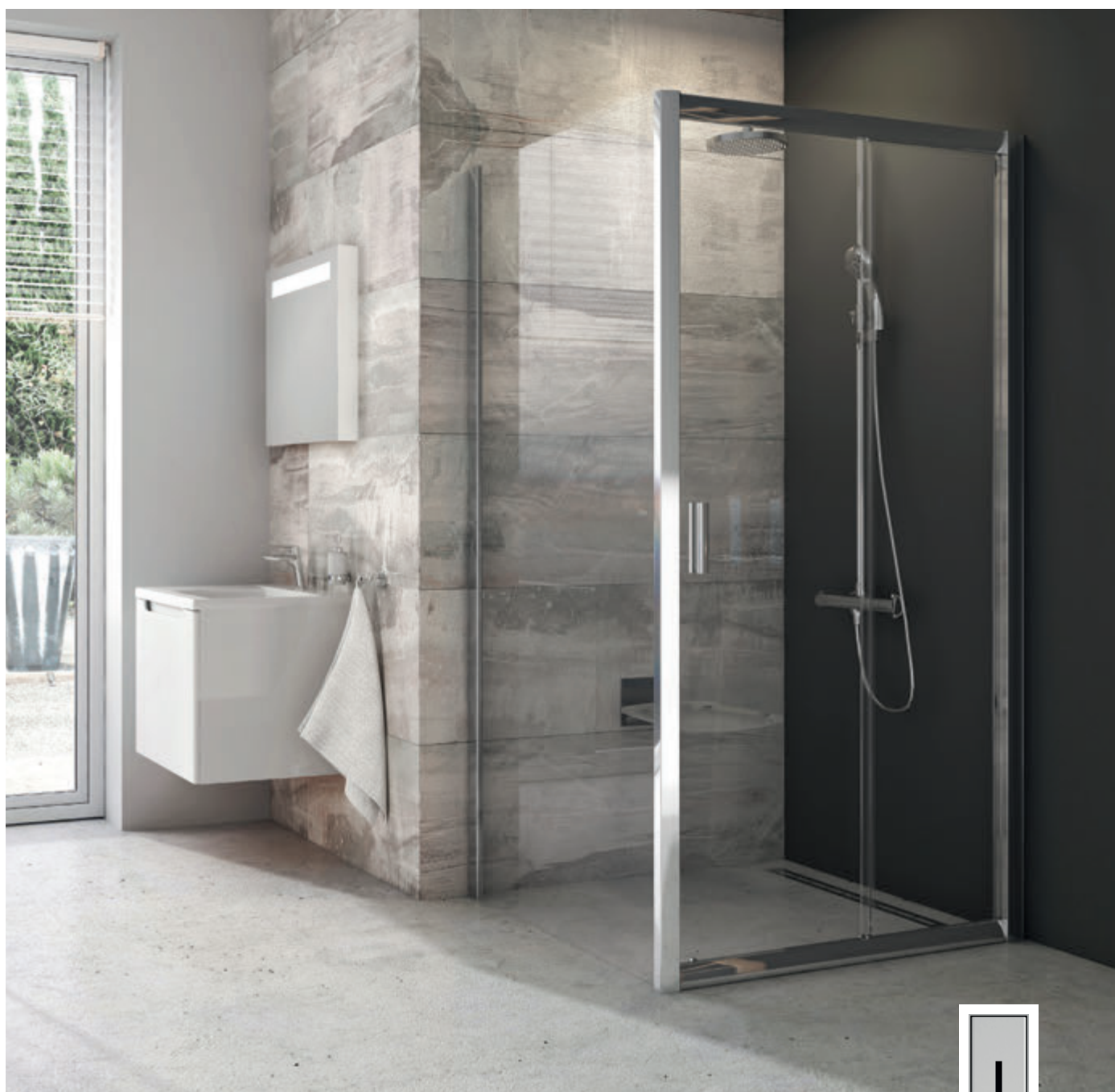

**BLDP2 + BLPS** - shower door + fixed wall, with front entry

A corner shower enclosure tailored to your wish. Combine the shower door with fixed wall to create a showering space in dimensions from 100 x 80 cm up to 120 x 100 cm.

The Runway shower channel will provide undisturbed floor design.

► see p. 157



# Shower Door



## **BLDZ2 - Two-part folding shower door**

Suitable for the smallest spaces. The folding door of modern look enables the maximum entrance width.

Handle adapted particularly to folding or sliding door on which you will appreciate the solid and comfortable grip.





**BLDZ2 + BLPSZ - shower door + fixed wall,  
with front entry**

You can create a customised showering space by combining a folding door and fixed wall. The fixed wall can only be combined with the BLDZ2 folding door.

**5** NOW 5 YEAR WARRANTY FOR ALL SHOWER ENCLOSURES AND DOORS

**EASY INSTALLATION**  
Frame installation requires only a few screws

**GLASS PROTECTION**  
The glass is protected by RAVAK AntiCalc® surface treatment technology

## BLCP4 Shower enclosure

Order No.	Type + Panel (glass)	Entrance (mm)	Dimensions (mm)
3B240100Z1	BLCP4-80 white+glass Transparent	490	780-800x780-800
3B240100ZG	BLCP4-80 white+glass Grape		
3B240C00Z1	BLCP4-80 bright alu+glass Transparent		
3B240C00ZG	BLCP4-80 bright alu+glass Grape		
3B240U00Z1	BLCP4-80 satin+glass Transparent		
3B240U00ZG	BLCP4-80 satin+glass Grape		
3B270100Z1	BLCP4-90 white +glass Transparent	565	880-900x880-900
3B270100ZG	BLCP4-90 white+glass Grape		
3B270C00Z1	BLCP4-90 bright alu+glass Transparent		
3B270C00ZG	BLCP4-90 bright alu+glass Grape		
3B270U00Z1	BLCP4-90 satin +glass Transparent		
3B270U00ZG	BLCP4-90 satin+glass Grape		

Product height 1900 mm.

### Finish

GLOSS SATIN WHITE

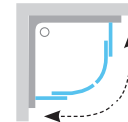
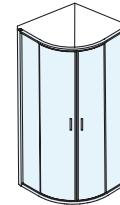

**Recommended shower trays:** Ronda, Elipso, Elipso Pro, Elipso Pro Flat, Elipso Pro Chrome.

## BLCP4 Sabina Shower enclosure

Order No.	Type + Panel (glass)	Entrance (mm)	Dimensions (mm)
3B240140Z1	BLCP4-80 SABINA white+glass Transparent	490	780-800x780-800
3B240140ZG	BLCP4-80 SABINA white+glass Grape		
3B240C40Z1	BLCP4-80 SABINA bright alu+glass Transparent		
3B240C40ZG	BLCP4-80 SABINA bright alu+glass Grape		
3B240U40Z1	BLCP4-80 SABINA satin+glass Transparent		
3B240U40ZG	BLCP4-80 SABINA satin+glass Grape		
3B270140Z1	BLCP4-90 SABINA white+glass Transparent	565	880-900x880-900
3B270140ZG	BLCP4-90 SABINA white+glass Grape		
3B270C40Z1	BLCP4-90 SABINA bright alu+glass Transparent		
3B270C40ZG	BLCP4-90 SABINA bright alu+glass Grape		
3B270U40Z1	BLCP4-90 SABINA satin+glass Transparent		
3B270U40ZG	BLCP4-90 SABINA satin+glass Grape		

Product height 1750 mm.

### Finish

GLOSS SATIN WHITE

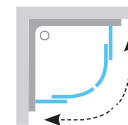
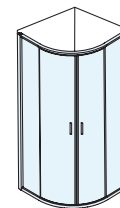

**Recommended shower trays:** Sabina.

## BLRV2 Shower enclosure

Order No.	Type + Panel (glass)	Entrance (mm)	Dimensions (mm)
1LV40100Z1	BLRV2-80 white+glass Transparent	435	780-800x780-800
1LV40100ZG	BLRV2-80 white+glass Grape		
1LV40C00Z1	BLRV2-80 bright alu+glass Transparent		
1LV40C00ZG	BLRV2-80 bright alu+glass Grape		
1LV40U00Z1	BLRV2-80 satin+glass Transparent		
1LV40U00ZG	BLRV2-80 satin+glass Grape		
1LV70100Z1	BLRV2-90 white+glass Transparent	500	880-900x880-900
1LV70100ZG	BLRV2-90 white+glass Grape		
1LV70C00Z1	BLRV2-90 bright alu+glass Transparent		
1LV70C00ZG	BLRV2-90 bright alu+glass Grape		
1LV70U00Z1	BLRV2-90 satin+glass Transparent		
1LV70U00ZG	BLRV2-90 satin+glass Grape		

Product height 1900 mm.

### Finish

GLOSS SATIN WHITE

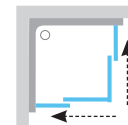
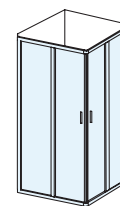

**Recommended shower trays:** Angela, Perseus, Perseus Pro, Perseus Pro Flat, Perseus Pro Chrome.

For details about frames and panels, see page 28. Other design options are available in the Custom Solution Configurator at <https://atypical.ravak.com>

The radius of the quarter-circle shower enclosures is R500.

Products are as standard delivered within 14 days.

Note: Pay attention to technical documentation before installing your shower enclosure. The number provided in the name of the product does not indicate its exact size. More at [www.ravak.com](http://www.ravak.com).

When installing a shower enclosure directly on the floor (without a shower tray), refer to the document entitled Constructional preparation found in the Customised Shower Enclosures section at [www.ravak.com](http://www.ravak.com).





**SILENT OPERATION**  
Silent operation of your shower enclosure enclosure

**BLRV2K + BLRV2K Shower enclosure**

Order No.	Type + Panel (glass)	Entrance (mm)	Dimensions (mm)
1XV40100Z1	BLRV2K-80 white+glass Transparent	435	780-800
1XV40100ZG	BLRV2K-80 white+glass Grape		
1XV40C00Z1	BLRV2K-80 bright alu+glass Transparent		
1XV40C00ZG	BLRV2K-80 bright alu+glass Grape		
1XV40U00Z1	BLRV2K-80 satin+glass Transparent		
1XV40U00ZG	BLRV2K-80 satin+glass Grape		
1XV70100Z1	BLRV2K-90 white+glass Transparent	500	880-900
1XV70100ZG	BLRV2K-90 white+glass Grape		
1XV70C00Z1	BLRV2K-90 bright alu+glass Transparent		
1XV70C00ZG	BLRV2K-90 bright alu+glass Grape		
1XV70U00Z1	BLRV2K-90 satin+glass Transparent		
1XV70U00ZG	BLRV2K-90 satin+glass Grape		
1XVA0100Z1	BLRV2K-100 white+glass Transparent	575	980-1000
1XVA0100ZG	BLRV2K-100 white+glass Grape		
1XVA0C00Z1	BLRV2K-100 bright alu+glass Transparent		
1XVA0C00ZG	BLRV2K-100 bright alu+glass Grape		
1XVA0U00Z1	BLRV2K-100 satin+glass Transparent		
1XVA0U00ZG	BLRV2K-100 satin+glass Grape		
1XVD0100Z1	BLRV2K-110 white+glass Transparent	575	1080-1100
1XVD0100ZG	BLRV2K-110 white+glass Grape		
1XVD0C00Z1	BLRV2K-110 bright alu+glass Transparent		
1XVD0C00ZG	BLRV2K-110 bright alu+glass Grape		
1XVD0U00Z1	BLRV2K-110 satin+glass Transparent		
1XVD0U00ZG	BLRV2K-110 satin+glass Grape		
1XVG0100Z1	BLRV2K-120 white+glass Transparent	575	1180-1200
1XVG0100ZG	BLRV2K-120 white+glass Grape		
1XVG0C00Z1	BLRV2K-120 bright alu+glass Transparent		
1XVG0C00ZG	BLRV2K-120 bright alu+glass Grape		
1XVG0U00Z1	BLRV2K-120 satin+glass Transparent		
1XVG0U00ZG	BLRV2K-120 satin+glass Grape		

Note: The entrance specified applies to a matching combination of two sizes.  
Product height 1900 mm.

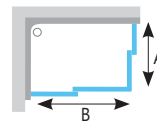

**Finish**

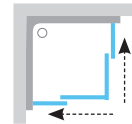
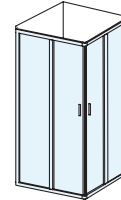

**Recommended shower trays:** Angela, Perseus, Perseus Pro, Perseus Pro Flat, Perseus Pro Chrome, Gigant, Gigant Pro, Gigant Pro Flat, Gigant Pro Chrome.

**Possible combination:**

A – BLRV2K – custom size 80 – 120 cm,  
B – BLRV2K – custom size 80 – 120 cm.  
(For more comfortable showering, choose for example 80 x 120 cm).

For the completion of the shower enclosure, at least 2 items of the product must be ordered. This will create the total price of the shower enclosure. The product cannot be used separately as a shower door or in combination with a fixed screen!

**BLDP2 Shower doors (for niches or in combination with BLPS)**

Order No.	Type + Panel (glass)	Entrance (mm)	Dimensions (mm)
0PVA0100Z1	BLDP2-100 white+glass Transparent	410	970-1010
0PVA0100ZG	BLDP2-100 white+glass Grape		
0PVA0C00Z1	BLDP2-100 bright alu+glass Transparent		
0PVA0C00ZG	BLDP2-100 bright alu+glass Grape		
0PVA0U00Z1	BLDP2-100 satin+glass Transparent		
0PVA0U00ZG	BLDP2-100 satin+glass Grape		
0PVD0100Z1	BLDP2-110 white+glass Transparent	460	1070-1110
0PVD0100ZG	BLDP2-110 white+glass Grape		
0PVD0C00Z1	BLDP2-110 bright alu+glass Transparent		
0PVD0C00ZG	BLDP2-110 bright alu+glass Grape		
0PVD0U00Z1	BLDP2-110 satin+glass Transparent		
0PVD0U00ZG	BLDP2-110 satin+glass Grape		
0PVG0100Z1	BLDP2-120 white+glass Transparent	510	1170-1210
0PVG0100ZG	BLDP2-120 white+glass Grape		
0PVG0C00Z1	BLDP2-120 bright alu+glass Transparent		
0PVG0C00ZG	BLDP2-120 bright alu+glass Grape		
0PVG0U00Z1	BLDP2-120 satin+glass Transparent		
0PVG0U00ZG	BLDP2-120 satin+glass Grape		

Product height 1900 mm.

**Finish**

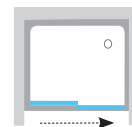
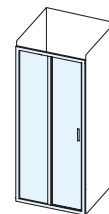

**Recommended shower trays:** Perseus, Perseus Pro, Perseus Pro Chrome, Gigant, Gigant Pro, Gigant Pro Flat, Gigant Pro Chrome.

For details about frames and panels, see page 28. Other design options are available in the Custom Solution Configurator at <https://atypical.ravak.com>

Products are as standard delivered within 14 days.

Note: Pay attention to technical documentation before installing your shower enclosure. The number provided in the name of the product does not indicate its exact size. More at [www.ravak.com](http://www.ravak.com).

When installing a shower enclosure directly on the floor (without a shower tray), refer to the document entitled Constructional preparation found in the Customised Shower Enclosures section at [www.ravak.com](http://www.ravak.com).

5

NOW 5 YEAR WARRANTY FOR ALL SHOWER ENCLOSURES AND DOORS



EASY INSTALLATION  
Frame installation requires only a few screws



GLASS PROTECTION  
The glass is protected by RAVAK AntiCalc® surface treatment technology

## BLDP4 Shower doors (for niches or in combination with BLPS)

Order No.	Type + Panel (glass)	Entrance (mm)	Dimensions (mm)
0YVG0100Z1	BLDP4-120 white+glass Transparent	493	1170-1210
0YVG0100ZG	BLDP4-120 white+glass Grape		
0YVGC00Z1	BLDP4-120 bright alu+glass Transparent		
0YVGC00ZG	BLDP4-120 bright alu+glass Grape		
0YVG0U00Z1	BLDP4-120 satin+glass Transparent		
0YVG0U00ZG	BLDP4-120 satin+glass Grape		
0YVJ0100Z1	■ BLDP4-130 white+glass Transparent	543	1270-1310
0YVJ0100ZG	■ BLDP4-130 white+glass Grape		
0YVJ0C00Z1	■ BLDP4-130 bright alu+glass Transparent		
0YVJ0C00ZG	■ BLDP4-130 bright alu+glass Grape		
0YVJ0U00Z1	■ BLDP4-130 satin+glass Transparent		
0YVJ0U00ZG	■ BLDP4-130 satin+glass Grape		
0YVM0100Z1	■ BLDP4-140 white+glass Transparent	593	1370-1410
0YVM0100ZG	■ BLDP4-140 white+glass Grape		
0YVM0C00Z1	■ BLDP4-140 bright alu+glass Transparent		
0YVM0C00ZG	■ BLDP4-140 bright alu+glass Grape		
0YVM0U00Z1	■ BLDP4-140 satin+glass Transparent		
0YVM0U00ZG	■ BLDP4-140 satin+glass Grape		
0YVP0100Z1	■ BLDP4-150 white+glass Transparent	643	1470-1510
0YVP0100ZG	■ BLDP4-150 white+glass Grape		
0YVP0C00Z1	■ BLDP4-150 bright+glass Transparent		
0YVP0C00ZG	■ BLDP4-150 bright alu+glass Grape		
0YVP0U00Z1	■ BLDP4-150 satin+glass Transparent		
0YVP0U00ZG	■ BLDP4-150 satin+glass Grape		
0YVS0100Z1	■ BLDP4-160 white+glass Transparent	693	1570-1610
0YVS0100ZG	■ BLDP4-160 white+glass Grape		
0YVS0C00Z1	■ BLDP4-160 bright alu+glass Transparent		
0YVS0C00ZG	■ BLDP4-160 bright alu+glass Grape		
0YVS0U00Z1	■ BLDP4-160 satin+glass Transparent		
0YVS0U00ZG	■ BLDP4-160 satin+glass Grape		
0YVV0100Z1	■ BLDP4-170 white+glass Transparent	743	1670-1710
0YVV0100ZG	■ BLDP4-170 white+glass Grape		
0YVV0C00Z1	■ BLDP4-170 bright alu+glass Transparent		
0YVV0C00ZG	■ BLDP4-170 bright alu+glass Grape		
0YVV0U00Z1	■ BLDP4-170 satin+glass Transparent		
0YVV0U00ZG	■ BLDP4-170 satin+glass Grape		
0YVY0100Z1	■ BLDP4-180 white+glass Transparent	793	1770-1810
0YVY0100ZG	■ BLDP4-180 white+glass Grape		
0YVY0C00Z1	■ BLDP4-180 bright alu+glass Transparent		
0YVY0C00ZG	■ BLDP4-180 bright alu+glass Grape		
0YVY0U00Z1	■ BLDP4-180 satin+glass Transparent		
0YVY0U00ZG	■ BLDP4-180 satin+glass Grape		
0YVL0100Z1	■ BLDP4-190 white+glass Transparent	843	1870-1910
0YVL0100ZG	■ BLDP4-190 white+glass Grape		
0YVL0C00Z1	■ BLDP4-190 bright alu+glass Transparent		
0YVL0C00ZG	■ BLDP4-190 bright alu+glass Grape		
0YVL0U00Z1	■ BLDP4-190 satin+glass Transparent		
0YVL0U00ZG	■ BLDP4-190 satin+glass Grape		
0YVK0100Z1	■ BLDP4-200 white+glass Transparent	893	1970-2010
0YVK0100ZG	■ BLDP4-200 white+glass Grape		
0YVK0C00Z1	■ BLDP4-200 bright alu+glass Transparent		
0YVK0C00ZG	■ BLDP4-200 bright alu+glass Grape		
0YVK0U00Z1	■ BLDP4-200 satin+glass Transparent		
0YVK0U00ZG	■ BLDP4-200 satin+glass Grape		

Finish

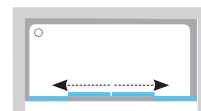
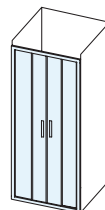

**Recommended shower trays:** Gigant, Gigant Pro, Gigant Pro Flat, Gigant Pro Chrome.

Product height 1900 mm.

■ 6 week delivery time.

For details about frames and panels, see page 28. Other design options are available in the Custom Solution Configurator at <https://atypical.ravak.com>

Products are as standard delivered within 14 days.

Note: Pay attention to technical documentation before installing your shower enclosure. The number provided in the name of the product does not indicate its exact size. More at [www.ravak.com](http://www.ravak.com).

When installing a shower enclosure directly on the floor (without a shower tray), refer to the document entitled Constructional preparation found in the Customised Shower Enclosures section at [www.ravak.com](http://www.ravak.com).



**SILENT OPERATION**  
Silent operation of your shower enclosure

BLPS	Fixed screen	
Order No.	Type + Panel (glass)	Dimensions (mm)
9BH40100Z1	BLPS-80 white+glass Transparent	770-790
9BH40100ZG	BLPS-80 white+glass Grape	
9BH40C00Z1	BLPS-80 bright alu+glass Transparent	
9BH40C00ZG	BLPS-80 bright alu+glass Grape	
9BH40U00Z1	BLPS-80 satin+glass Transparent	
9BH40U00ZG	BLPS-80 satin+glass Grape	
9BH70100Z1	BLPS-90 white+glass Transparent	870-890
9BH70100ZG	BLPS-90 white+glass Grape	
9BH70C00Z1	BLPS-90 bright alu+glass Transparent	
9BH70C00ZG	BLPS-90 bright alu+glass Grape	
9BH70U00Z1	BLPS-90 satin+glass Transparent	
9BH70U00ZG	BLPS-90 satin+glass Grape	
9BHA0100Z1	BLPS-100 white+glass Transparent	970-990
9BHA0100ZG	BLPS-100 white+glass Grape	
9BHA0C00Z1	BLPS-100 bright alu+glass Transparent	
9BHA0C00ZG	BLPS-100 bright alu+glass Grape	
9BHA0U00Z1	BLPS-100 satin+glass Transparent	
9BHA0U00ZG	BLPS-100 satin+glass Grape	

**Finish**

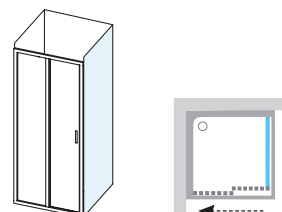

**Recommended shower trays:** Perseus, Perseus Pro, Perseus Pro Flat, Perseus Pro Chrome, Gigant, Gigant Pro, Gigant Pro Flat, Gigant Pro Chrome.

Product height 1900 mm.

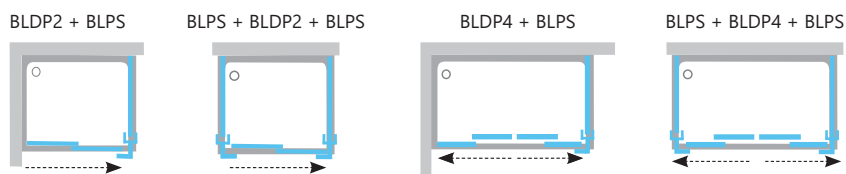
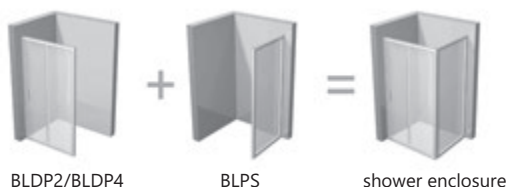

**Usage possibilities:** Combine the BLPS fixed wall and the selected shower door to obtain a square or rectangular shower enclosure in various dimensions. You can choose from the above combinations.

For the completion of the shower enclosure, at least 2 items of the product must be ordered. This will create the total price of the shower enclosure.

For details about frames and panels, see page 28. Other design options are available in the Custom Solution Configurator at <https://atypical.ravak.com>

Products are as standard delivered within 14 days.

Note: Pay attention to technical documentation before installing your shower enclosure. The number provided in the name of the product does not indicate its exact size. More at [www.ravak.com](http://www.ravak.com).

When installing a shower enclosure directly on the floor (without a shower tray), refer to the document entitled Constructional preparation found in the Customised Shower Enclosures section at [www.ravak.com](http://www.ravak.com).



5

NOW 5 YEAR WARRANTY FOR ALL SHOWER ENCLOSURES AND DOORS



EASY INSTALLATION  
Frame installation requires only a few screws



GLASS PROTECTION  
The glass is protected by RAVAK AntiCalc® surface treatment technology

### BLDZ2 Shower doors (for niches or in combination with BLPSZ)

Order No.	Type + Panel (glass)	Entrance (mm)	Dimensions (mm)
X01H10C00Z1	BLDZ2-70 bright alu+Transparent	453	670-710
X01H40C00Z1	BLDZ2-80 bright alu+Transparent	553	770-810
X01H70C00Z1	BLDZ2-90 bright alu+Transparent	654	870-910

Product height 1900 mm.

Finish

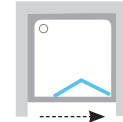

**Recommended shower trays:** Aneta, Angela, Perseus, Perseus Pro, Perseus Pro Flat, Perseus Pro Chrome, Gigant, Gigant Pro, Gigant Pro Flat, Gigant Pro Chrome.

### BLPSZ Fixed screen (for combining with BLDZ2)

Order No.	Type + Panel (glass)	Dimensions (mm)
X93H40C00Z1	BLPSZ-80 bright alu+Transparent	780-800
X93H70C00Z1	BLPSZ-90 bright alu+Transparent	880-900

Product height 1900 mm.

Finish

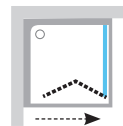
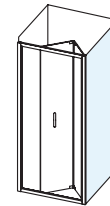

**Recommended shower trays:** Aneta, Angela, Perseus, Perseus Pro, Perseus Pro Flat, Perseus Pro Chrome, Gigant, Gigant Pro, Gigant Pro Flat, Gigant Pro Chrome.

For the completion of the shower enclosure, at least 2 items of the product must be ordered. This will create the total price of the shower enclosure.

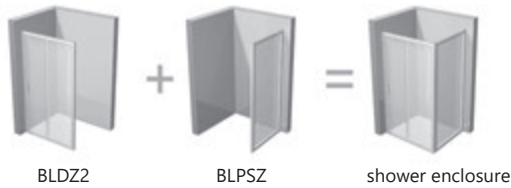

For details about frames and panels, see page 28. Other design options are available in the Custom Solution Configurator at <https://atypical.ravak.com>

Products are as standard delivered within 14 days.

Note: Pay attention to technical documentation before installing your shower enclosure. The number provided in the name of the product does not indicate its exact size. More at [www.ravak.com](http://www.ravak.com).

When installing a shower enclosure directly on the floor (without a shower tray), refer to the document entitled Constructional preparation found in the Customised Shower Enclosures section at [www.ravak.com](http://www.ravak.com).



SILENT OPERATION  
Silent operation of your shower enclosure

**BLNPS** Extension profile

Order No.	Type	Height (mm)
E77880111900B	BLNPS white	1900
E778801C1900B	BLNPS bright alu	
E778801U1900B	BLNPS satin	

Finish



**Usage possibilities:** Can be used for all Blix products. (except BLDP4, BLDZ2, BLPSZ).

**Fixing profiles and extension profiles**



EXTENSION PROFILE

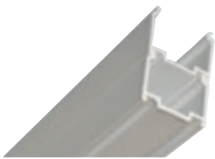

**Extension profiles**  
Make it possible to extend the shower enclosure or door by 2 cm on each side.  
**Extension profiles are available for the following ranges: Pivot, 10°, Blix, and Supernova.**



**Fixing profile**  
Used for mounting the shower enclosure or door to the wall.  
**Not sold separately, this profile is included as standard with any product where necessary.**

Now 10 cm taller  
and also in black.







# Supernova

The most reliable and now  
even taller

Now 10 cm taller

Models in premium height look better in the bathroom  
while ensuring comfortable entry into the shower.



**Absolutely Reliable**

Thickened profiles and patented AntiBlock  
system allow it to serve you reliably for years  
even under frequent use or rougher handling.

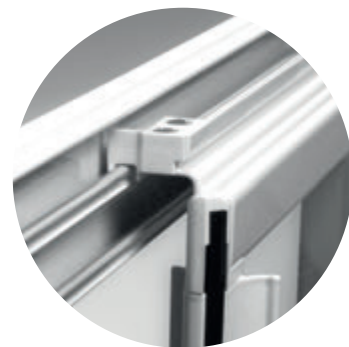

# Quadrant shower enclosures



## **SKCP4 - Four-part quadrant sliding shower enclosure**

The best selling framed shower enclosure. It features a durable frame structure and high-quality surface finish.



Do your children love taking baths? They can enjoy daily bathing even in a small bathroom thanks to the deep seating shower tray.

► see p. 146

## **SKCP4 Sabina - Four-part quadrant sliding shower enclosure with a reduced height**

A 'short' variant of the previous model. The shower enclosure is designed for combination with the Sabina deep seating shower tray. It combines the advantages of baths and shower enclosures.



## Quadrant shower enclosures

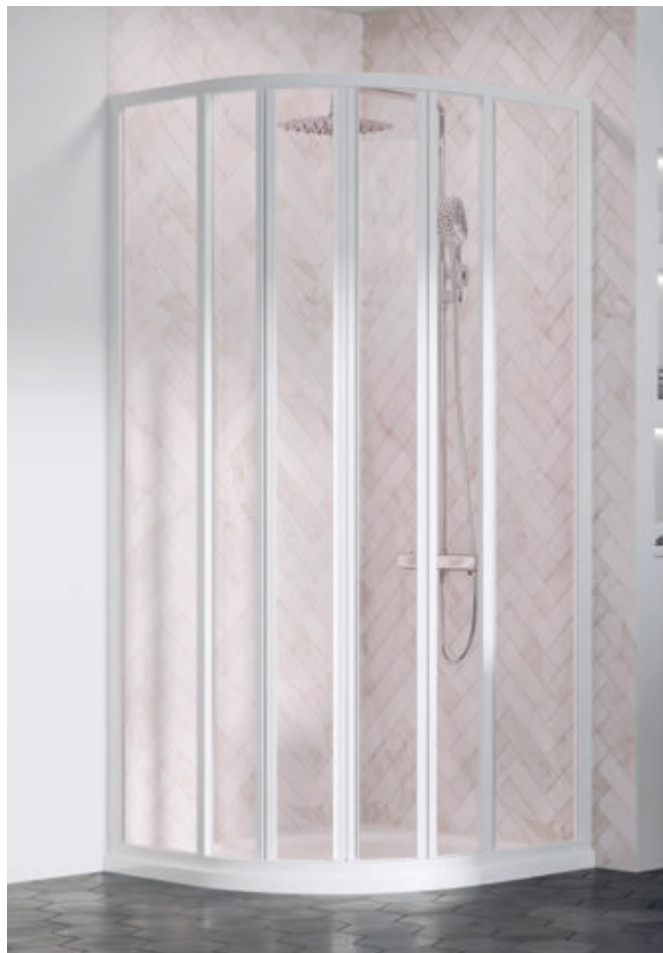

### **SKKP6** - Six-part quadrant sliding shower enclosure

Flat panels divided in six sections guarantee trouble-free use and are nearly indestructible.

**Very easy installation.**

The product comes ready assembled, you just need to screw it to the wall and seal it off.



► Design on p. 121-126

## Corner shower enclosures



### **SRV2-S + SRV2-S** - Four-part corner entry sliding shower enclosure

The best value shower enclosure of the Supernova range. To obtain a square-shaped or a rectangular-shaped shower enclosure, combine different dimensions of the SRV2-S product.

**Enjoy more comfort in your shower enclosure with a seat, see p. 130.**





# Corner shower enclosures



## **ASRV3 + ASRV3 - Six-part corner entry sliding shower enclosure**

It features the widest entry of all Supernova corner shower enclosures. To obtain a square-shaped or a rectangular-shaped shower enclosure, combine different dimensions of the ASRV3 product.

**Framed shower enclosures provide optimal protection from water leaking into the bathroom. The taller the bottom horizontal profile, the better the protection. The shower enclosure or door will thus hold water inside the shower enclosure even during intense showering.**



**If you use the shower door with fixed wall, you can easily place a washing machine next to the shower enclosure.**

## **ASDP3 + APSS - shower door + fixed wall, with front entry**

A shower enclosure tailored to your needs. Combine a shower door and a fixed wall to create a showering space in dimensions up to 120 x 90 cm.

# Supernova Shower Door



## **ASDP3** - Three-part sliding shower door

Extremely durable, practically unbreakable shower door. Ideal solution also for busy public areas.



## **SDZ2** - Two-part folding shower door

Suited to the smallest rooms in dimensions of 67 - 71 cm. The folding door enables maximum entrance width.

► Design on p. 120-126

# Shower Door



## **SDZ3 - Three-part folding shower door**

A wider version of the previous model. Suitable for bathrooms in widths of 77 - 101 cm.

The SDZ2, SDZ3 and SDOP shower doors can be combined with the PSS fixed walls only. The ASDP3 shower doors are compatible with the APSS fixed walls only.



## **SDOP - Pivot turning shower door**

This is the simplest construction variant of shower door in this range and therefore the best value.





new

## Quadrant shower enclosures



### **SKCP4 black** - Four-part quadrant sliding shower enclosure

The best selling framed shower enclosure. It features a durable frame structure and high-quality surface finish.

## Corner shower enclosures



### **SRV2-S black + SRV2-S black** - Four-part corner entry sliding shower enclosure

The best value shower enclosure of the Supernova range. To obtain a square-shaped or a rectangular-shaped shower enclosure, combine different dimensions of the SRV2-S product.

### **SKKP6 black** - Six-part quadrant sliding shower enclosure

The best value quadrant shower enclosure of the RAVAK range. With the straight panels divided into six parts, it provides absolute indestructibility.





## Corner shower enclosures

**ASRV3 black + ASRV3 black - Six-part corner entry sliding shower enclosure**

It features the widest entry of all Supernova corner shower enclosures. To obtain a square-shaped or a rectangular-shaped shower enclosure, combine different dimensions of the ASRV3 product.

## Shower Door

**ASDP3 black - Three-part sliding shower door**

Extremely durable, practically unbreakable shower door. Ideal solution also for busy public areas.

**ASDP3 black + APSS black - shower door + fixed wall, with front entry**

A shower enclosure tailored to your needs. Combine a shower door and a fixed wall to create a showering space in dimensions up to 120 x 90 cm.



# Supernova

5

NOW 5 YEAR WARRANTY FOR ALL SHOWER ENCLOSURES AND DOORS

10

10 YEAR WARRANTY FOR ANTIBLOCK  
We provide a 10-year warranty on the AntiBlock mechanism



EASY INSTALLATION  
Very easy installation  
Comes assembled

## SKCP4 Shower enclosure

Order No.	Type + Panel (glass/plastic)	Entrance (mm)	Dimensions (mm)
3114O10211	SKCP4-80 195 white + polystyrene Pearl	500	775-795x775-795
3114O102Z1	SKCP4-80 195 white+glass Transparent		
3114O102ZG	SKCP4-80 195 white+glass Grape		
3114OU0211	SKCP4-80 195 satin+polystyrene Pearl		
3114OU02Z1	SKCP4-80 195 satin+glass Transparent		
3114OU02ZG	SKCP4-80 195 satin+glass Grape		
3114O30211	SKCP4-80 195 black+polystyrene Pearl		
3114O302Z1	SKCP4-80 195 black+glass Transparent		
3114O302ZG	SKCP4-80 195 black+glass Grape		
3117O10211	SKCP4-90 195 white+polystyrene Pearl		
3117O102Z1	SKCP4-90 195 white+glass Transparent		
3117O102ZG	SKCP4-90 195 white+glass Grape		
3117OU0211	SKCP4-90 195 satin+polystyrene Pearl		
3117OU02Z1	SKCP4-90 195 satin+glass Transparent		
3117OU02ZG	SKCP4-90 195 satin+glass Grape		
3117O30211	SKCP4-90 195 black+polystyrene Pearl		
3117O302Z1	SKCP4-90 195 black+glass Transparent		
3117O302ZG	SKCP4-90 195 black+glass Grape		

Product height 1950 mm.

Delivery time for designs in black colour is up to 5 weeks.

### Finish

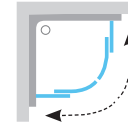
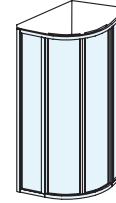
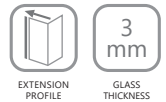

**Recommended shower trays:** Ronda, Elipso, Elipso Pro, Elipso Pro Flat, Elipso Pro Chrome, Sabina.

You can also assemble a SKCP4 shower enclosure by using the PSS fixed screen on one side. You will then only need one partition to complete the shower enclosure.

## SKCP4 Sabina Shower enclosure

Order No.	Type + Panel (glass/plastic)	Entrance (mm)	Dimensions (mm)
31144V10011	SKCP4-80 SABINA white+polystyrene Pearl	500	775-795x775-795
31144VU0011	SKCP4-80 SABINA satin+polystyrene Pearl		
31177V10011	SKCP4-90 SABINA white+polystyrene Pearl	550	875-895x875-895
31177VU0011	SKCP4-90 SABINA satin+polystyrene Pearl		

Product height 1700 mm.

### Finish

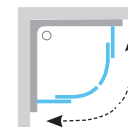
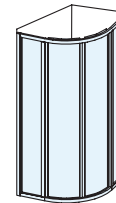

**Recommended shower trays:** Sabina.

## SKKP6 Shower enclosure

Order No.	Type + Panel (glass/plastic)	Entrance (mm)	Dimensions (mm)
3204O10211	SKKP6-80 195 white+polystyrene Pearl	460	775-795x775-795
3204O102Z1	SKKP6-80 195 white+glass Transparent		
3204O102ZG	SKKP6-80 195 white+glass Grape		
3204O30211	SKKP6-80 195 black+polystyrene Pearl		
3204O302Z1	SKKP6-80 195 black+glass Transparent		
3204O302ZG	SKKP6-80 195 black+glass Grape		
3207O10211	SKKP6-90 195 white+polystyrene Pearl	550	875-895x875-895
3207O102Z1	SKKP6-90 195 white+glass Transparent		
3207O102ZG	SKKP6-90 195 white+glass Grape		
3207O30211	SKKP6-90 195 black+polystyrene Pearl		
3207O302Z1	SKKP6-90 195 black+glass Transparent		
3207O302ZG	SKKP6-90 195 black+glass Grape		

Product height 1950 mm.

Delivery time for designs in black colour is up to 5 weeks.

### Finish

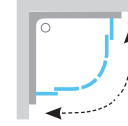
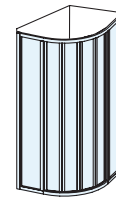
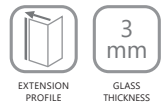

**Recommended shower trays:** Ronda, Elipso, Elipso Pro, Elipso Pro Flat, Elipso Pro Chrome.

You can also assemble a SKKP6 shower enclosure by using the PSS fixed screen on one side. You will then only need one partition to complete the shower enclosure.

For details about frames and panels, see page 28. Other design options are available in the Custom Solution Configurator at <https://atypical.ravak.com>

The radius of the quarter-circle shower enclosures is R500. Products are as standard delivered within 14 days.

Note: Pay attention to technical documentation before installing your shower enclosure. The number provided in the name of the product does not indicate its exact size. More at [www.ravak.com](http://www.ravak.com).

When installing a shower enclosure directly on the floor (without a shower tray), refer to the document entitled Constructional preparation found in the Customised Shower Enclosures section at [www.ravak.com](http://www.ravak.com).



GLASS PROTECTION

The glass is protected by RAVAK AntiCalc® surface treatment technology

**SRV2-S + SRV2-S** Shower enclosure

Order No.	Type + Panel (glass/plastic)	Entrance (mm)	Dimensions (mm)
14V301O211	SRV2-75 195 S white+polystyrene Pearl	396	720 -740
14V301O2Z1	SRV2-75 195 S white+glass Transparent		
14V301O2ZG	■ SRV2-75 195 S white+glass Grape		
14V30UO211	SRV2-75 195 S satin+glass Transparent		
14V30UO211	SRV2-75 195 S satin+polystyrene Pearl		
14V30UO2ZG	■ SRV2-75 195 S satin+glass Grape		
14V303O211	SRV2-75 195 S black+polystyrene Pearl	431	770 - 790
14V303O2Z1	SRV2-75 195 S black+glass Transparent		
14V303O2ZG	SRV2-75 195 S black+glass Grape		
14V401O211	SRV2-80 195 S white+polystyrene Pearl		
14V401O2Z1	SRV2-80 195 S white+glass Transparent		
14V401O2ZG	■ SRV2-80 195 S white+glass Grape		
14V40UO211	SRV2-80 195 S satin+glass Transparent	504	870 - 890
14V40UO211	SRV2-80 195 S satin+polystyrene Pearl		
14V40UO2ZG	■ SRV2-80 195 S satin+glass Grape		
14V403O211	SRV2-80 195 S black+polystyrene Pearl		
14V403O2Z1	SRV2-80 195 S black+glass Transparent		
14V403O2ZG	SRV2-80 195 S black+glass Grape		
14V701O211	SRV2-90 195 S white+polystyrene Pearl	530	970 - 990
14V701O2Z1	SRV2-90 195 S white+glass Transparent		
14V701O2ZG	■ SRV2-90 195 S white+glass Grape		
14V70UO211	SRV2-90 195 S satin+polystyrene Pearl		
14V70UO2Z1	SRV2-90 195 S satin+glass Transparent		
14V70UO2ZG	■ SRV2-90 195 S satin+glass Grape		
14V703O211	SRV2-90 195 S black+polystyrene Pearl	530	970 - 990
14V703O2Z1	SRV2-90 195 S black+glass Transparent		
14V703O2ZG	SRV2-90 195 S black+glass Grape		
14VA01O211	SRV2-100 195 S white+polystyrene Pearl		
14VA01O2Z1	SRV2-100 195 S white+glass Transparent		
14VA01O2ZG	■ SRV2-100 195 S white+glass Grape		
14VA0UO211	SRV2-100 195 S satin+glass Transparent	530	970 - 990
14VA0UO211	SRV2-100 195 S satin+polystyrene Pearl		
14VA0UO2ZG	■ SRV2-100 195 S satin+glass Grape		
14VA03O211	SRV2-100 195 S black+polystyrene Pearl		
14VA03O2Z1	SRV2-100 195 S black+glass Transparent		
14VA03O2ZG	SRV2-100 195 S black+glass Grape		

Product height 1950mm.

■ 6 week delivery time.

Delivery time for designs in black colour is up to 5 weeks.

Finish

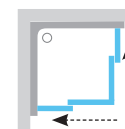
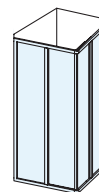

**Recommended shower trays:** Aneta, Angela, Perseus, Perseus Pro, Perseus Pro Flat, Perseus Pro Chrome, Gigant, Gigant Pro, Gigant Pro Flat, Gigant Pro Chrome.

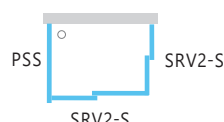
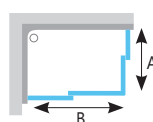

**Possible combination:**

- A - SRV2-S - choose dimensions 75 - 100 cm
- B - SRV2-S - choose dimensions 75 - 100 cm.

To complete your shower enclosure, it is necessary to always order at least two SRV2 products of the same height. The sum will then be the total price of the shower enclosure.

You can also assemble an SRV2 + SRV2 shower enclosure by using the PSS fixed screen to create a U shape. You will then only need one partition to complete the shower enclosure.

For details about frames and panels, see page 28. Other design options are available in the Custom Solution Configurator at <https://atypical.ravak.com>

Products are as standard delivered within 14 days.

Note: Pay attention to technical documentation before installing your shower enclosure. The number provided in the name of the product does not indicate its exact size. More at [www.ravak.com](http://www.ravak.com).

When installing a shower enclosure directly on the floor (without a shower tray), refer to the document entitled Constructional preparation found in the Customised Shower Enclosures section at [www.ravak.com](http://www.ravak.com).



NOW 5 YEAR WARRANTY FOR ALL SHOWER ENCLOSURES AND DOORS



10 YEAR WARRANTY FOR ANTIBLOCK  
We provide a 10-year warranty on the AntiBlock mechanism



EASY INSTALLATION  
Very easy installation  
Comes assembled

## ASRV3 + ASRV3 Shower enclosure

Order No.	Type + Panel (glass/plastic)	Entrance (mm)	Dimensions (mm)
15V301R211	ASRV3-75 198 white+polystyrene Pearl	495	720 - 740
15V301R2Z1	■ ASRV3-75 198 white+glass Transparent		
15V301R2ZG	■ ASRV3-75 198 white+glass Grape		
15V30UR2Z1	■ ASRV3-75 198 satin+glass Transparent		
15V30UR211	ASRV3-75 198 satin+polystyrene Pearl		
15V30UR2ZG	■ ASRV3-75 198 satin+glass Grape		
15V303R211	ASRV3-75-198 black+polystyrene Pearl		
15V303R2Z1	ASRV3-75-198 black+glass Transparent		
15V303R2ZG	ASRV3-75-198 black+glass Grape		
15V401R211	ASRV3-80 198 white+polystyrene Pearl	543	770 - 790
15V401R2Z1	ASRV3-80 198 white+glass Transparent		
15V401R2ZG	ASRV3-80 198 white+glass Grape		
15V40UR211	ASRV3-80 198 satin+polystyrene Pearl		
15V40UR2Z1	ASRV3-80 198 satin+glass Transparent		
15V40UR2ZG	ASRV3-80 198 satin+glass Grape		
15V403R211	ASRV3-80-198 black+polystyrene Pearl		
15V403R2Z1	ASRV3-80-198 black+glass Transparent		
15V403R2ZG	ASRV3-80-198 black+glass Grape		
15V701R211	ASRV3-90 198 white+polystyrene Pearl	635	870 - 890
15V701R2Z1	ASRV3-90 198 white+glass Transparent		
15V701R2ZG	ASRV3-90 198 white+glass Grape		
15V70UR211	ASRV3-90 198 satin+polystyrene Pearl		
15V70UR2Z1	ASRV3-90 198 satin+glass Transparent		
15V70UR2ZG	ASRV3-90 198 satin+glass Grape		
15V703R211	ASRV3-90-198 black+polystyrene Pearl		
15V703R2Z1	ASRV3-90-198 black+glass Transparent		
15V703R2ZG	ASRV3-90-198 black+glass Grape		

### Finish

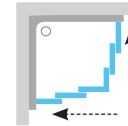
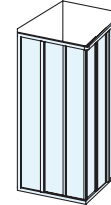

**Recommended shower trays:** Aneta, Angela, Perseus, Perseus Pro, Perseus Pro Flat, Perseus Pro Chrome.

- Product height 1980 mm.
- 6 week delivery time.
- Delivery time for designs in black colour is up to 5 weeks.



### Possible combination:

- A – ASRV3 – custom size 75 – 90 cm.
- B – ASRV3 – custom size 75 – 90 cm.

To complete your shower enclosure, it is necessary to always order at least two ASRV3 products. The sum will then be the total price of the shower enclosure.

You can also assemble an ASRV3 + ASRV3 shower enclosure by using the APSS fixed screen to create a U shape. You will then only need one partition to complete the shower enclosure.

For details about frames and panels, see page 28. Other design options are available in the Custom Solution Configurator at <https://atypical.ravak.com>

Products are as standard delivered within 14 days..

Note: Pay attention to technical documentation before installing your shower enclosure. The number provided in the name of the product does not indicate its exact size. More at [www.ravak.com](http://www.ravak.com).

When installing a shower enclosure directly on the floor (without a shower tray), refer to the document entitled Constructional preparation found in the Customised Shower Enclosures section at [www.ravak.com](http://www.ravak.com).





## GLASS PROTECTION

The glass is protected by RAVAK  
AntiCalc® surface treatment technology

## ASDP3 Shower doors (for niches or in combination with APSS)

Order No.	Type + Panel (glass/plastic)	Entrance (mm)	Dimensions (mm)
00V401R211	ASDP3-80 198 white+polystyrene Pearl	395	770 - 810
00V401R2Z1	Shower doors ASDP3-80 198 white+glass Transparent		
00V401R2ZG	Shower doors ASDP3-80 198 white+glass Grape		
00V40UR211	ASDP3-80 198 satin+ polystyrene Pearl		
00V40UR2Z1	ASDP3-80 198 satin+glass Transparent		
00V40UR2ZG	ASDP3-80 198 satin+glass Grape		
00V403R211	ASDP3-80 198 black+polystyrene Pearl		
00V403R2Z1	ASDP3-80 198 black+glass Transparent		
00V403R2ZG	ASDP3-80 198 black+glass Grape		
00V701R211	ASDP3-90 198 white+polystyrene Pearl		
00V701R2Z1	ASDP3-90 198 white+glass Transparent		
00V701R2ZG	ASDP3-90 198 white+glass Grape		
00V70UR211	ASDP3-90 198 satin+polystyrene Pearl		
00V70UR2Z1	ASDP3-90 198 satin+glass Transparent		
00V70UR2ZG	ASDP3-90 198 satin+glass Grape		
00V703R211	ASDP3-90 198 black+polystyrene Pearl		
00V703R2Z1	ASDP3-90 198 black+glass Transparent		
00V703R2ZG	ASDP3-90 198 black+glass Grape		
00VA01R211	Shower doors ASDP3-100 198 white+polystyrene Pearl	528	970 - 1010
00VA01R2Z1	Shower doors ASDP3-100 198 white+glass Transparent		
00VA01R2ZG	Shower doors ASDP3-100 198 white+glass Grape		
00VA0UR211	ASDP3-100 198 satin+polystyrene Pearl		
00VA0UR2Z1	ASDP3-100 198 satin+glass Transparent		
00VA0UR2ZG	ASDP3-100 198 satin+glass Grape		
00VA03R211	ASDP3-100 198 black+polystyrene Pearl		
00VA03R2Z1	ASDP3-100 198 black+glass Transparent		
00VA03R2ZG	ASDP3-100 198 black+glass Grape		
00VD01R211	Shower doors ASDP3-110 198 white+polystyrene Pearl		
00VD01R2Z1	■ Shower doors ASDP3-110 198 white+glass Transparent		
00VD01R2ZG	■ Shower doors ASDP3-110 198 white+glass Grape		
00VD0UR2Z1	■ Shower doors ASDP3-110 198 satin+glass Transparent		
00VD0UR211	Shower doors ASDP3-110 198 satin+polystyrene Pearl		
00VD0UR2ZG	■ Shower doors ASDP3-110 198 satin+glass Grape		
00VD03R211	ASDP3-110 198 black+polystyrene Pearl		
00VD03R2Z1	ASDP3-110 198 black+glass Transparent		
00VD03R2ZG	ASDP3-110 198 black+glass Grape		
00VG01R211	ASDP3-120 198 white+polystyrene Pearl	661	1170 - 1210
00VG01R2Z1	■ ASDP3-120 198 white+glass Transparent		
00VG01R2ZG	■ ASDP3-120 198 white+glass Grape		
00VG0UR211	ASDP3-120 198 satin+polystyrene Pearl		
00VG0UR2Z1	■ ASDP3-120 198 satin+glass Transparent		
00VG0UR2ZG	■ ASDP3-120 198 satin+glass Grape		
00VG03R211	ASDP3-120 198 black+polystyrene Pearl		
00VG03R2Z1	ASDP3-120 198 black+glass Transparent		
00VG03R2ZG	ASDP3-120 198 black+glass Grape		
00VJ01R211	ASDP3-130 198 white+polystyrene Pearl		
00VJ01R2Z1	■ ASDP3-130 198 white+glass Transparent		
00VJ01R2ZG	■ ASDP3-130 198 white+glass Grape		
00VJ0UR211	ASDP3-130 198 satin+polystyrene Pearl		
00VJ0UR2Z1	■ ASDP3-130 198 satin+glass Transparent		
00VJ0UR2ZG	■ ASDP3-130 198 satin+glass Grape		
00VJ03R211	ASDP3-130 198 black+polystyrene Pearl		
00VJ03R2Z1	ASDP3-130 198 black+glass Transparent		
00VJ03R2ZG	ASDP3-130 198 black+glass Grape		

Product height 1980 mm.

■ 6 week delivery time.

Delivery time for designs in black colour is up to 5 weeks.

## Finish

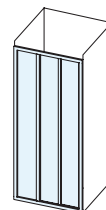

**Recommended shower trays:** Aneta, Angela, Perseus, Perseus Pro, Perseus Pro Flat, Perseus Pro Chrome, Gigant, Gigant Pro, Gigant Pro Flat, Gigant Pro Chrome.

For details about frames and panels, see page 28. Other design options are available in the Custom Solution Configurator at <https://atypical.ravak.com>

Products are as standard delivered within 14 days.

Note: Pay attention to technical documentation before installing your shower enclosure. The number provided in the name of the product does not indicate its exact size. More at [www.ravak.com](http://www.ravak.com).

When installing a shower enclosure directly on the floor (without a shower tray), refer to the document entitled Constructional preparation found in the Customised Shower Enclosures section at [www.ravak.com](http://www.ravak.com).



NOW 5 YEAR WARRANTY FOR ALL SHOWER ENCLOSURES AND DOORS



10 YEAR WARRANTY FOR ANTIBLOCK  
We provide a 10-year warranty on the AntiBlock mechanism



EASY INSTALLATION  
Very easy installation  
Comes assembled

### SDZ2 Shower doors (for niches or in combination with PSS)

Order No.	Type + Panel (glass/plastic)	Entrance (mm)	Dimensions (mm)
01V101O211	SDZ2-70 195 white+polystyrene Pearl	492	670 - 710
01V101O2Z1	SDZ2-70 195 white+glass Transparent		
01V101O2ZG	SDZ2-70 195 white+glass Grape		

Product height 1950 mm.

Finish

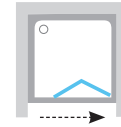
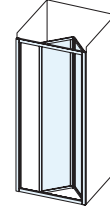

**We recommend:** Install directly onto the floor with an embedded shower channel or floor drain.

### SDZ3 Shower doors (for niches or in combination with PSS)

Order No.	Type + Panel (glass/plastic)	Entrance (mm)	Dimensions (mm)
02V401O211	SDZ3-80 195 white+polystyrene Pearl	510	770 - 810
02V401O2Z1	SDZ3-80 195 white+glass Transparent		
02V401O2ZG	SDZ3-80 195 white+glass Grape		
02V701O211	SDZ3-90 195 white+polystyrene Pearl	610	870 - 910
02V701O2Z1	SDZ3-90 195 white+glass Transparent		
02V701O2ZG	SDZ3-90 195 white+glass Grape		
02VA01O211	SDZ3-100 195 white+polystyrene Pearl	610	970 - 1010
02VA01O2Z1	■ SDZ3-100 195 white+glass Transparent		
02VA01O2ZG	■ SDZ3-100 195 white+glass Grape		

Product height 1950 mm.

■ 6 week delivery time.

Finish

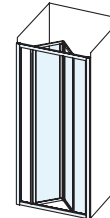

**Recommended shower trays:** Aneta, Angela, Perseus, Perseus Pro, Perseus Pro Flat, Perseus Pro Chrome, Gigant, Gigant Pro, Gigant Pro Flat, Gigant Pro Chrome.

### SDOP Shower doors (for niches or in combination with PSS)

Order No.	Type + Panel (glass/plastic)	Entrance (mm)	Dimensions (mm)
03V401O211	SDOP-80 195 white+polystyrene Pearl	485	773 - 810
03V401O2Z1	SDOP-80 195 white+glass Transparent		
03V401O2ZG	SDOP-80 195 white+glass Grape		
03V701O211	SDOP-90 195 white+polystyrene Pearl	485	873 - 910
03V701O2Z1	SDOP-90 195 white+glass Transparent		
03V701O2ZG	SDOP-90 195 white+glass Grape		

Product height 1950 mm.

Finish

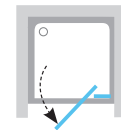
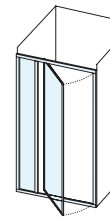

**Recommended shower trays:** Aneta, Angela, Perseus, Perseus Pro, Perseus Pro Flat, Perseus Pro Chrome.

For details about frames and panels, see page 28. Other design options are available in the Custom Solution Configurator at <https://atypical.ravak.com>

Products are as standard delivered within 14 days.

Note: Pay attention to technical documentation before installing your shower enclosure. The number provided in the name of the product does not indicate its exact size. More at [www.ravak.com](http://www.ravak.com).

When installing a shower enclosure directly on the floor (without a shower tray), refer to the document entitled Constructional preparation found in the Customised Shower Enclosures section at [www.ravak.com](http://www.ravak.com).



GLASS PROTECTION  
The glass is protected by RAVAK  
AntiCalc® surface treatment technology

**APSS / PSS Fixed screens (for various combinations)**

Order No.	Type + Panel (glass/plastic)	Dimensions (mm)
● 940301R211	APSS-75 198 white+polystyrene Pearl	720 - 755
● 940301R2Z1	APSS-75 198 white+glass Transparent	
● 940301R2ZG	APSS-75 198 white+glass Grape	
● 94030UR211	APSS-75 198 satin+polystyrene Pearl	
● 94030UR2Z1	APSS-75 198 satin+glass Transparent	
● 94030UR2ZG	APSS-75 198 satin+glass Grape	
● 940303R211	APSS-75 198 black+polystyrene Pearl	
● 940303R2Z1	APSS-75 198 black+glass Transparent	
● 940303R2ZG	APSS-75 198 black+glass Grape	
● 940401R211	APSS-80 198 white+polystyrene Pearl	
● 940401R2Z1	■ APSS-80 198 white+glass Transparent	
● 940401R2ZG	APSS-80 198 white+glass Grape	
● 94040UR211	APSS-80 198 satin+polystyrene Pearl	
● 94040UR2Z1	■ APSS-80 198 satin+glass Transparent	
● 94040UR2ZG	APSS-80 198 satin+glass Grape	
● 940403R211	APSS-80 198 black+polystyrene Pearl	
● 940403R2Z1	APSS-80 198 black+glass Transparent	
● 940403R2ZG	APSS-80 198 black+glass Grape	
● 940701R211	APSS-90 198 white+polystyrene Pearl	870 - 905
● 940701R2Z1	APSS-90 198 white+glass Transparent	
● 940701R2ZG	■ APSS-90 198 white+glass Grape	
● 94070UR211	APSS-90 198 satin+polystyrene Pearl	
● 94070UR2Z1	APSS-90 198 satin+glass Transparent	
● 94070UR2ZG	■ APSS-90 198 satin+glass Grape	
● 940703R211	APSS-90 198 black+polystyrene Pearl	
● 940703R2Z1	APSS-90 198 black+glass Transparent	
● 940703R2ZG	APSS-90 198 black+glass Grape	
● 940301O211	PSS-75 195 white+polystyrene Pearl	
● 940301O2Z1	■ PSS-75 195 white+glass Transparent	
● 940301O2ZG	PSS-75 195 white+glass Grape	
● 940401O211	PSS-80 195 white+polystyrene Pearl	770 - 805
● 940401O2Z1	■ PSS-80 195 white+glass Transparent	
● 940401O2ZG	PSS-80 195 white+glass Grape	
● 940701O211	PSS-90 195 white+polystyrene Pearl	870 - 905
● 940701O2Z1	■ PSS-90 195 white+glass Transparent	
● 940701O2ZG	PSS-90 195 white+glass Grape	

- Product height 1980 mm.
- Product height 1950 mm.
- 6 week delivery time.  
Delivery time for designs in black colour is up to 5 weeks.

Finish

SATIN WHITE BLACK

EXTENSION PROFILE GLASS THICKNESS 3 mm SILENT OPERATION

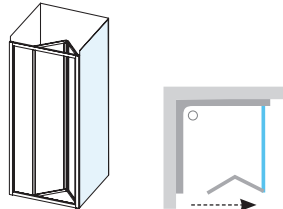

**Recommended shower trays:** Aneta, Angela, Perseus, Perseus Pro, Perseus Pro Flat, Perseus Pro Chrome, Gigant, Gigant Pro, Gigant Pro Flat, Gigant Pro Chrome.

**Usage possibilities:** Combine the APSS or PSS fixed wall and the chosen shower door to obtain a shower enclosure tailored to your bathroom. You can choose from the above combinations.

To complete your shower enclosure, it is necessary to always order at least two products of the same height. The sum will then be the total price of the shower enclosure.

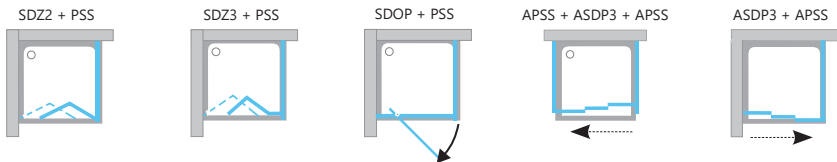
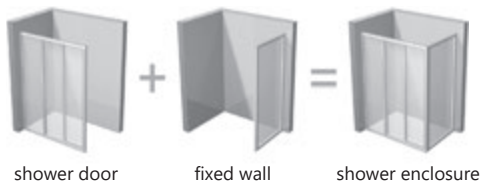

Make sure your products of choice have the same height when combining!

For details about frames and panels, see page 28. Other design options are available in the Custom Solution Configurator at <https://atypical.ravak.com>

Products are as standard delivered within 14 days.  
Note: Pay attention to technical documentation before installing your shower enclosure. The number provided in the name of the product does not indicate its exact size. More at [www.ravak.com](http://www.ravak.com).  
When installing a shower enclosure directly on the floor (without a shower tray), refer to the document entitled Constructional preparation found in the Customised Shower Enclosures section at [www.ravak.com](http://www.ravak.com).



5

NOW 5 YEAR WARRANTY FOR ALL SHOWER ENCLOSURES AND DOORS

10

10 YEAR WARRANTY FOR ANTIBLOCK We provide a 10-year warranty on the AntiBlock mechanism



EASY INSTALLATION Very easy installation Comes assembled

### NPS/ANPS/T profile/AT profile Extension and joining profiles

Order No.	Type	Height (mm)
E7788011195021	Extension profile NPS 195 white	1950
E778801U195021	Extension profile NPS 195 satin	1950
E7788013195021	Extension profile NPS 195 black	1950
E778801119802	Extension profile ANPS 198 white	1980
E778801U19802	Extension profile ANPS 198 satin	1980
E778801319802	Extension profile ANPS 198 black	1980
E119500021	Aluminium profile T 195 white	1950
E119800021	Aluminium profile AT 198 white	1980
E11980002U	Aluminium profile AT 198 satin	1980
E119800023	Aluminium profile AT 198 black	1980

Finish

SATIN WHITE



#### NPS and ANPS

Use the extension profiles NPS and ANPS to extend the shower enclosure or door by 2 cm on each side.



#### T/AT profile

(white/satin)

A connecting profile intended for attaching several shower enclosures or doors in a row divided by fixed walls. Suitable for use in public shower areas.

### Fixing profiles and extension profiles

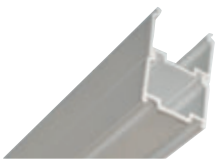

#### Extension profiles

Make it possible to extend the shower enclosure or door by 2 cm on each side.

**Extension profiles are available for the following ranges: Pivot, 10°, Blix, and Supernova.**

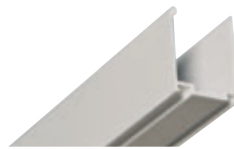

#### Fixing profile

Used for mounting the shower enclosure or door to the wall.

**Not sold separately, this profile is included as standard with any product where necessary.**



#### T/AT profile

(white/satin)

A connecting profile intended for attaching several shower enclosures or doors in a row divided by fixed walls. Suitable for use in public shower areas.

For details about frames and panels, see page 28. Other design options are available in the Custom Solution Configurator at <https://atypical.ravak.com>

Products are as standard delivered within 14 days.

Note: Pay attention to technical documentation before installing your shower enclosure. The number provided in the name of the product does not indicate its exact size. More at [www.ravak.com](http://www.ravak.com).

When installing a shower enclosure directly on the floor (without a shower tray), refer to the document entitled Constructional preparation found in the Customised Shower Enclosures section at [www.ravak.com](http://www.ravak.com).



# Seats

## Relaxation and comfort in the bathroom

The seats take up virtually no space, they have a trendy design, durable rugged construction, high load capacity and can be installed any time indoors and outdoors.





10-year warranty  
on seats



# Chrome



Chrome with white frame (folded up)



Chrome with stainless steel frame (folded up)

## Design in proven quality

Favourite group of the RAVAK seats is offered in the Chrome concept design

- they will fit perfectly in a bathroom in the Chrome concept, but will look nice elsewhere
- they adhere to the high quality of shower seats
- two frame colour options available

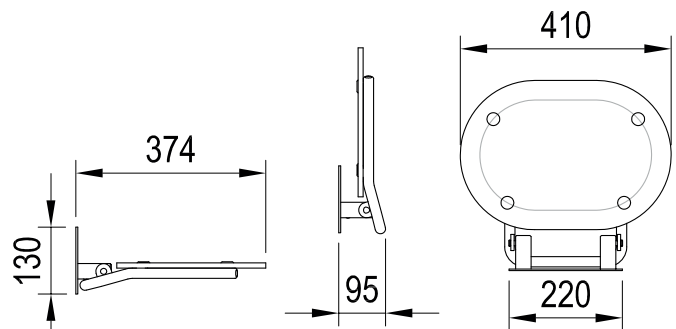

Order No.	Designation (type)	Colour	Dimensions (mm)
B8F0000028	Seat CHROME CLEAR/WHITE	translucent white with white oval	410x374
B8F0000029	Seat CHROME CLEAR/STAINLESS	translucent white with white oval	410x374

Product dimensions are specified as width x depth.  
Products are as standard delivered within 14 days.

# Ovo B II

# Ovo P II



Ovo B II clear

Ovo B II opal

Can be folded up against the wall



Ovo P II clear

Ovo P II opal

Take up only 10 cm from the wall

- **Proven** - 10-year warranty guaranteed
- **Durable** - stainless steel frame will last both in indoor and outdoor settings
- **Robust** - can carry up to 150 kg
- **Beautiful** - innovated design of the mounting board
- **Easy installation**

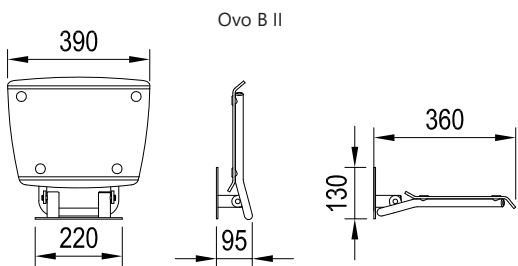

Ovo B II

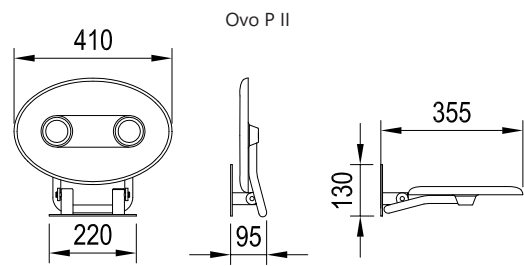

Ovo P II

Order No.	Designation (type)	Colour	Dimensions (mm)
B8F000048	Shower seat OVO-P II-CLEAR	clear	410x355
B8F000049	Shower seat OVO-P II-OPAL	translucent white	410x355
B8F000050	Shower seat OVO-P II-ORANGE	translucent orange	410x355
B8F000051	Shower seat OVO-B II-CLEAR	clear	390x360
B8F000052	Shower seat OVO-B II-OPAL	translucent white	390x360
B8F000053	Shower seat OVO-B II-ORANGE	translucent orange	390x360

Product dimensions are specified as width x depth.  
Products are as standard delivered within 14 days.



# Ovo B II Black

# Ovo P II Black



Design Kryštof Nosál



Ovo B II black orange



Ovo B II black opal



Can be folded up against the wall



Ovo P II black orange



Ovo P II black opal



Take up only 10 cm from the wall

- **Proven** - 10-year warranty guaranteed
- **Durable** - stainless steel frame will last both in indoor and outdoor settings
- **Robust** - can carry up to 150 kg
- **Beautiful** - innovated design of the mounting board
- **Easy installation**

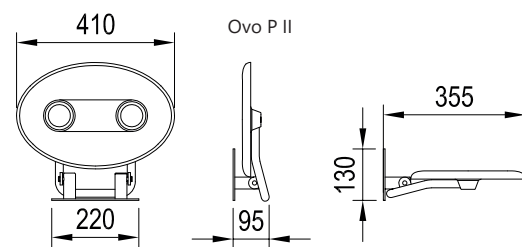
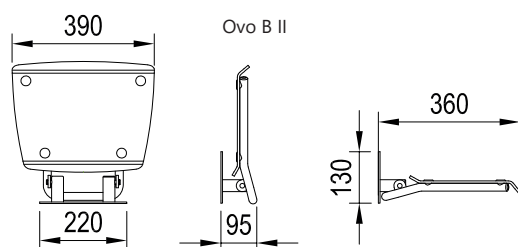

Order No.	Designation (type)	Colour	Dimensions (mm)
B8F0000056	Universal shower seat OVO-P II-CLEAR/BLACK	clear	410x355
B8F0000057	Universal shower seat OVO-P II-OPAL/BLACK	translucent white	410x355
B8F0000058	Universal shower seat OVO-P II-ORANGE/BLACK	translucent orange	410x355
B8F0000059	Universal shower seat OVO-B II-CLEAR/BLACK	clear	390x360
B8F0000060	Universal shower seat OVO-B II-OPAL/BLACK	translucent white	390x360
B8F0000061	Universal shower seat OVO-B II-ORANGE/BLACK	translucent orange	390x360

Product dimensions are specified as width x depth.  
Products are as standard delivered within 14 days.

# Ovo B II Decor

Design Kryštof Nosál



Ovo B II decor - Blueline  
Take up only 10 cm from the wall



Ovo B II decor - Text  
Take up only 10 cm from the wall

## Design seats are particularly suitable for:

- in narrow entrance halls and corridors for putting on shoes
- on a balcony when relaxing
- in public areas and recreation facilities

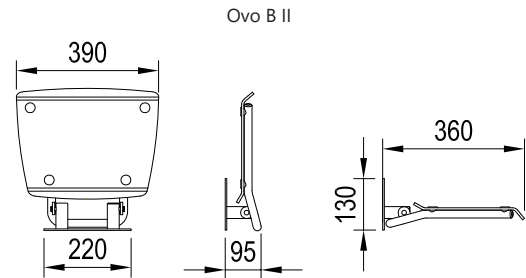

Order No.	Designation (type)	Colour	Dimensions (mm)
B8F000055	Shower seat OVO-B II-BLUELINE	translucent white with blue strips	390x360
B8F000054	Shower seat OVO-B II-TEXT	translucent white with black letters	390x360

Product dimensions are specified as width x depth.  
Products are as standard delivered within 14 days.



# Shower trays, channels and drains

Versatile solution  
to shower enclosure floor

Do you want your ceramic tile effect on the floor or do you prefer smooth beauty of the shower tray? Choose and enjoy everyday comfort in the shower.





# Shower Trays RAVAK

Each of the seven product lines available has its own specific characteristics. Are you going to choose an asymmetric design, an impressive flat design, or a proven classic?

## Galaxy Pro 10° p. 138

Shower trays of cast marble in the 10° concept design

**Material:** cast mixture of dolomite and resin

**Production process:** casting

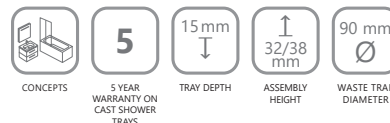

**Asymmetric Pro 10°**

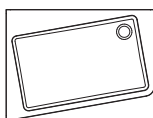

**Perseus Pro 10°**

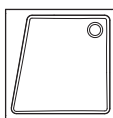

**Gigant Pro 10°**

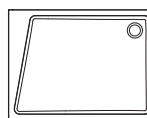

## Galaxy Pro Chrome p. 140

Shower trays of cast marble in the Chrome concept design

**Material:** cast mixture of dolomite and resin

**Production process:** casting

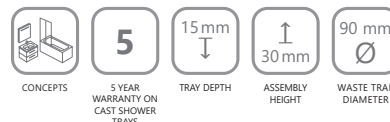

**Elipso Pro Chrome**

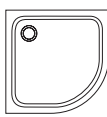

**Perseus Pro Chrome**

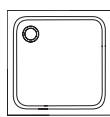

**Gigant Pro Chrome**

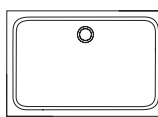

## Galaxy Pro p. 142

Cast shower trays with a slip-resistant surface

**Material:** cast mixture of dolomite and resin

**Production process:** casting



**Elipso Pro**

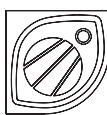

**Perseus Pro**



**Gigant Pro**

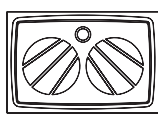

## Galaxy Pro Flat p. 144

Cast marble trays with smooth bottom

**Material:** cast mixture of dolomite and resin

**Production process:** casting



**Elipso Pro Flat**

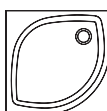

**Perseus Pro Flat**

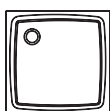

**Gigant Pro Flat**

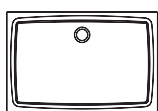

## Sabine Deep Seating Shower Tray p. 146

Acrylic shower tray with features of a bath

**Material:** Acrylic (PMMA + ABS sandwich), Antibac® finish

**Reinforcement:** LA type - fibreglass



**Sabina**

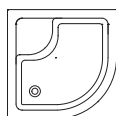

## Galaxy p. 148

Flat acrylic shower trays in modern design

**Material:** Acrylic (PMMA + ABS sandwich), Antibac® finish

**Reinforcement:** LA type - fibreglass types EX, PP, PAN - polyurethane foam with glass fibre



**Elipso**

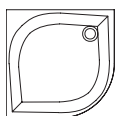

**Perseus**

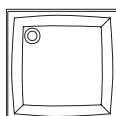

**Gigant**

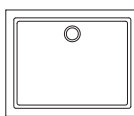

## Kaskada p. 150

Acrylic shower trays proven by customers' experience at a reasonable price

**Material:** Acrylic (PMMA + ABS sandwich), Antibac® finish

**Reinforcement:** LA type - fibreglass types EX, PU - polyurethane foam with glass fibre



**Ronda**

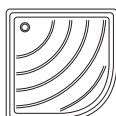

**Angela**



**Aneta**

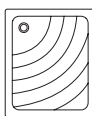



# Shower Trays Galaxy Pro 10°

Low and smooth shower trays of cast marble

5 year warranty for shower trays of cast marble



## Linked to the concept

The design of the trays matches 10° shower trays and other equipment for the entire bathroom.

## Extra flat design

Low and smooth bottom makes the maintenance of the shower tray much easier.

## Useful Asymmetry

Unique tray solution for creating an asymmetrical shower enclosure from the 10° concept. The slanted corner of the shower enclosure makes movement in the bathroom easier, while on the inside, the tray offers new, practical storage areas for cosmetics.



Embedded into the floor



Glued directly onto the floor

## Asymmetric Pro 10° 120 x 90/70



## Perseus Pro 10° 80, 90, 100



## Gigant Pro 10° 100 x 80, 120 x 90



Order No.	Shower tray type Galaxy Pro 10°
XA25G70101L	ASYMETRIC PRO 120x90 L 10° white
XA25G70101P	ASYMETRIC PRO 120x90 R 10° white
Order No.	SET (panel + panelkit)
XA95G70101L	Frontal panel ASYMETRIC PRO 120x90 SET L 10° white
XA95G70101P	Frontal panel ASYMETRIC PRO 120x90 SET R 10° white
Order No.	BASE (support legs)
XB2J000000N	GALAXY PRO Base

Order No.	Shower tray type Galaxy Pro 10°
XA054401010	PERSEUS PRO-80 10° white
XA057701010	PERSEUS PRO-90 10° white
XA05AA01010	PERSEUS PRO-100 10° white
Order No.	SET (panel + panelkit)
XA834001010	Frontal panel PERSEUS PRO-80 SET white
XA837001010	Frontal panel PERSEUS PRO-90 SET white
XA83A001010	Frontal panel PERSEUS PRO-100 SET white
Order No.	BASE (support legs)
XB2J000000N	GALAXY PRO Base

Order No.	Shower tray type Galaxy Pro 10°
XA05A40101L	GIGANT PRO 100x80 L 10° white
XA05A40101P	GIGANT PRO 100x80 R 10° white
XA05G70101L	GIGANT PRO 120x90 L 10° white
XA05G70101P	GIGANT PRO 120x90 R 10° white
Order No.	SET (panel + panelkit)
XA83AL01010	Frontal panel GIGANT PRO 100x80SET L white
XA83AP01010	Frontal panel GIGANT PRO 100x80 SET R white
XA83GL71010	Frontal panel GIGANT PRO 120x90 SET L white
XA83GP71010	Frontal panel GIGANT PRO 120x90 SET R white
Order No.	BASE (support legs)
XB2J000000N	GALAXY PRO Base



### Panel options:



L - left-hand sided variant of the product, R - right-hand sided variant of the product



To install a shower tray, we recommend using the universal mounting kit that will make the sealing of the tray easier.

► see p. 155

# Shower Trays Galaxy Pro Chrome

Low and smooth shower trays of cast marble

5 year warranty for shower trays of cast marble



SMOOTH  
BOTTOM

Easy maintenance thanks to the smooth bottom of the shower tray

## Linked to the concept

The shower tray bottom reflects the characteristic feature of the Chrome range - an oval shape in a form of rounded corners.

## Extra flat design

Low and smooth bottom makes the maintenance of the shower tray much easier.

## Easy-access solution

With their thickness of 30 mm, these shower trays are ideal for walk-in access achieved by embedding them into the floor.



Embedded into the floor

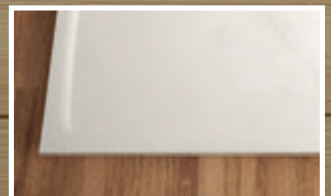

Glued directly onto the floor



## Elipso Pro Chrome 80, 90



## Perseus Pro Chrome 80, 90, 100



## Gigant Pro Chrome 100 x 80, 110 x 80, 120 x 80, 120 x 90



Order No.	Shower tray type Galaxy Pro Chrome
XA244401010	ELIPSO PRO-80 CHROME white
XA247701010	ELIPSO PRO-90 CHROME white
Order No.	SET (panel + panelkit)
XA934001010	Frontal panel ELIPSO PRO-80 SET white
XA937001010	Frontal panel ELIPSO PRO 90 white
Order No.	BASE (support legs)
XB2J000000N	GALAXY PRO Base

Order No.	Shower tray type Galaxy Pro Chrome
XA044401010	PERSEUS PRO-80 CHROME white
XA047701010	PERSEUS PRO-90 CHROME white
XA04AA01010	PERSEUS PRO-100 CHROME white
Order No.	SET (panel + panelkit)
XA834001010	Frontal panel PERSEUS PRO-80 SET white
XA837001010	Frontal panel PERSEUS PRO-90 SET white
XA83A001010	Frontal panel PERSEUS PRO-100 SET white
Order No.	BASE (support legs)
XB2J000000N	GALAXY PRO Base

Order No.	Shower tray type Galaxy Pro Chrome
XA04A401010	GIGANT PRO 100x80 CHROME white
XA04D401010	GIGANT PRO 110x80 CHROME white
XA04G401010	GIGANT PRO 120x80 CHROME white
XA04G701010	GIGANT PRO 120x90 CHROME white
Order No.	SET (panel + panelkit)
XA83AL01010	Frontal panel GIGANT PRO 100x80SET L white
XA83AP01010	Frontal panel GIGANT PRO 100x80 SET R white
XA83DL01010	Frontal panel GIGANT PRO 110x80 SET L white
XA83DP01010	Frontal panel GIGANT PRO 110x80 SET R white
XA83GL01010	Frontal panel GIGANT PRO 120x80 SET L white
XA83GP01010	Frontal panel GIGANT PRO 120x80 SET R white
XA83GL71010	Frontal panel GIGANT PRO 120x90 SET L white
XA83GP71010	Frontal panel GIGANT PRO 120x90 SET R white
Order No.	BASE (support legs)
XB2J000000N	GALAXY PRO Base



### Panel options:



L - left-hand sided variant of the product, R - right-hand sided variant of the product

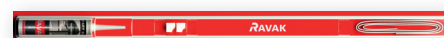

To install a shower tray, we recommend using the universal mounting kit that will make the sealing of the tray easier.

▶ see p. 155

Products are as standard delivered within 14 days.  
Galaxy Pro Chrome shower trays come without the base and the front covering panel. Galaxy Pro base includes support legs (5 pcs) and is suitable for all types of Galaxy Pro Chrome shower trays.  
The radius of the quarter-circle shower trays is R500\*.

# Shower Trays Galaxy Pro

Cast shower trays with a slip-resistant surface

5 year warranty for shower trays of cast marble



## Slip-resistant surface

The slip-resistant surface finish increases safety while showering.

## Extra flat design

Very durable shower trays made of cast marble of extra flat design suited for modern shower enclosures.

## Easy-access solution

With their thickness of 30 mm, these shower trays are ideal for walk-in access achieved by embedding them into the floor.



Embedded into the floor



Glued directly onto the floor

## Elipso Pro 80, 90, 100



## Perseus Pro 80, 90, 100



## Gigant Pro 100 x 80, 110 x 80, 120 x 80, 120 x 90



Order No.	Shower tray type Galaxy Pro
XA234401010	ELIPSO PRO-80 white
XA237701010	ELIPSO PRO-90 white
XA23AA01010	ELIPSO PRO-100 white
Order No.	SET (panel + panelkit)
XA934001010	Frontal panel ELIPSO PRO-80 SET white
XA937001010	Frontal panel ELIPSO PRO 90 white
XA93A001010	Frontal panel ELIPSO PRO 100 white
Order No.	BASE (support legs)
XB2J000000N	GALAXY PRO Base

Order No.	Shower tray type Galaxy Pro
XA034401010	PERSEUS PRO-80 white
XA037701010	PERSEUS PRO-90 white
XA03AA01010	PERSEUS PRO-100 white
Order No.	SET (panel + panelkit)
XA834001010	Frontal panel PERSEUS PRO-80 SET white
XA837001010	Frontal panel PERSEUS PRO-90 SET white
XA83A001010	Frontal panel PERSEUS PRO-100 SET white
Order No.	BASE (support legs)
XB2J000000N	GALAXY PRO Base

Order No.	Shower tray type Galaxy Pro
XA03A401010	GIGANT PRO 100x80 white
XA03D401010	GIGANT PRO 110x80 white
XA03G401010	GIGANT PRO 120x80 white
XA03G701010	GIGANT PRO 120x90 white
Order No.	SET (panel + panelkit)
XA83AL01010	Frontal panel GIGANT PRO 100x80SET L white
XA83AP01010	Frontal panel GIGANT PRO 100x80 SET R white
XA83DL01010	Frontal panel GIGANT PRO 110x80 SET L white
XA83DP01010	Frontal panel GIGANT PRO 110x80 SET R white
XA83GL01010	Frontal panel GIGANT PRO 120x80 SET L white
XA83GP01010	Frontal panel GIGANT PRO 120x80 SET R white
XA83GL71010	Frontal panel GIGANT PRO 120x90 SET L white
XA83GP71010	Frontal panel GIGANT PRO 120x90 SET R white
Order No.	BASE (support legs)
XB2J000000N	GALAXY PRO Base



### Panel options:



L - left-hand sided variant of the product, R - right-hand sided variant of the product



To install a shower tray, we recommend using the universal mounting kit that will make the sealing of the tray easier.

► see p. 155

Products are as standard delivered within 14 days.

Galaxy Pro shower trays come without the support legs and the front covering panel. Galaxy Pro base includes the support legs (5 pcs) and is the same for all types of Galaxy Pro shower trays. The radius of the quarter-circle shower trays is R500\*.



# Shower Trays Galaxy Pro Flat

Cast shower trays suited for modern bathrooms

5 year warranty for shower trays of cast marble



SMOOTH  
BOTTOM

Easy maintenance thanks to the smooth bottom of the shower tray

## Smooth bottom

Smooth bottom makes maintenance of the tray easier.

## Extra flat design

Very durable shower trays made of cast marble of extra flat design suited for modern shower enclosures.

## Easy-access solution

With their thickness of 30 mm, these shower trays are ideal for walk-in access achieved by embedding them into the floor.



Embedded into the floor



Glued directly onto the floor

## Elipso Pro Flat 80, 90



## Perseus Pro Flat 80, 90



## Gigant Pro Flat 100x80, 120x80, 120x90



Order No.	Shower tray type Galaxy Pro Flat
XA234411010	ELIPSO PRO-80 Flat white
XA237711010	ELIPSO PRO-90 Flat white
Order No.	SET (panel + panelkit)
XA934001010	Frontal panel ELIPSO PRO-80 SET white
XA937001010	Frontal panel ELIPSO PRO 90 white
Order No.	BASE (support legs)
XB2J000000N	GALAXY PRO Base

Order No.	Shower tray type Galaxy Pro Flat
XA034411010	PERSEUS PRO-80 Flat white
XA037711010	PERSEUS PRO-90 Flat white
Order No.	SET (panel + panelkit)
XA834001010	Frontal panel PERSEUS PRO-80 SET white
XA837001010	Frontal panel PERSEUS PRO-90 SET white
Order No.	BASE (support legs)
XB2J000000N	GALAXY PRO Base

Order No.	Shower tray type Galaxy Pro Flat
XA03A411010	GIGANT PRO 100x80 Flat white
XA03G411010	GIGANT PRO 120x80 Flat white
XA03G711010	GIGANT PRO 120x90 Flat white
Order No.	SET (panel + panelkit)
XA83AL01010	Frontal panel GIGANT PRO 100x80SET L white
XA83AP01010	Frontal panel GIGANT PRO 100x80 SET R white
XA83GL01010	Frontal panel GIGANT PRO 120x80 SET L white
XA83GP01010	Frontal panel GIGANT PRO 120x80 SET R white
XA83GL71010	Frontal panel GIGANT PRO 120x90 SET L white
XA83GP71010	Frontal panel GIGANT PRO 120x90 SET R white
Order No.	BASE (support legs)
XB2J000000N	GALAXY PRO Base

### Panel options:



L - left-hand sided variant of the product, R - right-hand sided variant of the product



To install a shower tray, we recommend using the universal mounting kit that will make the sealing of the tray easier.

▶ see p. 155

Products are as standard delivered within 14 days.  
Galaxy Pro Flat shower trays come without support legs and the front covering panel. Galaxy Pro base includes support legs (5 pcs) and the base is the same for all types of Galaxy Pro Flat shower trays.  
The radius of the quarter-circle shower trays is R500°.

# Deep Seating Shower Tray Sabina

When a classic bath doesn't fit



## Is a bath too big for your bathroom?

Do your kids love having baths more than anything? Sabina deep seating shower tray is designed for small bathrooms, where it will provide a possibility of having a bath or comfortable sitting while showering. With its depth of 27 cm, it combines the benefits of a bath and a shower enclosure.

## Antibac

Special protection method against growth and multiplication of bacteria and yeasts.



**Sabina**  
80, 90



**TYPE LA designed for underpinning or embedding**



**TYPE LA + BASE LA shower tray with support legs designed for underpinning**



**TYPE LA + BASE + SET LA shower tray with support legs and a front covering panel**

Order No.	Shower tray type
A214001020	SABINA-80 LA snowwhite
A217001020	SABINA-90 LA snowwhite
Order No.	BASE (support legs)
B2C0000002	SABINA 80 Base
B2C0000001	SABINA 90 Base
Order No.	Panel
A914001020	Frontal panel SABINA 80 white
A917001020	Frontal panel SABINA 90 white
Order No.	Panelkit
B2E000001N	Panelkit SABINA 80
B2E000000N	Panelkit SABINA 90

It is necessary to use the panelkit to mount the panel.

**You can find the waste trap for the Sabina shower tray on page 153.**

**We recommend it for the BLCP4 Sabina shower enclosures with reduced height see p. 104. or SKCP4 Sabina see p. 112.**



Products are as standard delivered within 14 days.  
The radius of the quarter-circle shower trays is R500\*.

# Shower Trays Galaxy

Extra flat and simply beautiful



## Flat modern design

Extra flat acrylic shower tray will enhance the appearance of any shower enclosure.

## Antibac

Special protection method against growth and multiplication of bacteria and yeasts.

**Elipso**  
80, 90, 100



LA

**Perseus**  
80, 90, 100

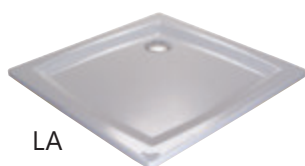

LA

**Gigant**  
100x80, 120x90



LA

**TYPE LA for installation on a base, or for embedding**



EX

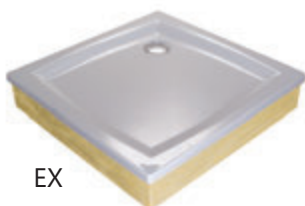

EX

**TYPE EX self-supporting tray without a front covering panel intended for encasing**



PAN

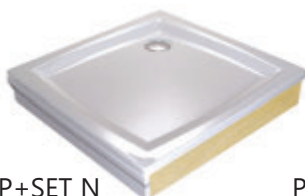

PP+SET N



PP+SET L

**TYPE PAN self-supporting tray, front covering panel included**

**TYPE PP+SET N self-supporting tray + front panel designed into a niche (front covering panel not included in the price)**

**TYPE PP+SET L self-supporting tray + front and side panels (front covering panel not included in the price)**

Order No.	Shower tray type Galaxy
A224401210	ELIPSO-80 LA white
A224401310	ELIPSO-80 EX white
A224401410	ELIPSO-80 PAN white
A227701210	ELIPSO-90 LA white
A227701310	ELIPSO-90 EX white
A227701410	ELIPSO-90 PAN white
A22AA01210	ELIPSO-100 LA white
A22AA01310	ELIPSO-100 EX white
A22AA01410	ELIPSO-100 PAN white
Order No.	BASE (support legs) for the type LA
B2F0000001	Universal Base 600 for LA-80
B2F0000002	Universal Base 650 for LA-90
B2F0000003	Universal Base 750 for LA-100

Order No.	Shower tray type Galaxy
A024401210	PERSEUS-80 LA white
A024401310	PERSEUS-80 EX white
A024401510	PERSEUS-80 PP white
A027701210	PERSEUS-90 LA white
A027701310	PERSEUS-90 EX white
A027701510	PERSEUS-90 PP white
A02AA01210	PERSEUS-100 LA white
A02AA01310	PERSEUS-100 EX white
A02AA01510	PERSEUS-100 PP white

Order No.	SET (panel + panelkit)
A824001010	Frontal panel PERSEUS-80 SET N white
A824401010	Frontal panel PERSEUS-80 SET L white
A827001010	Frontal panel PERSEUS-90 SET N white
A827701010	Frontal panel PERSEUS-90 SET L white
A82A001010	Frontal panel PERSEUS-100 SET N white
A82AA01010	Frontal panel PERSEUS-100 SET L white

Order No.	BASE (support legs) for the type LA
B2F0000001	Universal Base 600 for LA-80
B2F0000002	Universal Base 650 for LA-90
B2F0000003	Universal Base 750 for LA-100

Order No.	Shower tray type Galaxy
XA01A401210	GIGANT-100x80 LA white
XA01G701210	GIGANT-120x90 LA white
Order No.	BASE (support legs) for the type LA
B2F0000002	Universal Base 650 for LA-90
B2F0000003	Universal Base 750 for LA-100

**Design of front cover panels for the Perseus PP shower tray**



SET N:  
It is an option for niche

SET L:  
It is an option for corner



**To install a shower tray, we recommend using the universal mounting kit that will make the sealing of the tray easier.**

► see p. 155

Products are as standard delivered within 14 days.  
The Elipso and Perseus shower trays are 5 cm deep. The Gigant shower tray is 2.3 cm deep.  
The radius of the quarter-circle shower trays is R500".



# Shower Trays Kaskada

Trays for everyone - reliable and good value products



## Deeper shower tray

Depth of the shower tray is approximately 9 cm for comfortable showering.

Tray bottom features a characteristic cascade surface.

## Antibac

Special protection method against growth and multiplication of bacteria and yeasts.

## Versatile use

These acrylic shower trays can be installed on a base or directly onto the floor, or embedded into the floor.

The EX type is suited for encasing.

**Ronda**  
80, 90



LA

**TYPE LA for installation on a base, or for embedding**



EX

**TYPE EX self-supporting tray without a front covering panel intended for encasing**



PU

**TYPE PU with an integrated front covering panel**

**Angela**  
80, 90

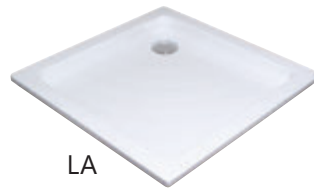

LA



EX

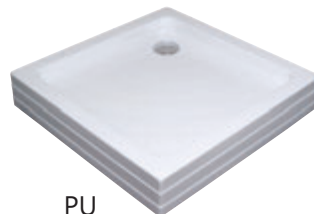

PU

**Aneta**  
75 x 90



LA



EX

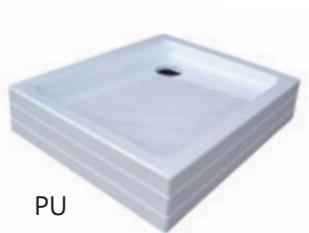

PU

Order No.	Shower tray type Kaskada
A204001120	RONDA-80 PU-R white
A204001320	RONDA-80 EX-R white
A207001120	RONDA-90 PU-R white
A207001320	RONDA-90 EX-R white
A214001220	RONDA-80 LA-R white
A217001220	RONDA-90 LA-R white
Order No.	BASE (support legs) for the type LA
B2F0000001	Universal Base 600 for LA-80
B2F0000002	Universal Base 650 for LA-90

Order No.	Shower tray type Kaskada
A004401120	ANGELA-80 PU-R white
A004401320	ANGELA-80 EX-R white
A007701120	ANGELA-90 PU-R white
A007701320	ANGELA-90 EX-R white
A014401220	ANGELA-80 LA-R white
A017701220	ANGELA-90 LA-R white
Order No.	BASE (support legs) for the type LA
B2F0000001	Universal Base 600 for LA-80
B2F0000002	Universal Base 650 for LA-90

Order No.	Shower tray type Kaskada
A003701120	ANETA 75x90 PU-R white
A003701220	ANETA 75x90 LA-R white
A003701320	ANETA 75x90 EX-R white
Order No.	BASE (support legs) for the type LA
B2F0000002	Universal Base 650 for LA-90



To install a shower tray, we recommend using the universal mounting kit that will make the sealing of the tray easier.

► see p. 155

Products are as standard delivered within 14 days.  
The radius of the quarter-circle shower trays is R500\*.

# Accessories for Shower Trays

## Shower tray waste traps

### **High flow**

The waste trap diameter is 90mm, ensuring an outflow of at least 30 litres of water per minute.

### **Easy to clean**

All shower tray traps can be cleaned from the above after removing the cap which makes them suitable for "fixed" installed shower trays.

### **Options**

Differences between the traps consist in different kinds of material used for the trap cover and its shape.



### Basic

3

3 YEAR WARRANTY FOR TRAP



A shower tray waste trap with a stainless steel cover  
Order No. X01308

### Standard

3

3 YEAR WARRANTY FOR TRAP



A shower tray waste trap with a metal plated plastic cover  
Order No. X01314

### Professional

3

3 YEAR WARRANTY FOR TRAP



A shower tray waste trap with a metal cover  
Order No. X01309

### Waste trap Sabina

3

3 YEAR WARRANTY FOR TRAP



Intended for the Sabina shower trays that have 52 mm Ø waste trap and overflow openings.

Water outflow is controlled using the ClickClack system (the trap is closed by pressing the cover and opened by another pressing).

Order No. X01315

### Waste trap adaptor 40/50



Reduces dimension differences between the drain pipe and waste trap.

Order No. X01304

### Sanitary silicone RAVAK Professional - 310 ml

Thanks to its own custom recipe developed over years of testing, RAVAK can offer its customers silicone capable of permanently joining together the diverse materials used in shower enclosure, shower tray and bathtub production. RAVAK silicone is capable of adhering to glass, acrylic, extruded polyester, aluminium, paint and various tiling materials.

RAVAK Professional sanitary silicone comes in two colours – white and clear.

Order No. X01200 / X01201

**Using the RAVAK Professional silicone is essential for sealing your shower enclosure, bath or shower tray properly.**

It takes the entire 310ml tube of silicone to fully fix and seal a shower tray.



# Cover strips



## Cover strips

Used to seal the gap between the wall and the shower tray. They optimally cover and seal the gap so that cleaning is much easier than in the case of an unevenly applied sealant which spoils the look of the whole work when dirt settles on it.

Cover strips can be purchased in the lengths of 1100 and 2000mm and types of 6, 10 or 11 mm. They are suitable for all types of shower trays.

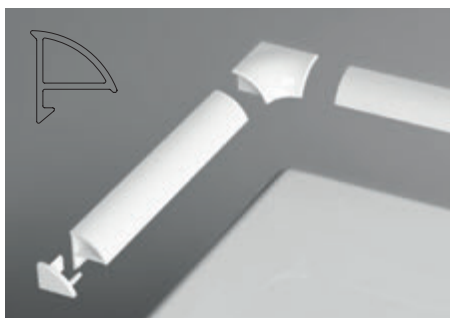

### Cover strip 6

- seals gaps up to 6 mm
- can be supplied with a set containing 2 cover strip end pieces (L,R) and 2 corner connectors

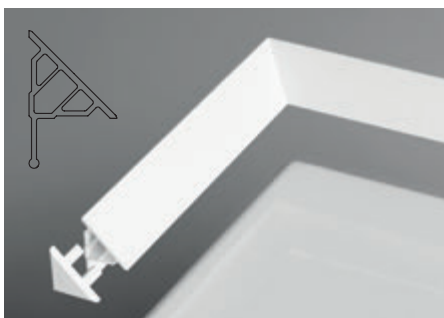

### Cover strip 10

- seals gaps up to 10 mm
- can be supplied with an end piece
- cut at 45 degrees to create a corner

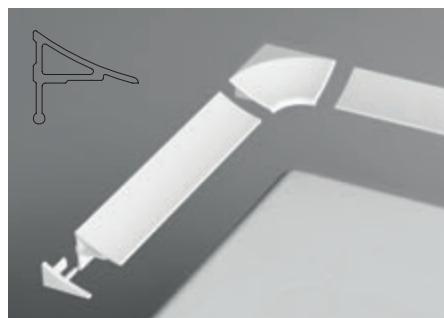

### Cover strip 11

- seals gaps up to 11 mm
- can be supplied with a set containing 2 cover strip end pieces (L,R) and 2 corner connectors

Order No.	Cover strips
XB441100001	Cover strip 6/1100 white
XB442000001	Cover strip 6/2000 white
B440000001	Set for the cover strip 6

Order No.	Cover strips
XB451100001	Cover strip 10/1100 white
XB452000001	Cover strip 10/2000 white
XB430001001	Cover strip end piece 10 white

Order No.	Cover strips
XB461100001	Cover strip 11/1100 white
XB462000001	Cover strip 11/2000 white
B460000001	Set for the cover strip 11

## Recommended way of sealing a shower tray

Badly covered gap between the tray and the wall, which will boost the formation of mould and mildew, is really unnecessary. If you insert a cover strip into the joint between the shower tray and the wall, your work will be professional.

Cover strip

Sanitary silicone RAVAK

Self-adhesive strip

Shower Tray



## Universal mounting kit

The Universal Mounting Kit is used for perfect sealing of a shower tray when installed into an already finished and tiled shower enclosure. This way the shower tray can be perfectly connected to the bathroom walls - perfectly in both appearance and function.

### The kit includes:

RAVAK Professional white sanitary silicone, 310 ml  
2200 mm self-adhesive strip,  
2 cover strips /6/1200 mm  
2 corner connectors for cover strips  
Order No. A000000004



## Universal Base

Universal Base is suitable for all LA type shower trays (except for Sabina) and helps you to install the tray in perfect level. A shower tray that has been set and levelled on this support can easily be underpinned and tiled.

The Universal Base consists of two metal bearers (600, 650 or 750 mm long - according to dimensions of the tray) and four adjustable legs.



## Base Galaxy Pro

Cast shower trays - Galaxy Pro, Galaxy Pro 10°, Galaxy Pro Flat, and Galaxy Pro Chrome can be installed directly on the floor without legs.

If you want to install the tray onto the base, we recommend you to use the Galaxy Pro Base set containing 5 legs. The floor should be tiled before the work.



Order No.	Base (support legs) for shower trays
B2F0000001	Universal Base 600 under shower trays LA 80 cm + Aneta 75 x 90 LA
B2F0000002	Universal Base 650 under shower trays LA 90 cm
B2F0000003	Universal Base 750 under shower trays LA 100 cm
XB2J000000N	Base Galaxy Pro under shower trays Galaxy Pro



# Shower Channels and Floor Drains

Let the beauty of ceramic  
tiling shine

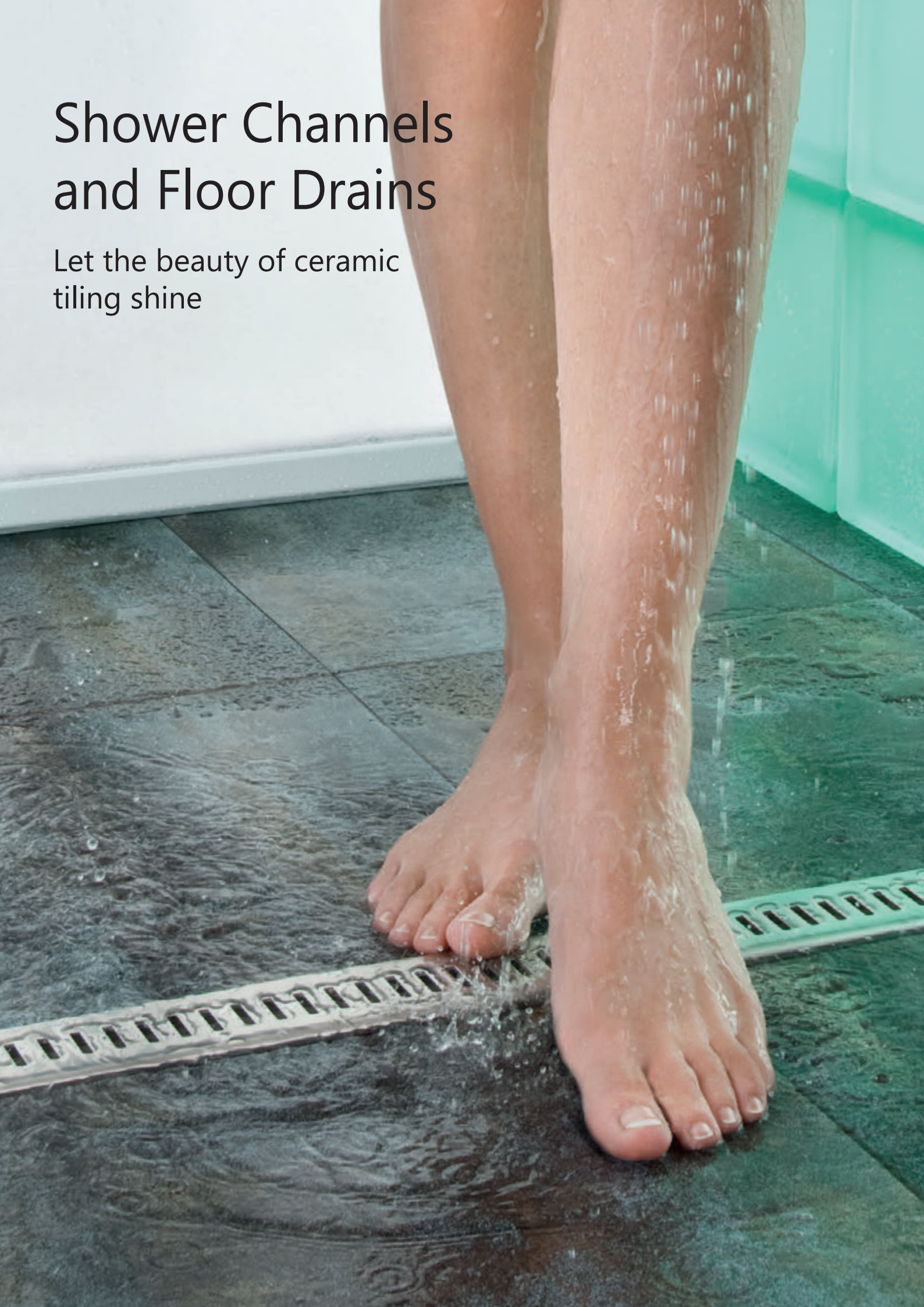



# Stainless shower channels - to the wall

## Chrome



Design Kryštof Nosál

## Runway



## 10°



Design Kryštof Nosál

- In three designs - **10°, Chrome, Runway**
- both the channel and the grate are made of high-quality stainless steel with a special finish to prevent dirt from clinging to the surface
- perfect and easy cleanability of the whole shower channel including the waste trap
- waste trap flow rate of 60 l/min guarantees safe drainage of any inflowing water
- double anti-odour seal
- height of the double anti-odour seal is 50 mm
- easy, fast and precise installation

Shower channels for installation close to the wall have a special "L profile" which allows you to use wall tiles of various thicknesses. Adjustable by up to 12 mm. You thus do not have your tile already picked out before buying the channel drain.



CONCEPTS 25 YEAR WARRANTY FOR CHANNEL DRAINS

Order No.	Type	Construction height (mm)	Minimum shower enclosure width (mm)
X01624	OZW RAVAK Chrome 750 - stainless	100	900
X01627	OZW RAVAK Chrome 850 - stainless		1000
X01630	OZW RAVAK Chrome 950 - stainless		1100
X01633	OZW RAVAK Chrome 1050 - stainless		1200
X01625	OZW RAVAK Runway 750 - stainless	100	900
X01628	OZW RAVAK Runway 850 - stainless		1000
X01631	OZW RAVAK Runway 950 - stainless		1100
X01634	OZW RAVAK Runway 1050 - stainless		1200
X01626	OZW RAVAK 10° 750 - stainless	100	900
X01629	OZW RAVAK 10° 850 - stainless		1000
X01632	OZW RAVAK 10° 950 - stainless		1100
X01635	OZW RAVAK 10° 1050 - stainless		1200

# Stainless shower channels - into the space

## Chrome



## Runway



## 10°

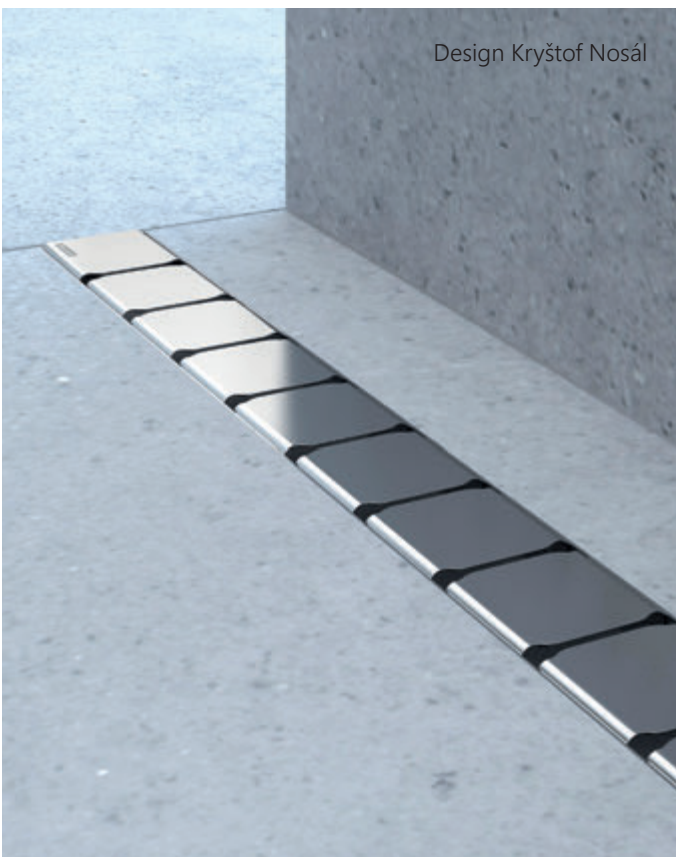

- In three designs - **10°, Chrome, Runway**
- both the channel and the grate are made of high-quality stainless steel with a special finish to prevent dirt from clinging to the surface
- perfect and easy cleanability of the whole shower channel including the waste trap
- waste trap flow rate of 60 l/min guarantees safe drainage of any inflowing water
- double anti-odour seal
- height of the double anti-odour seal is 50 mm
- easy, fast and precise installation

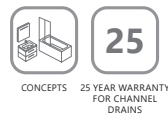

CONCEPTS 25 YEAR WARRANTY FOR CHANNEL DRAINS

Order No.	Type	Construction height (mm)	Minimum shower enclosure width (mm)
X01621	OZ RAVAK Chrome 750 - stainless		900
X01427	OZ RAVAK Chrome 850 - stainless	100	1000
X01428	OZ RAVAK Chrome 950 - stainless		1100
X01429	OZ RAVAK Chrome 1050 - stainless		1200
X01418	OZ RAVAK Runway 300 - stainless		-
X01622	OZ RAVAK Runway 750 - stainless		900
X01388	OZ RAVAK Runway 850 - stainless	100	1000
X01390	OZ RAVAK Runway 950 - stainless		1100
X01392	OZ RAVAK Runway 1050 - stainless		1200
X01623	OZ RAVAK 10° 750 - stainless		900
X01576	OZ RAVAK 10° 850 - stainless	100	1000
X01577	OZ RAVAK 10° 950 - stainless		1100
X01578	OZ RAVAK 10° 1000 - stainless		1200



## Zebra



## SN501

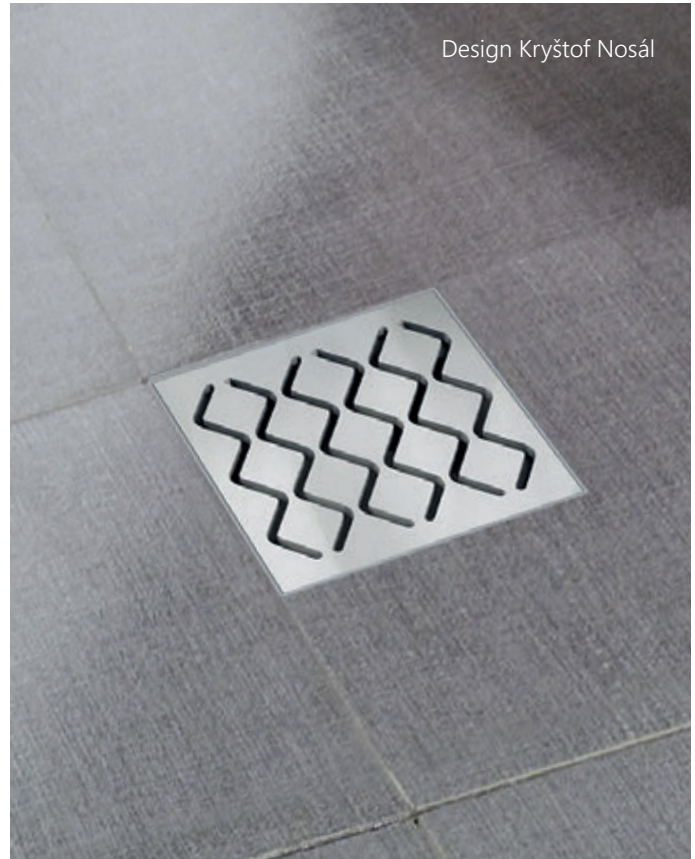

### Plastic shower channel with a stainless steel grid Zebra

- with low construction height, it is suitable for retrofits
- easy to clean down to the drain pipe
- flow rate 30 l/min with catchment drain
- combined anti-odour seal with the height of water column of 28 mm
- low construction height - 75 mm including tiles
- increased resistance of plastic against chemicals

### SN 501 plastic floor drain with stainless steel grid

- suitable for shower enclosures, bathrooms, and utility areas
- the grid is made of high-quality stainless steel machined with a water-jet cutter
- flow rate 37 l/min
- combined anti-odour seal with the height of water column of 30 mm
- stainless steel flange and an isolation level 2 collet

6/3\*

6/3\* YEAR WARRANTY ON PLASTIC CHANNEL DRAINS

Order No.	Type	Construction height (mm)	Minimum shower enclosure width (mm)
X01433	OZP RAVAK Zebra 750 - plastic	75	900
X01434	OZP RAVAK Zebra 850 - plastic	75	1000

6/3\*

6/3\* YEAR WARRANTY ON DRAINS

Order No.	Type	Minimum construction height (mm)
X01435	Floor drain Snake 105x105/50 - stainless	104
X01572	Self-adhesive waterproof membrane for a floor drain 300x300	-

When installing a shower channel or a floor drain, follow the instructions contained in document called Structural Preparedness which you can find in the Custom Shower Enclosures section at [www.ravak.com](http://www.ravak.com)

A high-angle photograph of a woman with her hair in a bun, relaxing in a white bathtub filled with white bubbles. She is looking down with a serene expression. The background is a plain, light-colored wall.

# Bathtubs

A combination of usefulness,  
beauty and uniqueness

Each of our bathtubs will offer you its story, motto or idea on which the model is based and the related added value.

The wide offer includes special small bathtubs suitable for confined space, asymmetrical bathtubs where you can also have comfortable shower, time-tested classic and freestanding bathtubs.

Most of these are part of complete bathroom solutions.

They can be equipped with both bath screens and bath doors to allow their use for showering as well. Therefore, by choosing the right bathtub with a screen you create a spacious shower at the same time.





# Bathtubs

A freestanding, rectangular or asymmetric bathtub, with large shelf space, a bathtub into a small bathroom or a bathtub for two?

**Ypsilon** 180 x 80 p. 166



**Solo** 178 x 80 p. 168



**Freedom O** 169 x 80 p. 170



**Freedom W** 166 x 80 p. 172



**City and City Slim** 180 x 80 p. 174 - 177



**Formy 01 and Formy 01 Slim** 180 x 80, 170 x 75 p. 178 - 181



**Formy 02 and Formy 02 Slim** 180 x 80 p. 182 - 185



**10°** 170 x 75 p. 186



**Campanula II** 180 x 80, 170 x 75 p. 188

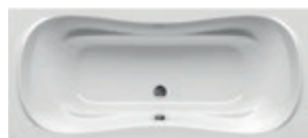

**Chrome and Chrome Slim** 170 x 75, 160 / 150 x 70 p. 190 - 193



**Classic** 170 / 160 / 150 / 140 / 120 x 70 p. 194



**Vanda II** 170 / 160 / 150 x 70 p. 196



**NewDay** 150 x 150, 140 x 140 p. 198



**Gentiana** 150 x 150, 140 x 140 p. 200



**LoveStory II** 196 x 139 p. 202



**10°** 170 x 100, 160 x 95 p. 204



**Chrome** 170 / 160 x 105 p. 206



**Rosa II** 170 / 160 / 150 x 105 p. 208



**Rosa 95** 160 / 150 x 95 p. 210



**Rosa I** 160 / 150 / 140 x 105 p. 212



**Avocado** 160 / 150 x 75 p. 214



**BeHappy II** 170 / 160 / 150 x 75 p. 216



**Asymmetric** 170 x 110, 160 x 105, 150 x 100 p. 218



# Why do bathtubs differ? Because their quality differs.



**Acrylic plate (PMMA)** No compromise on the material, we use the finest Lucite acrylic.



**Acrylic moulding**  
We use spot heating technology to guarantee optimum bathtub wall thickness in each location.



**Moulding reinforcement**  
Reinforcement of the moulding by resin with addition of fibreglass or polyurethane foam PU.



**Finished bathtub**  
A finished bathtub of the highest possible quality on the market.

## Why is the material used so important?

According to the manufacturing methods of acrylic sheets, currently the most common material in the manufacture of bathtubs, we can distinguish two basic types of acrylic - extruded and cast acrylic. Chemically, they are both the same material (polymethyl methacrylate - PMMA), but the different production methods cause significant differences in the utility qualities of this material. Extruded acrylic is produced by stretching, so its properties are preserved only in one direction. Sometimes, an even thinner layer of extruded acrylic is used together with the ABS plastic plate. Bathtubs made from this material exhibit the worst quality properties and after being built into the bathroom they may eventually crack.

Cast acrylic is poured into prepared moulds so the plate retains its physical properties in all directions. Cast acrylic is therefore a much better quality acrylic and it can guarantee that the product will maintain its desired shape in the long term and it will not sag or crack. This is why cast acrylic is more expensive than extruded acrylic.

**For these reasons, cast acrylic is the number one choice for RAVAK, which allows us to provide a ten-year warranty on bathtubs (more at [ravak.com](http://ravak.com)).**



## Reinforcement

**The most common reinforcement is made from polyester resin filled with fibreglass.**

When reinforcing with laminate, the acrylate moulding is sprayed with a mixture of resin and fibreglass. The ratio of these components and the amount of spray applicator is controlled by computer for each individual bathtub. The product with the sprayed layer then hardens in the tempering tunnel where strict process technology rules apply as well. The advantage of laminate is that it makes a very strong and tough product which is available at an affordable price.

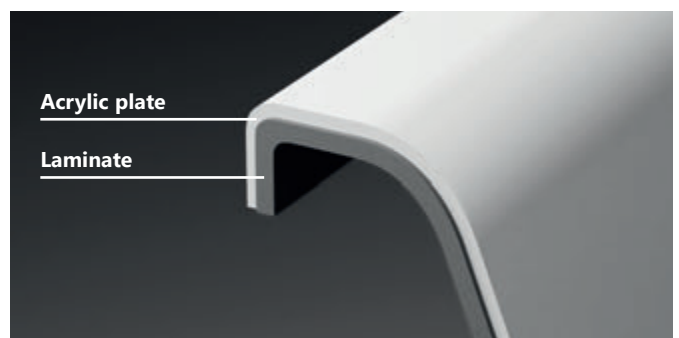





new

Design Kryštof Nosál

# Ypsilon

New Shape of Romance





**Soft geometry**

The designer softened the austere symmetry of shapes with a more delicate approach to the outlines to create a romantic whole. Through its simple shape, the bathtub adheres to the principles of modern design, while also providing a new dimension of comfort.

**Freedom and Comfort**

Gently widens up in the shoulder area to provide comfortable placement for the arms and relaxation for the neck and head. The comfort of lying in the Ypsilon bathtub combined with the effects of hot bathwater give the body a unique sensation of freedom.

270l	55 kg	10
VOLUME	WEIGHT	10 YEAR WARRANTY FOR BATHS

Order No.	BATHTUB
XC00100026	YPSILON 1800x800 snowwhite freestanding

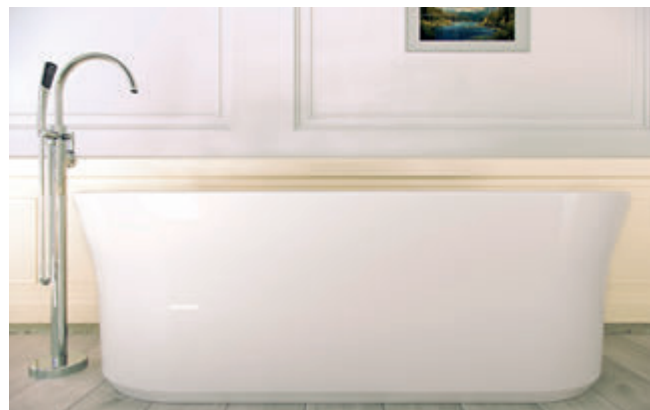

Freestanding bathtub faucet Freedom, see p. 383.

All water pipes must be laid in the floor (both water drain and water supply pipes for the floor faucet). Bathtub waste set (overflow, waste plug, waste trap) and supports (legs) included. The Ypsilon bathtub cannot be complemented by a bath screen. Products are as standard delivered within 14 days. For technical drawings of the bathtub, see p. 220.



Design Kryštof Nosál

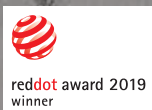

# Solo

Solo for clean shapes



### Unique design

Exceptional combination of two basic geometric shapes creates complete harmony. The rectangular base of the bathtub adds visual stability, the oval top increases the feeling of peace and relaxation.

### Natural solitaire

It attracts attention by minimalist expression and independence of space. Perfect for two people to meditate quietly.



For the Solo bathtub, we recommend the freestanding bathtub faucet see p. 383.

310l	67 kg	10
VOLUME	WEIGHT	10 YEAR WARRANTY FOR BATHS

Order No.	BATHTUB
XC00100025	SOLO 1780x800 snowwhite freestanding

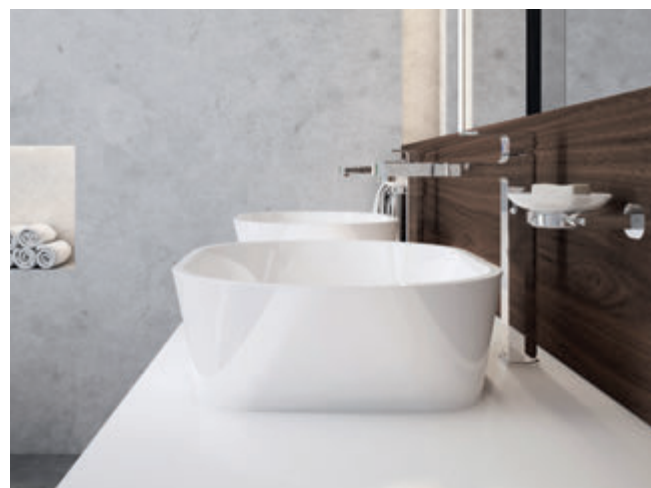

Washbasin Solo see p. 252.

All water pipes must be laid in the floor (both water drain and water supply pipes for the floor faucet). Bathtub waste set (overflow, waste plug, waste trap) and supports (legs) included. The Solo bathtub cannot be equipped with a bath screen. Products are as standard delivered within 14 days. For technical drawings of the bathtub, see p. 220.



# Freedom O

Freedom is a state of mind





### It's you who sets the rules

Place the bathtub wherever you like and when bathing choose the side of the bathtub where you have a better view. Do not limit yourself, just relax.

### Natural

Graceful curved lines without sharp edges and corners. Friendly oval shape of the bathtub embraces you and gives you a natural feeling of relaxation.



Order No.	<b>BATHTUB</b>
XC00100020	FREEDOM O 1690x800 snowwhite freestanding



Freestanding bathtub faucet  
FM 080.00

Freestanding Bathtub Faucets see p. 383.

All water pipes must be laid in the floor (both water drain and water supply pipes for the floor faucet).  
Bathtub waste set (overflow, waste plug, waste trap) and supports (legs) included.  
The Freedom O bathtub cannot be equipped with a bath screen.  
Products are as standard delivered within 14 days.  
For technical drawings of the bathtub, see p. 220.



# Freedom W

Delicate centrepiece of the bathroom



### Anchored in Open Space

The Freedom W bathtub embodies an optimal combination of the advantages of a freestanding bathtubs with classic bathtubs. Its delicate beauty and rounded curved shapes will entice you to lie down. The practical, wide edge along the wall will enable you to store everything you need within an arm's reach to truly enjoy your relaxation.

### Ready for Bathing

Looks perfect just the way it is. No need for panelling or any other modifications. Its rounded shape and ethereal, delicate front edge will stand out in any bathroom.

260l	45 kg	10
VOLUME	WEIGHT	10 YEAR WARRANTY FOR BATHS

For the Freedom W bathtub, we recommend the CR 025.00 waterfall bathtub filling faucet see p. 385.

Order No.	BATHTUB
XC00100024	FREEDOM W 1660x800 snowwhite freestanding



Bathtub waste set (overflow, waste plug, waste trap) and supports (legs) included.  
 The Freedom W bathtub cannot be complemented by a bath screen.  
 Products are as standard delivered within 14 days.  
 For technical drawings of the bathtub, see p. 220.



Design Kryštof Nosál

# City

Simply elegant





### Spacious

Comfortable, spacious, unobtrusive. All you need for a bathroom in a comfortable urban style.

### Naturally confident

It does not show off its uniqueness, but confidently waits for your attention to be inevitably drawn to it. And nothing will ever again distract you from the City bathtub. You will never get tired of its modesty, naturalness and elegant features.

220l	28 kg	10	5
VOLUME	WEIGHT	10 YEAR WARRANTY FOR BATHS	5-YEAR WARRANTY ON BATH PANELS

Panel colour finish:

Walnut	Satin wood	Oak	White
--------	------------	-----	-------

Order No.	<b>BATHTUB</b>
C920000000	CITY 180 x 80 snowwhite
Order No.	<b>SUPPORTS CITY</b>
CY00040000	Support for 80 U
Order No.	<b>PANELS CITY</b>
X000001059	Frontal panel 180 white
X000001060	Frontal panel 180 oak
X000001061	Frontal panel 180 walnut
X000001107	Frontal panel 180 satin wood
X000001062	Side panel 80 L white
X000001065	Side panel 80 R white
X000001063	Side panel 80 L oak
X000001066	Side panel 80 R oak
X000001064	Side panel 80 L walnut
X000001067	Side panel 80 R walnut
X000001108	Side panel 80 L satin wood
X000001109	Side panel 80 R satin wood



The City bathtub can be combined with the following panel designs: white, walnut, oak or satin wood.

The City bathtub can be complemented by a bath screen BVS1, BVS2, CVS2, PVS1 see p. 231.  
 We recommend combining the bathtub with an 800 mm bathtub waste set. see p. 227.  
 Products are as standard delivered within 14 days.  
 The warranty is contingent on the buyer using original RAVAK supports (legs) for the given type of bathtub in accordance with the assembly manual.  
 For technical drawings of the bathtub, see p. 220.

Design Kryštof Nosál

# City Slim

Simply elegant







## Bathtub with a rim only 18 mm tall

### Spacious

Comfortable, spacious, unobtrusive. All you need for a bathroom in a comfortable urban style.

### Naturally confident

It does not show off its uniqueness, but confidently waits for your attention to be inevitably drawn to it. And nothing will ever again distract you from the City bathtub. You will never get tired of its modesty, naturalness and elegant features.

220l	25 kg	10	5
VOLUME	WEIGHT	10 YEAR WARRANTY FOR BATHTUBS	5-YEAR WARRANTY ON BATH PANELS

Panel colour finish:

Walnut	Satin wood	Oak	White
--------	------------	-----	-------

Order No.	<b>BATHTUB</b>
C921300000	CITY SLIM 180 x 80 snowwhite
Order No.	<b>SUPPORTS CITY</b>
CY00040000	Support for 80 U
Order No.	<b>PANELS CITY SLIM</b>
X000001059	Frontal panel 180 white
X000001060	Frontal panel 180 oak
X000001061	Frontal panel 180 walnut
X000001107	Frontal panel 180 satin wood
X000001062	Side panel 80 L white
X000001065	Side panel 80 R white
X000001063	Side panel 80 L oak
X000001066	Side panel 80 R oak
X000001064	Side panel 80 L walnut
X000001067	Side panel 80 R walnut
X000001108	Side panel 80 L satin wood
X000001109	Side panel 80 R satin wood



The City Slim bathtub can be combined with the following panel designs: white, walnut, oak or satin wood.

The City Slim bathtub can be complemented by a bath screen BVS1, BVS2, CVS2, PVS1 see p. 231.  
 We recommend combining the bathtub with an 800 mm bathtub waste set. see p. 227.  
 Products are as standard delivered within 14 days.  
 The warranty is contingent on the buyer using original RAVAK supports (legs) for the given type of bathtub in accordance with the assembly manual.  
 For technical drawings of the bathtub, see p. 220.

Design Kryštof Nosál



# Formy 01

Minimalism in its purest form



### Shape that never gets old

Our designer transformed the usual symmetry of rectangular bathtubs by making one of the sides wider than the other, creating a puristically clean, yet remarkable-looking bathtub.

### With the option of customised final implementation

The visual design of the bathtub can be customised to fit the bathroom and the owner's personality. Covering panels in white are also available.

203l 240l	24 kg 29 kg		10	5
VOLUME	WEIGHT	CONCEPTS	10 YEAR WARRANTY FOR BATHS	5-YEAR WARRANTY ON BATH PANELS



Waterfall bathtub filling faucet CR 025.00 suitable for installation in the wider edge of the bathtub. For more information, see p. 385.

Order No.	<b>BATHTUB</b>
C691000000	FORMY 01 170 x 75 snowwhite
C881000000	FORMY 01 180 x 80 snowwhite
Order No.	<b>SUPPORTS + PANELS + PANELKITS</b>
CY00030000	Support for 75 U
CY00040000	Support for 80 U
CZ001V0A00	Frontal panel U 170 snowwhite
CZ001Y0A00	Frontal panel U 180 snowwhite
CZ00130A00	Side panel U 75 snowwhite
CZ00140A00	Side panel U 80 snowwhite
B23600000N	Frontal panelkit U



Washbasins Formy see p. 251.

The Formy 01 bathtub can be complemented by a bath screen BVS1, BVS2, CVS2 see p. 233. We recommend combining the bathtub with an 800 mm bathtub waste set. see p. 227. Products are as standard delivered within 14 days. The warranty is contingent on the buyer using original RAVAK supports (legs) for the given type of bathtub in accordance with the assembly manual. For technical drawings of the bathtub, see p. 221.



Design Kryštof Nosál

# Formy 01 Slim

Minimalism in its purest form



### Now also with a rim only 18 mm tall

### Shape that never gets old

Our designer transformed the usual symmetry of rectangular bathtubs by making one of the sides wider than the other, creating a puristically clean, yet remarkable-looking bathtub.

### With the option of customised final implementation

The visual design of the bathtub can be customised to fit the bathroom and the owner's personality. Covering panels in white are also available.

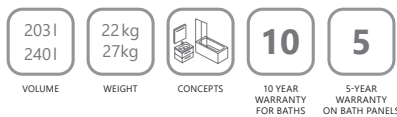

Order No.	<b>BATHTUB</b>
C691300000	FORMY 01 SLIM 170 x 75 snowwhite
C881300000	FORMY 01 SLIM 180 x 80 snowwhite
Order No.	<b>SUPPORTS + PANELS</b>
CY00030000	Support for 75 U
CY00040000	Support for 80 U
X000001059	Frontal panel 180 white
X000001062	Side panel 80 L white
X000001065	Side panel 80 R white



Bathroom Furniture Formy see p. 287.

The Formy 01 Slim bathtub can be complemented by a bath screen BVS1, BVS2, CVS2 see p. 233. We recommend combining the bathtub with an 800 mm bathtub waste set. see p. 227. Products are as standard delivered within 14 days. The warranty is contingent on the buyer using original RAVAK supports (legs) for the given type of bathtub in accordance with the assembly manual. For technical drawings of the bathtub, see p. 221.



Design Kryštof Nosál



# Formy 02

Slight curvature for new dynamics





### New design for a classic bathtub

The familiar rectangular bathtub shape was re-energised through slight curvature. The curved inner shape of the bathtub brings into the bathroom a pleasant atmosphere and greater enjoyment from bathing.

### With the option of customised final implementation

You can customise the visual design of the bathtub to fit your personality and your bathroom. Covering panels in white are also available.

240l	29 kg		10	5
VOLUME	WEIGHT	CONCEPTS	10 YEAR WARRANTY FOR BATHTHS	5-YEAR WARRANTY ON BATH PANELS

Order No.	<b>BATHTUB</b>
C891000000	FORMY 02 180 x 80 snowwhite
Order No.	<b>SUPPORTS + PANELS + PANELKITS</b>
CY00040000	Support for 80 U
CZ001Y0A00	Frontal panel U 180 snowwhite
CZ00140A00	Side panel U 80 snowwhite
B23600000N	Frontal panelkit U



Faucets for freestanding bathtubs and washbasins see p. 352.

The Formy 02 bathtub can be complemented by a bath screen CVS2, PVS1, BVS1, BVS2, see p. 230. We recommend combining the bathtub with an 800 mm bathtub waste set., see p. 227. Products are as standard delivered within 14 days. The warranty is contingent on the buyer using original RAVAK supports (legs) for the given type of bathtub in accordance with the assembly manual. For technical drawings of the bathtub, see p. 221.

Design Kryštof Nosál



# Formy 02 Slim

Slight curvature for new dynamics



## Now also with a rim only 18 mm tall

## New design for a classic bathtub

The familiar rectangular bathtub shape was re-energised through slight curvature. The curved inner shape of the bathtub brings into the bathroom a pleasant atmosphere and greater enjoyment from bathing.

## With the option of customised final implementation

You can customise the visual design of the bathtub to fit your personality and your bathroom. Covering panels in white are also available.

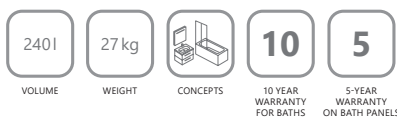

Order No.	<b>BATHTUB</b>
C891300000	FORMY 02 SLIM 180 x 80 snowwhite
Order No.	<b>SUPPORTS + PANELS</b>
CY00040000	Support for 80 U
X000001059	Frontal panel 180 white
X000001062	Side panel 80 L white
X000001065	Side panel 80 R white



Formy bathroom furniture, see p. 286.

The Formy 02 Slim bathtub can be complemented by a bath screen CVS2, PVS1, BVS1, BVS2, see p. 239. We recommend combining the bathtub with an 800 mm bathtub waste set. see p. 227. Products are as standard delivered within 14 days. The warranty is contingent on the buyer using original RAVAK supports (legs) for the given type of bathtub in accordance with the assembly manual. For technical drawings of the bathtub, see p. 221.



Design Kryštof Nosál

# 10°

Classic yet modern





## Practical and Spacious

Features a subtle look, yet is large and comfortable. The interior volume of the bathtub was maximised by its designer at the expense of its robust appearance. That resulted in a visually lightweight, practical bathtub that offers an excellent space for both bathing and showering.

## Additional Bathtub in the 10° Concept

Through its addition, the 10° concept offers bathing enthusiasts two different ways of fitting a bathtub into their bathroom. The revolutionary asymmetrical variant of the bathtub (see p. 204) will serve dutifully especially in smaller spaces, whereas the classic rectangular bathtub will fit perfectly into standard or larger bathrooms.



Order No.	<b>BATHTUB</b>
CA71000000	10° 170x75 snowwhite
Order No.	<b>SUPPORTS + PANELS + PANELKITS</b>
CY00030000	Support for 75 U
CZ001V0A00	Frontal panel U 170 snowwhite
CZ00130A00	Side panel U 75 snowwhite
B23600000N	Frontal panelkit U



The 10° bathtub can be complemented by a bath screen PVS1, CVS2, BVS1, BVS2, see p. 231.  
 Products are as standard delivered within 14 days.  
 The warranty is contingent on the buyer using original RAVAK supports (legs) for the given type of bathtub in accordance with the assembly manual.  
 For technical drawings of the bathtub, see p. 221.

Design Kryštof Nosál

# Campanula II

A modern concept of romance







### Acknowledged romance

In a flurry of pragmatically simple bathtubs, the Campanula II evokes a dream of romantic evenings in a scented bath by candlelight.

### More comfort

The outflow located in the centre allows a comfortable soak for one or two people.

2001 2201	23 kg 25 kg	<b>10</b>
VOLUME	WEIGHT	10 YEAR WARRANTY FOR BATHS

Order No.	<b>BATHTUB</b>
CA21000000	CAMPANULA II 170x75 snowwhite
CB21000000	CAMPANULA II 180x80 snowwhite
Order No.	<b>SUPPORTS + PANELS + PANELKITS</b>
CY00030000	Support for 75 U
CY00040000	Support for 80 U
CZ001V0A00	Frontal panel U 170 snowwhite
CZ001Y0A00	Frontal panel U 180 snowwhite
CZ00130A00	Side panel U 75 snowwhite
CZ00140A00	Side panel U 80 snowwhite
B23600000N	Frontal panelkit U



Campanula II bathtub with PVS1 bath screen. see p. 234.

Campanula bathtub can be complemented by a bath screen PVS1, CVS2, BVS1, BVS2, or bath door AVDP3 see p. 231.

Products are as standard delivered within 14 days.

The warranty is contingent on the buyer using original RAVAK supports (legs) for the given type of bathtub in accordance with the assembly manual.

For technical drawings of the bathtub, see p. 221.

Design Kryštof Nosál

# Chrome

Synergy of Design and Function





### Harmony of simple shapes

Chrome bathtub combines basic shapes to achieve maximum effect. An oval bottom is enveloped by a classic rectangular body providing synergy of design and practical features.

### Perfect design - Chrome concept

You can harmonise your bathroom to achieve a single design without having to laboriously collect each product separately. The bathtub is matched with the shower enclosure with a shower seat and shower tray or shower channel, washbasin with furniture, toilet and bidet, faucet, and bathroom accessories.

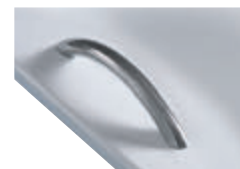

Universal stainless steel handle

185l 195l 225l	21 kg 23 kg 25 kg	CONCEPTS	10 10 YEAR WARRANTY FOR BATHS
VOLUME	WEIGHT		

Order No.	BATHTUB
C721000000	CHROME 150x70 snowwhite
C731000000	CHROME 160x70 snowwhite
C741000000	CHROME 170x75 snowwhite
Order No.	SUPPORTS + PANELS + PANELKITS + HANDLE
CY00000000	Support for 70 U
CY00030000	Support for 75 U
CZ72100A00	Frontal panel A for CHROME 150 snowwhite
CZ73100A00	Frontal panel A for CHROME 160 snoww
CZ74100A00	Frontal panel A for CHROME 170 snoww
CZ72110A00	Side panel A for CHROME 70 snowwhite
CZ74130A00	Side panel A for CHROME 75 snowwhite
B23600000N	Frontal panelkit U
B5C0000000	RAVAK Handle universal stainless



The Chrome bathtub can be complemented by a bath screen CVS2, VS2, VS3, VS5, PVS1, BVS1, BVS2, or bath door AVDP3 see p. 231.

Products are as standard delivered within 14 days.

The warranty is contingent on the buyer using original RAVAK supports (legs) for the given type of bathtub in accordance with the assembly manual. For technical drawings of the bathtub, see p. 221.



Design Kryštof Nosál



# Chrome Slim

Synergy of Design and Function



**Now also with a rim only 18 mm tall**

**Harmony of simple shapes**

Chrome bathtub combines basic shapes to achieve maximum effect. An oval bottom is enveloped by a classic rectangular body providing synergy of design and practical features.

**Perfect design - Chrome concept**

You can harmonise your bathroom to achieve a single design without having to laboriously collect each product separately. The bathtub is matched with the shower enclosure with a shower seat and shower tray or shower channel, washbasin with furniture, toilet and bidet, faucet, and bathroom accessories.

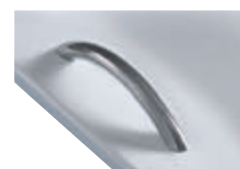

Universal stainless steel handle

185l 195l 225l	19 kg 21 kg 23 kg	 CONCEPTS	10
VOLUME	WEIGHT	CONCEPTS	10 YEAR WARRANTY FOR BATHS

Order No.	BATHTUB
C721300000	CHROME SLIM 150x70 snowwhite
C731300000	CHROME SLIM 160x70 snowwhite
C741300000	CHROME SLIM 170x75 snowwhite
Order No.	SUPPORT
CY00000000	Support for 70 U
CY00030000	Support for 75 U



Fine-tune your bathroom in matching design. Chrome sanitary ware, see p. 351.

The Chrome Slim bathtub can be complemented by a bath screen CVS2, VS2, VS3, VS5, PVS1, BVS1, BVS2, or bath door AVDP3 see p. 231.  
 Products are as standard delivered within 14 days.  
 The warranty is contingent on the buyer using original RAVAK supports (legs) for the given type of bathtub in accordance with the assembly manual.  
 For technical drawings of the bathtub, see p. 221.

Design Kryštof Nosál

# Classic

Simplicity is beauty







**Although only 70 cm wide, this bathtub provides comfortable bathing**

Bathing and showering made easy thanks to the safe flat bottom and a range of shower screens and doors.

**Generous inner space**

Subtle and elegant rims and sharper slope of the sides give the bathtub unusually large inner space for its small dimensions.

1251 / 1801 1951 / 2101 2251	18 / 20 20 / 22 24 (kg)	 CONCEPTS	10
VOLUME	WEIGHT	CONCEPTS	10 YEAR WARRANTY FOR BATHS



Universal stainless steel handle

Order No.	BATHTUB
C861000000	CLASSIC 120x70 snowwhite
CA81000000	CLASSIC 140x70 snowwhite
C521000000	CLASSIC 150x70 N snowwhite
C531000000	CLASSIC 160x70 N snowwhite
C541000000	CLASSIC 170x70 N snowwhite
Order No.	SUPPORTS + PANELS + PANELKITS + HANDLE
CY00000000	Support for 70 U
CZ001P0A00	Frontal panel U 150 snowwhite
CZ001S0A00	Frontal panel U 160 snowwhite
CZ001V0A00	Frontal panel U 170 snowwhite
CZ00110A00	Side panel U 70 snowwhite
B23600000N	Frontal panelkit U
B5C0000000	RAVAK Handle universal stainless



The 120 cm long mini-bathtub can substitute a shower enclosure. Thanks to its standard depth of 42 cm, typical for all bathtubs, it offers a comfortable bathing space for children, but can also be used to create a perfectly sealed spacious shower enclosure by adding bath door AVDP3 (see p. 236). Ideal solution for small bathrooms and niches.

The Classic bathtub can be complemented by a bath screen VS2, VS3, VS5, PVS1, BVS1, BVS2, CVS2 or bath door AVDP3 see p. 231.  
 Products are as standard delivered within 14 days.  
 The warranty is contingent on the buyer using original RAVAK supports (legs) for the given type of bathtub in accordance with the assembly manual.  
 For technical drawings of the bathtub, see p. 222.



# Vanda II

A popular bathtub with agile lines

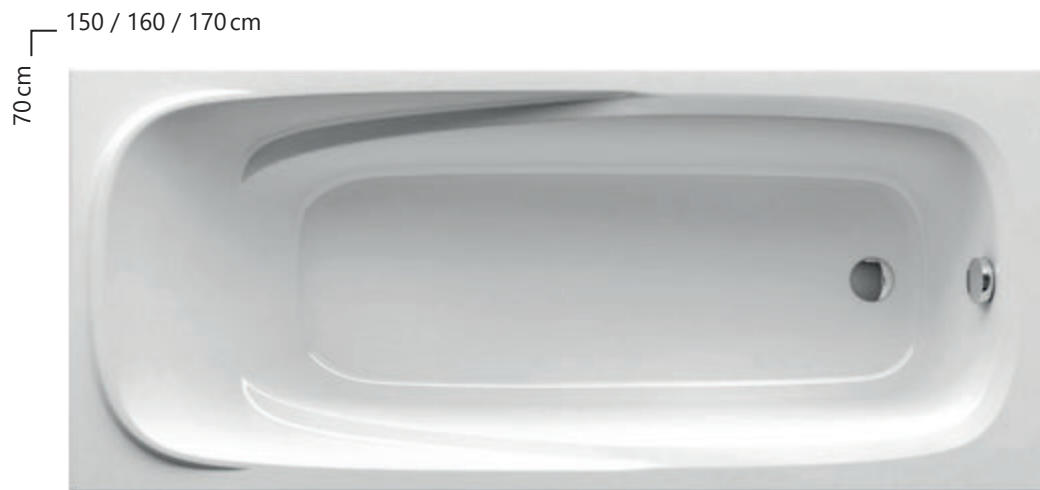

### If you know what is good for you

Popular bathtub Vanda is for people who know what they want. Defined by its shapes, it is ideal for those who like to read in the bath, or who will appreciate the fact that getting out is more comfortable.

### Several dimensional options

You can choose from three lengths which fit in every bathroom.

165l 180l 195l	22 kg 24 kg 24 kg	<b>10</b>
VOLUME	WEIGHT	10 YEAR WARRANTY FOR BATHS

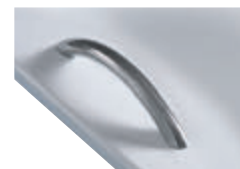

Universal stainless steel handle

Order No.	<b>BATHTUB</b>
CO11000000	VANDA II 150x70 snowwhite
CP11000000	VANDA II 160x70 snowwhite
CP21000000	VANDA II 170x70 snowwhite
Order No.	<b>SUPPORTS + PANELS + PANELKITS + HANDLE</b>
CY00000000	Support for 70 U
CZ001P0A00	Frontal panel U 150 snowwhite
CZ001S0A00	Frontal panel U 160 snowwhite
CZ001V0A00	Frontal panel U 170 snowwhite
CZ00110A00	Side panel U 70 snowwhite
B23600000N	Frontal panelkit U
B5C0000000	RAVAK Handle universal stainless



The Vanda bathtub can be complemented by a bath screen VS2, VS3, VS5, PVS1, CVS2, BVS1, BVS2, or bath door AVDP3 see p. 231.

Products are as standard delivered within 14 days.

The warranty is contingent on the buyer using original RAVAK supports (legs) for the given type of bathtub in accordance with the assembly manual.

For technical drawings of the bathtub, see p. 222.



Design Kryštof Nosál

# NewDay

Modern and clean lines for  
bathing for two

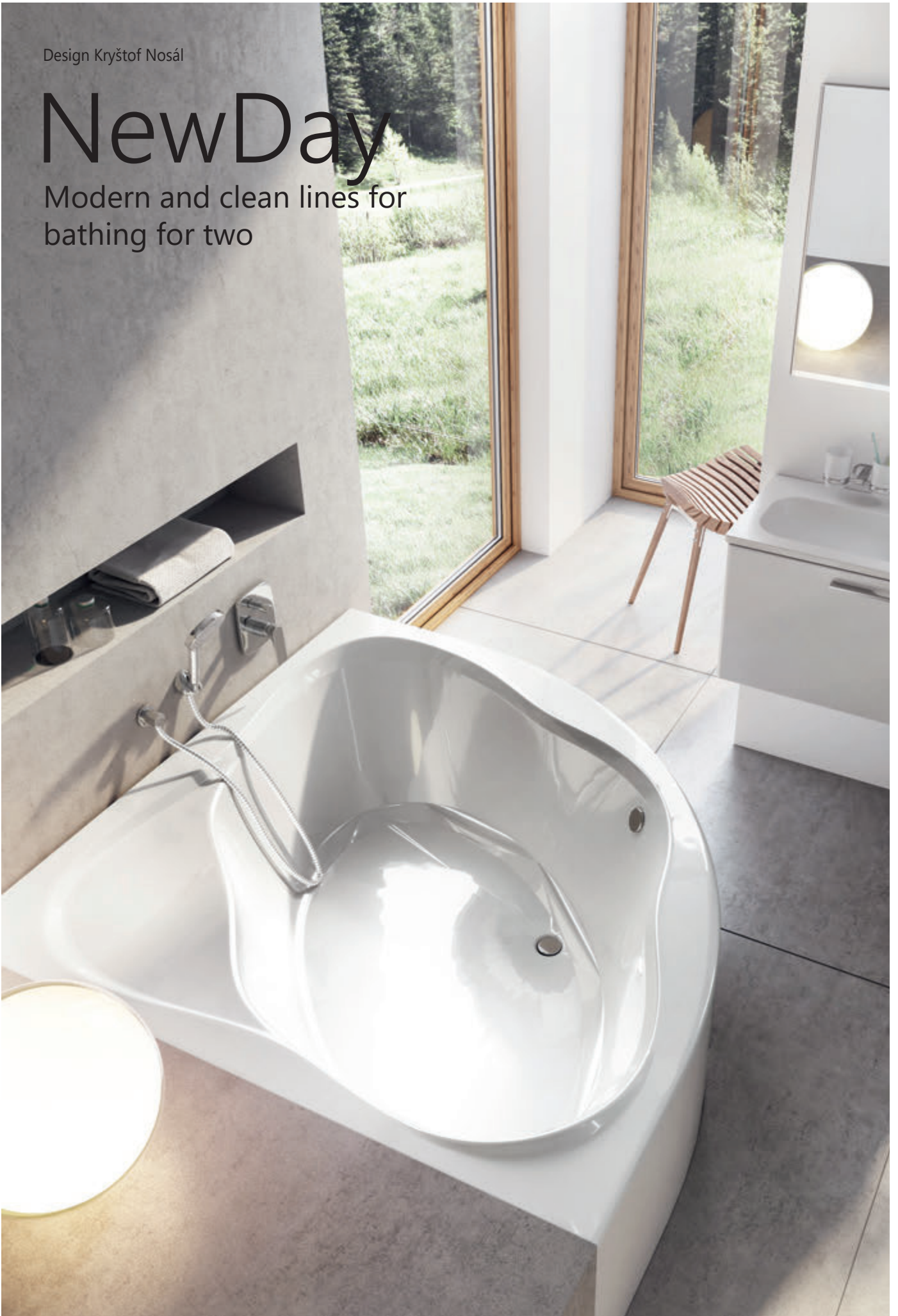



### Comfortable for two

Enjoy sensual bathing with your partner thanks to the gentle slope of the back side of the bathtub and the central location of the waste outflow.

### Shelf space

Wider bathtub rim and the seat above water level offer enough shelf space not only for the moments of relaxation.

2351 2951	29 kg 34 kg	10
VOLUME	WEIGHT	10 YEAR WARRANTY FOR BATHS

Order No.	BATHTUB
C651000000	NEW DAY 140x140 snowwhite
C661000000	NEW DAY 150x150 snowwhite
Order No.	SUPPORTS + PANELS + PANELKITS
CY65000000	Support for NEW DAY,GENTIANA
CZF1000ANO	Frontal panel for A GENTIANA, NEW DAY 140 cm snow
CZG1000ANO	Frontal panel for A GENTIANA, NEW DAY 150 cm snow
B26500000N	Panelkit NEW DAY,GENTIANA



The NewDay bathtub cannot be complemented by a bath screen.  
 Products are as standard delivered within 14 days.  
 The warranty is contingent on the buyer using original RAVAK supports (legs) for the given type of bathtub in accordance with the assembly manual.  
 For technical drawings of the bathtub, see p. 222.

# Gentiana

Comfort and space for two







### Perfect relaxation

A spacious and wide bathtub which guarantees the most comfortable bathing.

### Generous and useful

A seat above the water level will provide maximum comfort when bathing and showering.

240l 300l	31 kg 36 kg	10
VOLUME	WEIGHT	10 YEAR WARRANTY FOR BATHS

Order No.	<b>BATHTUB</b>
CF01000000	GENTIANA 140x140 snowwhite
CG01000000	GENTIANA 150x150 snowwhite
Order No.	<b>SUPPORTS + PANELS + PANELKITS</b>
CY65000000	Support for NEW DAY,GENTIANA
CZF1000A00	Frontal panel for A GENTIANA, NEW DAY 140 cm snow
CZG1000A00	Frontal panel for A GENTIANA, NEW DAY 150 cm snow
B26500000N	Panelkit NEW DAY,GENTIANA

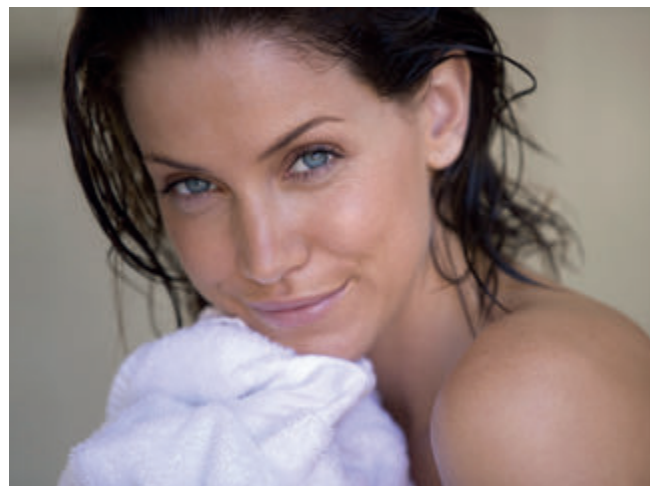

The Gentiana bathtub cannot be complemented by a bath screen.  
 Products are as standard delivered within 14 days.  
 The warranty is contingent on the buyer using original RAVAK supports (legs) for the given type of bathtub in accordance with the assembly manual.  
 For technical drawings of the bathtub, see p. 223.

Design Achim Storz

# LoveStory II

Love for lifetime



**Achim Storz**, author

"Design can be both emotional  
and clean in expression."



### For a real feeling of closeness

Allows you to share your experiences of bathing in two.

### Advantageous asymmetry

Asymmetrical position of the bathtub works with space to your benefit. You can fit a really large bathtub in the corner of your bathroom.

360l	38 kg	L/R	10
VOLUME	WEIGHT	L/R OPTION	10 YEAR WARRANTY FOR BATHS

Order No.	BATHTUB
C751000000	LOVE STORY II L snowwhite
C761000000	LOVE STORY II R snowwhite
Order No.	SUPPORTS + PANELS + PANELKITS
CY75000000	Support for LOVE STORY II
CZ75100A00	Frontal panel for A LOVE STORY II L snowwhite
CZ76100A00	Frontal panel for A LOVE STORY II R snowwhite
B27500000N	Panelkit LOVE STORY II



The LoveStory II bathtub cannot be complemented by a bath screen.

**L (left)** - Left-hand product option, **R (right)** - right-hand product option.

Products are as standard delivered within 14 days.

The warranty is contingent on the buyer using original RAVAK supports (legs) for the given type of bathtub in accordance with the assembly manual.

For technical drawings of the bathtub, see p. 223.



Design Kryštof Nosál

# 10°

A new perspective



reddot design award  
winner 2015



DESIGN  
AWARD  
2016



**Kryštof Nosál**, author

"For each product, I look for a simple idea with a distinctive charm."



### Clever use of slight rotation

Just a slight 10° rotation of a classic shape bathtub was enough to offer extra space which can be used as a shelf or seat.

### Screen for a wide shower enclosure

Combined with a bath screen, the bathtub 10° offers plenty of room in the showering space.

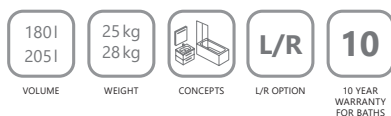

Order No.	BATHTUB
C831000000	10° 160x95 L snowwhite
C841000000	10° 160x95 R snowwhite
C811000000	10° 170x100 L snowwhite
C821000000	10° 170x100 P snowwhite
Order No.	SUPPORTS + PANELS + PANELKITS
CY81000000	Support for 10°
CZ83100A00	Frontal A panel 10° 160 L snowwhite
CZ84100A00	Frontal panel A for 10° 160 R snowwhite
CZ81100A00	Frontal panel A 10° 170 L snowwhite
CZ82100A00	Frontal panel A for 10° 170 P snowwhite
B28100000N	Panelkit 10°, BeHappy II, Chrome 160, 170 x 105



10° concept is suitable for larger and smaller bathrooms.

The 10° bathtub can be complemented by a bath screen 10CVS2 (see p. 239).

**L (left)** - Left-hand product option, **R (right)** - right-hand product option.

Products are as standard delivered within 14 days.

The warranty is contingent on the buyer using original RAVAK supports (legs) for the given type of bathtub in accordance with the assembly manual.

For technical drawings of the bathtub, see p. 223.

Design Kryštof Nosál

# Chrome

Attuned to harmony







### The Ideal Bathtub for the Gourmet Bather

Comfortable, with a view of the bathroom interior, equipped with storage areas. That is asymmetrical bathtub Chrome. Its sitting direction is slightly turned to provide its user as much comfort and enjoyment as possible. Why stare into a corner when you can enjoy a pleasant view of the design harmony of the individual elements of your bathroom.

### Asymmetrical Option for the Largest Concept on the Market

No need to make compromises. Choose a bathtub in the popular Chrome design regardless of whether your bathroom requires a classic rectangular shape or would benefit from the practical aspects of asymmetry.

Asymmetrical bathtub Chrome further expands the broad Chrome concept with its over 200 items for perfectly matched design of your bathroom.

<b>195 l</b> <b>225 l</b>	<b>25 kg</b> <b>27 kg</b>		<b>L/R</b>	<b>10</b>
VOLUME	WEIGHT	CONCEPTS	L/R OPTION	10 YEAR WARRANTY FOR BATHS

Order No.	BATHTUB
CA51000000	CHROME 160x105 L snowwhite
CA61000000	CHROME 160x105 R snowwhite
CA31000000	CHROME 170x105 L snowwhite
CA41000000	CHROME 170x105 R snowwhite
Order No.	SUPPORTS + PANELS + PANELKITS
CY81000000	Support for 10°
CZA5100A00	Frontal panel for CHROME 160x105 L snowwhite
CZA6100A00	Frontal panel for CHROME 160x105 R snowwhite
CZA3100A00	Frontal panel for CHROME 170x105 L snowwhite
CZA4100A00	Frontal panel for CHROME 170x105 R snowwhite
B28100000N	Panelkit 10°, BeHappy II, Chrome 160, 170 x 105



**L (left)** - Left-hand product option, **R (right)** - right-hand product option.  
 Products are as standard delivered within 14 days.  
 The warranty is contingent on the buyer using original RAVAK supports (legs) for the given type of bathtub in accordance with the assembly manual.  
 For technical drawings of the bathtub, see p. 223.

We recommend supplementing the Chrome bathtub by a bathtub waste set with overflow filler see p. 227.

Design Achim Storz

# Rosa II

A clever bathtub in modern design

We gave asymmetric bathtubs their name.  
If you want quality, ask for RAVAK.





### A spacious shower enclosure together with a comfortable bathtub

The showering part of the bathtub has a flat bottom and integrated seat, and in combination with a bath screen it provides an ideal showering space. The bathing part has a nicely gradual slope of the back portion inviting for comfortable bathing.

### Refreshed design

Builds on the successful bathtub Rosa I which has been refreshed with modern lines by the internationally acclaimed designer Achim Storz.

2101 2351 2601	26 kg 29 kg 32 kg		L/R	10
VOLUME	WEIGHT	CONCEPTS	L/R OPTION	10 YEAR WARRANTY FOR BATHS

Order No.	BATHTUB
CK21000000	ROSA II L 150x105 snowwhite
CJ21000000	ROSA II R 150x105 snowwhite
CM21000000	ROSA II L 160x105 snowwhite
CL21000000	ROSA II R 160x105 snowwhite
C221000000	ROSA II L 170x105 snowwhite
C421000000	ROSA II P 170x105 snowwhite
Order No.	SUPPORTS + PANELS + PANELKITS + HANDLES
CY55000000	Support for ROSA Universal
CZK1200AN0	Frontal panel A ROSA II L 150 cm N snowwhite
CZJ1200AN0	Frontal panel A ROSA II R 150 cm N snowwhite
CZM1200AN0	Frontal panel A ROSA II L 160 cm N snowwhite
CZL1200AN0	Frontal panel A ROSA II R 160 cm N snowwhite
CZ21200AN0	Frontal panel A ROSA II L 170 cm N snowwhite
CZ41200AN0	Frontal panel A ROSA II R 170 cm N snowwhite
B23000100N	Panelkit ROSA Universal
B5320000L0	RAVAK Handle Rosa II L stainless
B5320000P0	RAVAK Handle Rosa II P stainless



Rosa II bathtub can be equipped with the CVSK1 or VSK2 bath screen (see p. 239-240).

**L (left)** - Left-hand product option, **R (right)** - right-hand product option.

Products are as standard delivered within 14 days.

The warranty is contingent on the buyer using original RAVAK supports (legs) for the given type of bathtub in accordance with the assembly manual.

For technical drawings of the bathtub, see p. 223.

Innovated front panel underlines the design of the Rosa II bathtub, speeds up its installation and facilitates access to the plumbing underneath.



# Rosa 95

Small in size, but huge in possibilities

We gave asymmetric bathtubs their name.  
If you want quality, ask for RAVAK.



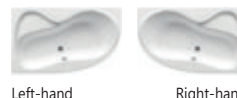

Left-hand

Right-hand

### A spacious shower enclosure together with a comfortable bathtub

The showering part of the bathtub has a flat bottom and integrated seat, and in combination with a bath screen it provides an ideal showering space. The bathing part has a nicely gradual slope of the back portion inviting for comfortable bathing.

### Maximum comfort, space-saving outer dimensions

Keeps the exceptional features of the Rosa bathtubs and yet fits into smaller bathrooms thanks to its width of 95 cm.

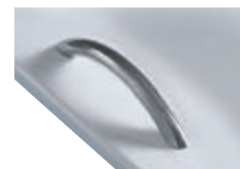

Universal stainless steel handle

1751 2001	24 kg 26 kg		L/R	10
VOLUME	WEIGHT	CONCEPTS	L/R OPTION	10 YEAR WARRANTY FOR BATHS

Order No.	BATHTUB
C551000000	ROSA 95 150x95 L snowwhite
C561000000	ROSA 95 150x95 R snowwhite
C571000000	ROSA 95 160x95 L snowwhite
C581000000	ROSA 95 160x95 R snowwhite
Order No.	SUPPORTS + PANELS + PANELKITS + HANDLES
CY55000000	Support for ROSA Universal
CZ55100A00	Frontal panel A for ROSA 95 L 150 cm snowwhite
CZ56100A00	Frontal panel A for ROSA 95 R 150 cm snowwhite
CZ57100A00	Frontal panel A for ROSA 95 L 160 cm snowwhite
CZ58100A00	Frontal panel A for ROSA 95 R 160 cm snowwhite
B23000100N	Panelkit ROSA Universal
B5C0000000	RAVAK Handle universal stainless



Rosa 95 bathtub can be equipped with the CVSK1 or VSK2 bath screen see p. 239.

**L (left)** - Left-hand product option, **R (right)** - right-hand product option.

Products are as standard delivered within 14 days.

The warranty is contingent on the buyer using original RAVAK supports (legs) for the given type of bathtub in accordance with the assembly manual.

For technical drawings of the bathtub, see p. 223.



# Rosa I

A reliable bathtub for everybody

We gave asymmetric bathtubs their name.  
If you want quality, ask for RAVAK.







### A spacious shower enclosure together with a comfortable bathtub

The showering part of the bathtub has a flat bottom and integrated seat, and in combination with a bath screen it provides an ideal showering space. The bathing part has a nicely gradual slope of the back portion inviting for comfortable bathing.

### Historically, the most popular bathtub on the market

An affordable price, quality, and utility features, smartly combined.

210l 235l 260l	23 kg 27 kg 29 kg		L/R	10
VOLUME	WEIGHT	CONCEPTS	L/R OPTION	10 YEAR WARRANTY FOR BATHS

For the Rosa bathtub, we recommend the Rosa bathtub faucets see p. 394.

Order No.	BATHTUB
CI01000000	ROSA L 140x105 snowwhite
CV01000000	ROSA 140x105 R snowwhite
CK01000000	ROSA L 150x105 snowwhite
CJ01000000	ROSA R 150x105 snowwhite
CM01000000	ROSA L 160x105 snowwhite
CL01000000	ROSA R 160x105 snowwhite
Order No.	SUPPORTS + PANELS + PANELKITS + HANDLES
CY55000000	Support for ROSA Universal
CZH1000A00	Frontal panel A for ROSA 140 cm snowwhite
CZJ1000A00	Frontal panel A for ROSA 150 cm snowwhite
CZL1000A00	Frontal panel A for ROSA 160 cm snowwhite
B23000100N	Panelkit ROSA Universal
B5300000L0	RAVAK Handle Rosa L stainless
B5300000P0	RAVAK Handle Rosa R stainless



Rosa I bathtub can be equipped with the CVSK1 or VSK2 bath screen see p. 240.  
**L (left)** - Left-hand product option, **R (right)** - right-hand product option.  
 Products are as standard delivered within 14 days.  
 The warranty is contingent on the buyer using original RAVAK supports (legs) for the given type of bathtub in accordance with the assembly manual.  
 For technical drawings of the bathtub, see p. 224.

Design Achim Storz



# Avocado

Maximum out of minimum



### Maximum comfort, even with its small dimensions

Comfortable and economical, exactly where you will really appreciate it.

### Uniquely matched

With the basin, it creates an ingenious combination providing you with comfortable use.

158 l 175 l	20 kg 22 kg		L/R	10
VOLUME	WEIGHT	CONCEPTS	L/R OPTION	10 YEAR WARRANTY FOR BATHS

Order No.	BATHTUB
CT01000000	AVOCADO 150 L snowwhite
CS01000000	AVOCADO 150 P snowwhite
CQ01000000	AVOCADO 160 L snowwhite
CH01000000	AVOCADO 160 P snowwhite
Order No.	SUPPORTS + PANELS + PANELKITS
CYS0000000	Support for AVOCADO
CZT1000A00	Frontal panel A for AVOCADO 150 L snowwhite
CZS1000A00	Frontal panel A for AVOCADO 150 R snowwhite
CZQ1000A00	Frontal panel A for AVOCADO 160 L snowwhite
CZI1000A00	Frontal panel A for AVOCADO 160 R snowwhite
B28000000N	Panelkit AVOCADO



Concept Avocado see p. 24.

Avocado bathtub cannot be equipped with a bath screen.

**L (left)** - Left-hand product option, **R (right)** - right-hand product option.

Products are as standard delivered within 14 days.

The warranty is contingent on the buyer using original RAVAK supports (legs) for the given type of bathtub in accordance with the assembly manual.

For technical drawings of the bathtub, see p. 224.



Design Kryštof Nosál



# BeHappy II

The best space-saving solution for comfortable bathing and showering

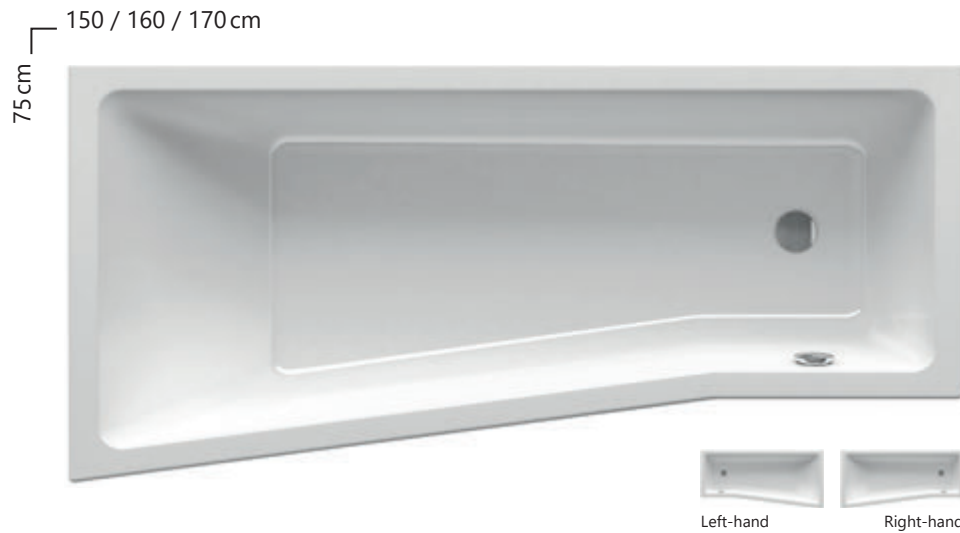

### A unique shape of the bathtub

Innovation of the popular concept for the smallest of bathrooms to further develop and improve the original idea. Bathtub BeHappy II with new, simpler outlines will fit naturally into the bathroom, make use of every centimetre of space and provide an unexpected amount of comfort.

### Bath screen

The bathtub combined with fitted, three-part bath screen VS3 allows comfortable showering.

185l 200l 215l	22 kg 24 kg 25 kg		L/R	10
VOLUME	WEIGHT	CONCEPTS	L/R OPTION	10 YEAR WARRANTY FOR BATHS

Order No.	BATHTUB
C981000000	BE HAPPY II 150x75 L snowwhite
C991000000	BE HAPPY II 150x75 R snowwhite
C961000000	BE HAPPY II 160x75 L snowwhite
C971000000	BE HAPPY II 160x75 R snowwhite
C941000000	BE HAPPY II 170x75 L snowwhite
C951000000	BE HAPPY II 170x75 R snowwhite
Order No.	SUPPORTS + PANELS + PANELKITS
CY94000000	Support for BE HAPPY II
CZ98100A00	Frontal panel for BE HAPPY II 150 L snowwhite
CZ99100A00	Frontal panel for BE HAPPY II 150 R snowwhite
CZ96100A00	Frontal panel for BE HAPPY II 160 L snowwhite
CZ97100A00	Frontal panel for BE HAPPY II 160 R snowwhite
CZ94100A00	Frontal panel for BE HAPPY II 170 L snowwhite
CZ95100A00	Frontal panel for BE HAPPY II 170 R snowwhite
B28100000N	Panelkit 10°, BeHappy II, Chrome 160, 170 x 105



Children's showering and bathing does not necessarily have to end with a flooded bathroom. A precisely fitted bath screen provides pleasant use for everybody. Concept BeHappy II see p. 25.

BeHappy II bathtub can be complemented by a bath screen VS3 (see p. 238).  
**L (left)** - Left-hand product option, **R (right)** - right-hand product option.  
 Products are as standard delivered within 14 days.  
 The warranty is contingent on the buyer using original RAVAK supports (legs) for the given type of bathtub in accordance with the assembly manual.  
 For technical drawings of the bathtub, see p. 224.



# Asymmetric

Universal and keenly priced







### Provides you with a view

The location of the wider part intended for the shoulders provides you with a view of the central part of the bathroom.

### Advantageous asymmetry

Compared to the other bathtubs, its smaller dimensions still provide relatively large bathing space.

190l 215l 240l	25 kg 28 kg 31 kg	L/R	10
VOLUME	WEIGHT	L/R OPTION	10 YEAR WARRANTY FOR BATHS

Order No.	BATHTUB
C441000000	ASYMMETRIC 150x100 L snowwhite
C451000000	ASYMMETRIC 150x100 R snowwhite
C461000000	ASYMMETRIC 160x105 L snowwhite
C471000000	ASYMMETRIC 160x105 R snowwhite
C481000000	ASYMMETRIC 170x110 L snowwhite
C491000000	ASYMMETRIC 170x110 R snowwhite
Order No.	SUPPORTS + PANELS
CY44000000	Support ASYMMETRIC
CZ44100000	Frontal panel for ASYMMETRIC 150 L
CZ45100000	Frontal panel for ASYMMETRIC 150 R
CZ46100000	Frontal panel for ASYMMETRIC 160 L
CZ47100000	Frontal panel for ASYMMETRIC 160 R
CZ48100000	Frontal panel for ASYMMETRIC 170 L
CZ49100000	Frontal panel for ASYMMETRIC 170 R

The panel kit is part of the panel.

Asymmetric bathtub cannot be equipped with a bath screen.

**L (left)** - Left-hand product option, **R (right)** - right-hand product option.

Products are as standard delivered within 14 days.

The warranty is contingent on the buyer using original RAVAK supports (legs) for the given type of bathtub in accordance with the assembly manual.

For technical drawings of the bathtub, see p. 224.

# Technical Drawings - Bathtubs

## Ypsilon

180 x 80

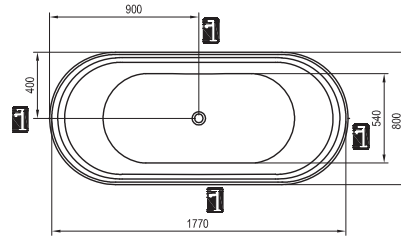
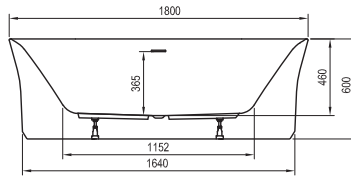

## Solo

178 x 80

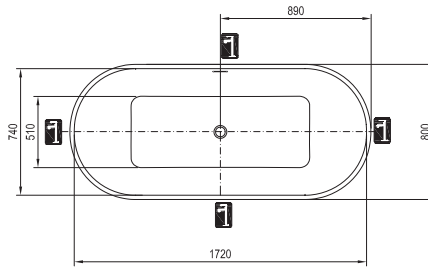
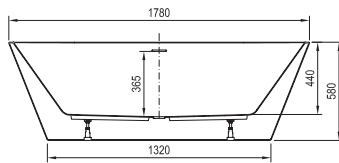

## Freedom O

169 x 80

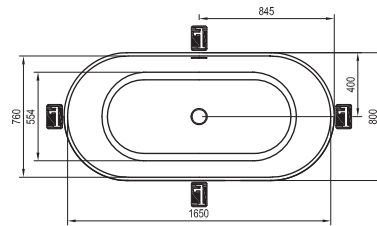
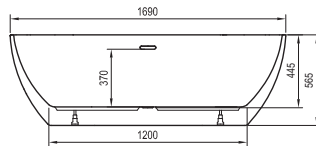

## Freedom W

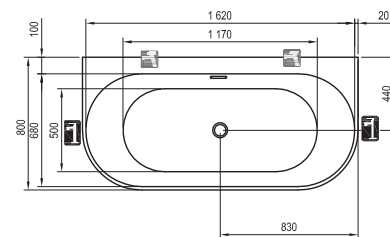
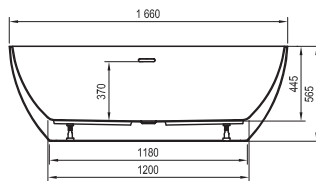

166 x 80

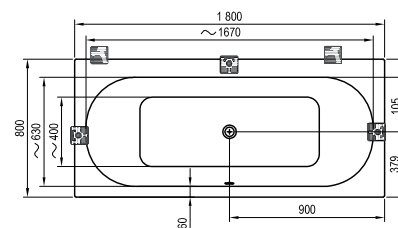
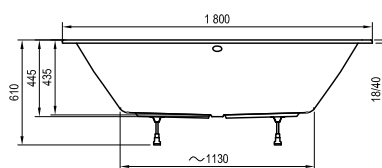

## City / City Slim

180 x 80



-  - Waterfall bathtub filling faucet
-  - Floor-mounted bathtub faucet
-  - Wall-mounted or concealed bathtub faucet

**Formy 01 / Formy 01 Slim**

170 x 75, 180 x 80

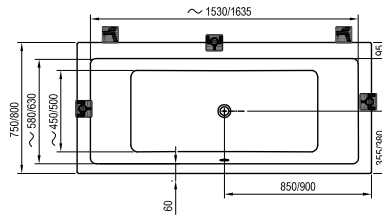
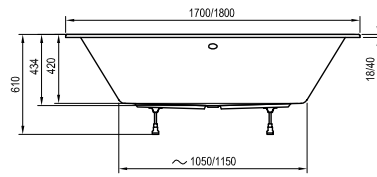

**Formy 02 / Formy 02 Slim**

180 x 80

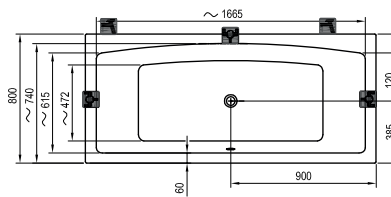
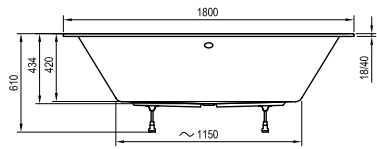

**10°**

170 x 75

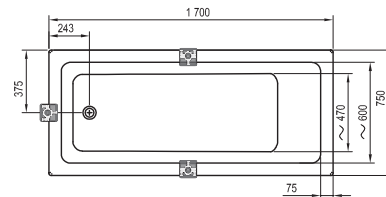
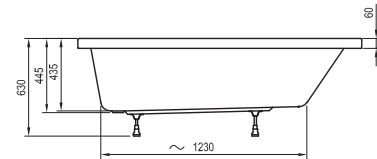

**Campanula II**

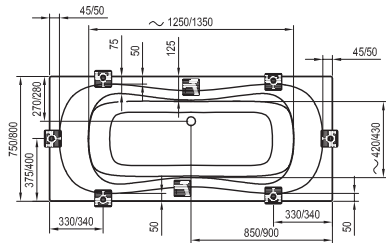
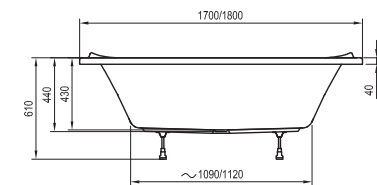

170 x 75, 180 x 80

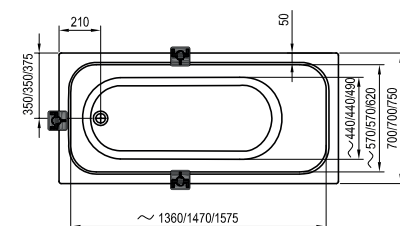
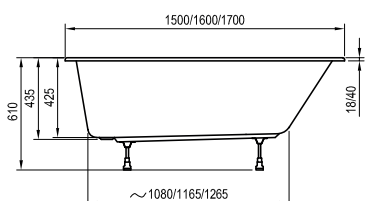

**Chrome / Chrome Slim**

150 x 70, 160 / 170 x 75



-  - Waterfall bathtub filling faucet
-  - Floor-mounted bathtub faucet
-  - Wall-mounted or concealed bathtub faucet



## Classic

120 / 140 / 150 / 160 / 170 x 70

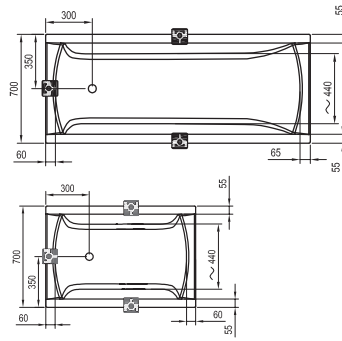
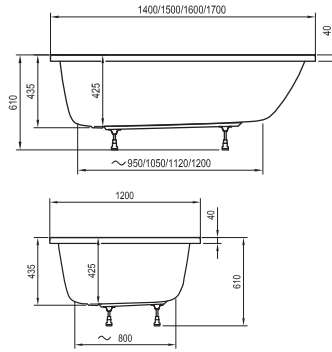

## Vanda II

150 / 160 / 170 x 70

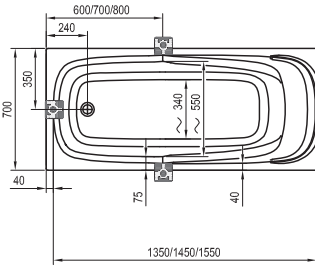
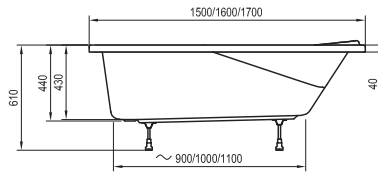

## NewDay

140 x 140, 150 x 150

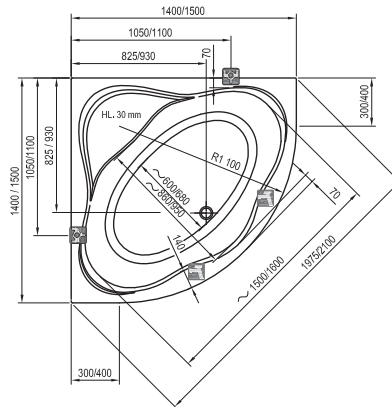
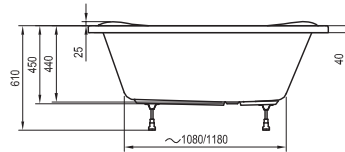

## Gentiana

140 x 140, 150 x 150

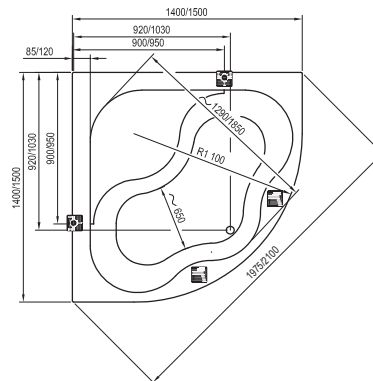
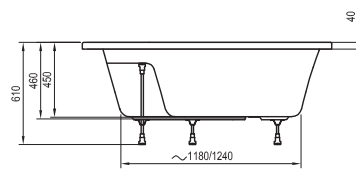

- Waterfall bathtub filling faucet
- Floor-mounted bathtub faucet
- Wall-mounted or concealed bathtub faucet

**LoveStory II**  
196 x 139

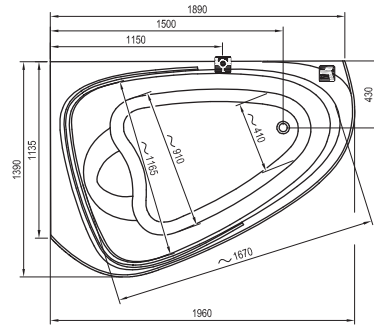
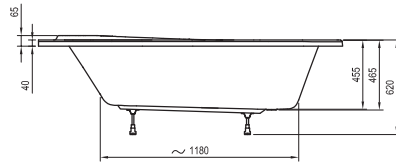

**10°**  
160 x 95, 170 x 100

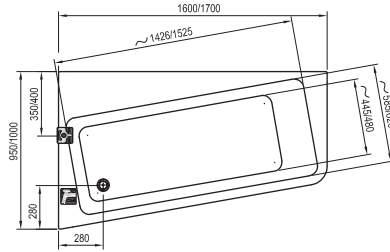
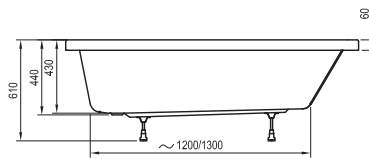

**Chrome**  
160 / 170 x 105

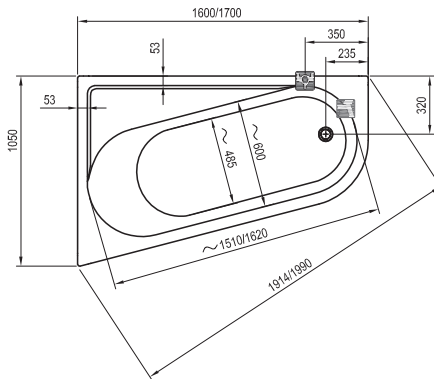
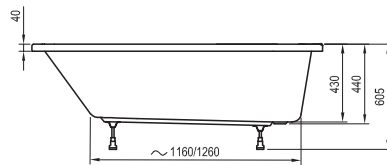

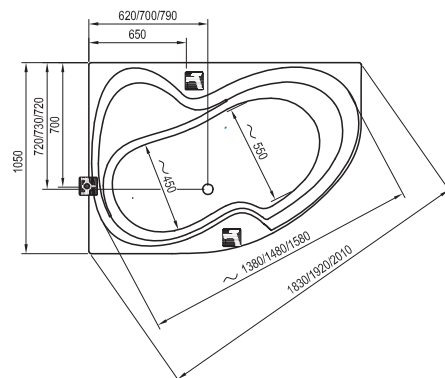
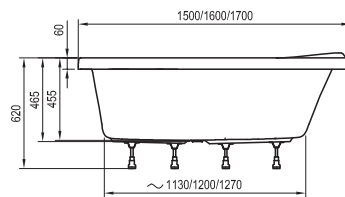

**Rosa II**  
150 / 160 / 170 x 105

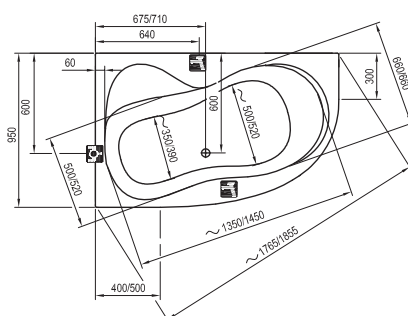
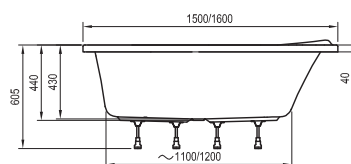

**Rosa 95**  
150 / 160 x 95



-  - Waterfall bathtub filling faucet
-  - Floor-mounted bathtub faucet
-  - Wall-mounted or concealed bathtub faucet

**Rosa I**  
140 / 150 / 160 x 105

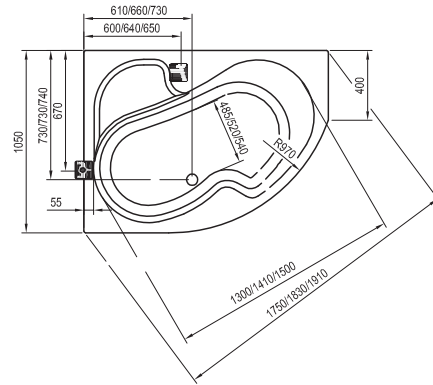
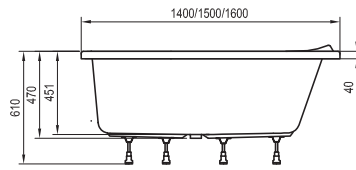

**Avocado**  
150 / 160 x 75

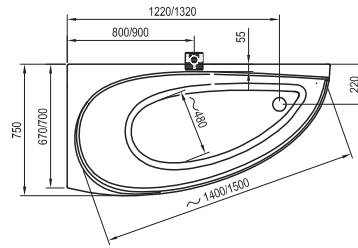
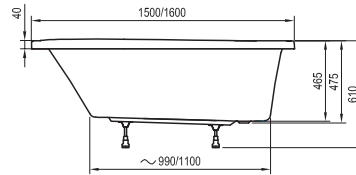

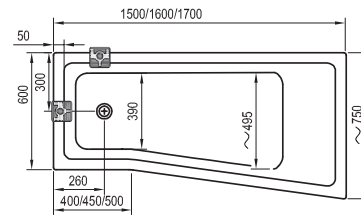
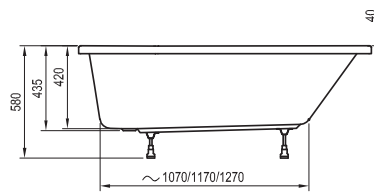

**BeHappy II**  
150 / 160 / 170 x 75

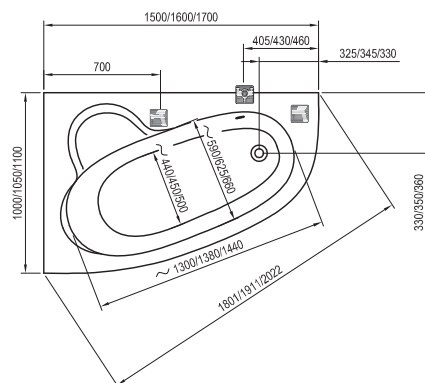
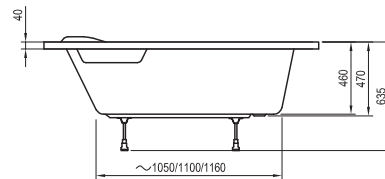

**Asymmetric**  
150 x 100, 160 x 105, 170 x 110



-  - Waterfall bathtub filling faucet
-  - Floor-mounted bathtub faucet
-  - Wall-mounted or concealed bathtub faucet





# Bathtub Accessories



## Bathtub waste sets

Bathtub waste sets are suitable for all types of bathtubs. They are made of top quality materials and differ by their technical and design solutions. We offer two basic types – classic bathtub waste sets with an overflow and bathtub waste sets with an overflow filling.

With regard to draining control, we manufacture the ClickClack mechanism (i.e. the outflow is closed by pressing the waste plug and opens by another pressing), or a system called bowden cable system (i.e. the trap cap is controlled by turning the top control to the open/closed position).



## Bathtub waste sets with an overflow filling system



Waste controlled by the Bowden, length 570, 800 mm.

Waste controlled by the system **ClickClack**, length 570, 800 mm.

Order No. Bathtub waste set with overflow filling II

X01438	Waste controlled by the Bowden – length 570 mm
X01504	Waste controlled by the Bowden – length 800 mm
X01440	Waste controlled by ClickClack – length 570 mm
X01505	Waste controlled by ClickClack – length 800 mm

Overflow filling cannot be used for baths BeHappy II, Avocado, Classic, and size 570 cannot be used for baths Formy 01, Formy 01 Slim, Formy 02, Formy 02 Slim, City and City Slim.

## Classic bathtub waste sets with overflow



Waste controlled by the Bowden, length 570, 800 mm.

Waste controlled by the system **ClickClack**, length 570, 800 mm.

Waste controlled by the Bowden, length 570, 800 mm.

Order No. Bathtub waste set with overflow

X01305	Waste controlled by the Bowden – length 570 mm
X01318	Waste controlled by the Bowden – length 800 mm
X01377	Waste controlled by ClickClack – length 570 mm
X01472	Waste controlled by ClickClack – length 800 mm

Order No. Bathtub waste set with overflow

X01507	Waste controlled by the Bowden – length 570 mm
X01506	Waste controlled by the Bowden – length 800 mm

Size 570 cannot be used for baths Formy 01, Formy 01 Slim, Formy 02, Formy 02 Slim, City and City Slim.



# Cover strips



## Cover strips

Used to seal the gap between the wall and the bathtub. They optimally cover and seal the gap so that cleaning is much easier than in the case of an unevenly applied sealant, which spoils the look of the whole work when dirt settles on it.

Cover strips can be delivered in the lengths of 1100 and 2000 mm and types of 6, 10 or 11 mm. They are suitable for all types of shower trays and bathtubs.

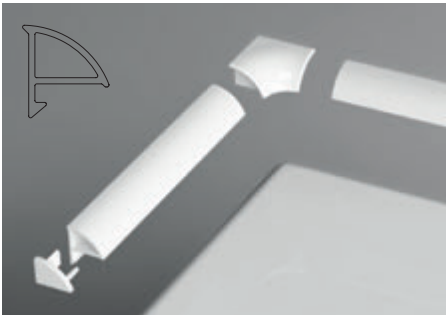

### Cover strip 6

- seals gaps up to 6 mm
- can be supplied with a set containing 2 cover strip end pieces (L,R) and 2 corner connectors

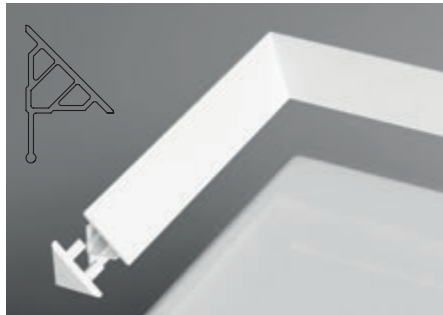

### Cover strip 10

- seals gaps up to 10 mm
- can be supplied with an end piece
- cut at 45 degrees to create a corner

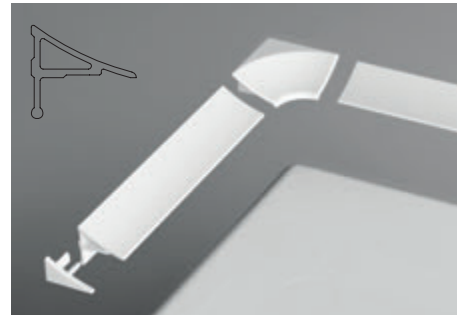

### Cover strip 11

- seals gaps up to 11 mm
- can be supplied with a set containing 2 cover strip end pieces (L,R) and 2 corner connectors

Order No.	Cover strips
XB441100001	Cover strip 6/1100 white
XB442000001	Cover strip 6/2000 white
B440000001	Set for the cover strip 6

Order No.	Cover strips
XB451100001	Cover strip 10/1100 white
XB452000001	Cover strip 10/2000 white
XB430001001	Cover strip end piece 10 white

Order No.	Cover strips
XB461100001	Cover strip 11/1100 white
XB462000001	Cover strip 11/2000 white
B460000001	Set for the cover strip 11



### Sanitary silicone RAVAK Professional - 310 ml

Thanks to its own custom recipe developed over years of testing, RAVAK can offer its customers silicone capable of permanently joining together the diverse materials used in shower enclosure, shower tray and bathtub production. RAVAK silicone is capable of adhering to glass, acrylic, extruded polyester, aluminium, paint and various tiling materials.

RAVAK Professional sanitary silicone comes in two colours – white and clear.  
Order No. X01200 / X01201



# Bath Screens and Doors

They can be mounted into a finished bathroom, both on the common shape and asymmetrically shaped bathtubs.

Designed to keep the bathroom dry, prevent splashing water and allow comfortable showering while standing. We can also customise bath screens, more at [atypical.ravak.com](http://atypical.ravak.com).







## Bath Screens for Rectangular Bathtubs



Bath screens for rectangular bathtubs are universal, always fit perfectly and offer several methods for folding.

### BVS1 Single-part bath screen

It consists of rounded fixtures (B-SET) and a fixed transparent glass panel with a thickness of 8 mm.



Finish



#### BVS1 Bath screen

Order No.	Type + Panel (glass)	Width (mm)
7U840A00Z1	BVS1-80 chrom+glass Transparent	800
D01000A070	B SET BVS1 80 chrom	-

Product height BVS1 - 1500mm.

The bath screen is delivered as:  
 glass part in one package. The second package (B SET)  
 contains the metal parts. Both parts of the product  
 must be ordered separately (glass panels + B SET).

### BVS2 Two-part bath screen

The screen consists of one fixed and one moveable part, which can be swung out of the bathtub. The thickness of the toughened glass is 8mm on the fixed part and 6mm on the moveable part.



Finish



#### BVS2 Bath screen

Order No.	Type + Panel (glass)	Width (mm)
7ULA0A00Z1	BVS2-100 L chrom+glass Transparent	1000
D01000A072	B SET BVS2-L 100 chrom	-
7UPA0A00Z1	BVS2-100 R chrom+glass Transparent	1000
D01000A071	B SET BVS2-P 100 chrom	-

Product height BVS2 - 1500mm.

The bath screen is delivered as:  
 glass part in one package. The second package (B SET)  
 contains the metal parts. Both parts of the product  
 must be ordered separately (glass panels + B SET).

For details about frames and panels, see page 28. Other design options are available in the Custom Solution Configurator at <https://atypical.ravak.com>

**L (left)**-Left-hand product option. **R (right)**-right-hand product option.  
 Products are as standard delivered within 14 days.



# Bath Screens for Rectangular Bathtubs

## CVS2 Two-part bath screen

The screen consists of one fixed and one moveable part which can be swung in and out of the bathtub. The moveable part can thus be opened up at a maximum angle, almost all the way to the washbasin. Thanks to the sophisticated opening method that respects the depth of the washbasin, it is much easier to clean the screen. The bath screen features a holder for better fixation.



Finish



### CVS2 Bath screen

Order No.	Type + Panel (glass/plastic)	Width (mm)
7QLA0100Z1	CVS2-100 L white+Transparent	990
7QLA0U00Z1	CVS2-100 L satin+Transparent	
7QLA0C00Z1	CVS2-100 L bright alu+Transparent	
7QRA0100Z1	CVS2-100 R white+Transparent	
7QRA0U00Z1	CVS2-100 R satin+Transparent	
7QRA0C00Z1	CVS2-100 R bright alu+Transparent	

Product height CVS2 - 1500mm.

## PVS1 Single-part bath screen

PVS1 consists of a vertical profile and one fixed piece. This simple and modern bath screen design is suitable for classic rectangular bathtubs and fits into any bathroom.

With its width of 800mm it provides enough space for comfortable showering.



Finish



### PVS1 Bath screen

Order No.	Type + Panel (glass/plastic)	Width (mm)
79840100Z1	PVS1-80 white+glass Transparent	800
79840C00Z1	PVS1-80 bright alu+glass Transparent	
79840U00Z1	PVS1-80 satin+glass Transparent	
79840300Z1	PVS1-80 black+glass Transparent	

Product height PVS1 - 1400mm.



Play with details and try a bath screen with black vertical profiles.

For details about frames and panels, see page 28. Other design options are available in the Custom Solution Configurator at <https://atypical.ravak.com>

**L (left)**-Left-hand product option. **R (right)**-right-hand product option.

Products are as standard delivered within 14 days.

### VS2 Two-part bath screen

VS2 consists of two parts that can be completely folded to the wall into the inner space above the bathtub. When folded, the screen takes up virtually no space. The width of the VS2 when opened is 1045 mm.

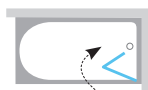

Finish



#### VS2 Bath screen

Order No.	Type + Panel (glass/plastic)	Width (mm)
796M010041	VS2 105 white+polystyrene Rain	1045
796M0100Z1	VS2 105 white+glass Transparent	
796M0100ZG	VS2 105 white+glass Grape	
796M0U0041	VS2 105 satin+polystyrene Rain	
796M0U00Z1	VS2 105 satin+glass Transparent	
796M0U00ZG	VS2 105 satin+glass Grape	

Product height VS2 - 1400mm.

### VS3 Three-part bath screen

VS3 consists of three parts. The widest VS3 model is 25 cm wider than the VS2 bath screen. It can also be folded to the wall to save space. A new feature is the possibility of turning the last screen piece towards the bathtub, which enables its use with the BeHappy II bathtub as well see p. 216.

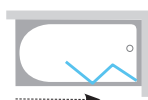

Finish



#### VS3 Bath screen

Order No.	Type + Panel (glass/plastic)	Width (mm)
795P010041	VS3 100 white+polystyrene Rain	996
795P0100Z1	VS3 100 white+glass Transparent	
795P0U0041	VS3 100 satin+polystyrene Rain	
795P0U00Z1	VS3 100 satin +glass Transparent	1 146
795S010041	VS3 115 white+polystyrene Rain	
795S0100Z1	VS3 115 white+glass Transparent	
795S0U0041	VS3 115 satin+polystyrene Rain	
795S0U00Z1	VS3 115 satin+glass Transparen	1 296
795V010041	VS3 130 white+Rain	
795V0100Z1	VS3 130 white+glass Transparent	
795V0100ZG	VS3 130 white+glass Grape	
795V0U0041	VS3 130 satin+polystyrene Rain	
795V0U00Z1	VS3 130 satin+glass Transparent	
795V0U00ZG	VS3 130 satin+glass Grape	

Product height VS3 - 1400mm. The VS3 100 bath screen is suitable for the BeHappy bathtub with sizes 150, 160 cm, the VS3 115 is for the BeHappy of 170 cm.

# Bath Screens for Rectangular Bathtubs

## VS5 Five-part bath screen

VS5, the so-called concertina bath screen, is the most effective space-saving option as the screen can be folded to the wall. The width of the VS5 is 1135 mm.

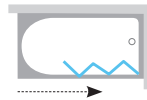

Finish

WHITE



L/R OPTION



## VS5 Bath screen

Order No.	Type + Panel (glass/plastic)	Width (mm)
794E010041	VS5 white+polystyrene Rain	1135

Product height VS5 - 1330mm.

## AVDP3 Bath door

Use the AVDP3 bath door to create a perfectly waterproof shower space above the bathtub. Turn the product 180 degrees to obtain either right hand or left hand entry option.



Finish

SATIN WHITE



GLASS PROTECTION



SILENT OPERATION



10

10 YEAR WARRANTY FOR ANTIBLOCK



L/R OPTION



The AVDP3 bath door can be widened by up to 2 cm using the ANPV extension profile.  
▶ see p. 30, 126

## AVDP3 Bath door

Order No.	Type + Panel (glass/plastic)	Entrance (mm)	Width (mm)
40VG010241	■ AVDP3-120 white+polystyrene Rain	661	1170 - 1210
40VG0102Z1	■ AVDP3-120 white+glass Transparent		
40VG0102ZG	■ AVDP3-120 white+glass Grape		
40VG0U0241	■ AVDP3-120 satin+polystyrene Rain		
40VG0U02Z1	■ AVDP3-120 satin+glass Transparent		
40VG0U02ZG	■ AVDP3-120 satin+glass Grape		
40VP010241	AVDP3-150 white+polystyrene Rain	861	1470 - 1510
40VP0102Z1	■ AVDP3-150 white+glass Transparent		
40VP0102ZG	■ AVDP3-150 white+glass Grape		
40VPU0241	AVDP3-150 satin+polystyrene rain		
40VPU02Z1	■ AVDP3-150 satin+glass Transparent		
40VPU02ZG	■ AVDP3-150 satin+ glass Grape		
40VS010241	AVDP3-160 white+polystyrene Rain	928	1570 - 1610
40VS0102Z1	■ AVDP3-160 white+glass Transparent		
40VS0102ZG	■ AVDP3-160 white+glass Grape		
40VS0U0241	AVDP3-160 satin+ polystyrene Rain		
40VS0U02Z1	■ AVDP3-160 satin+glass Transparent		
40VS0U02ZG	■ AVDP3-160 satin+glass Grape		
40VV010241	AVDP3-170 white+polystyrene Rain	995	1670 - 1710
40VV0102Z1	■ AVDP3-170 white+glass Transparent		
40VV0102ZG	AVDP3-170 white+glass Grape		
40VV0U0241	AVDP3-170 satin+polysytrene Rain		
40VV0U02Z1	■ AVDP3-170 satin+glass Transparent		
40VV0U02ZG	AVDP3-170 satin+glass Grape		
40VY010241	AVDP3-180 white+polystyrene Rain	1061	1770 - 1810
40VY0102Z1	■ AVDP3-180 white+glass Transparent		
40VY0102ZG	AVDP3-180 white+glass Grape		
40VY0U0241	AVDP3-180 satin+polystyrene Rain		
40VY0U02Z1	■ AVDP3-180 satin+glass Transparent		
40VY0U02ZG	AVDP3-180 satin+glass Grape		

Product height AVDP3 - 1370mm. ■ 6 week delivery time.



# Bath Doors for Rectangular Bathtubs



## APS fixed screen for combining with AVDP3

Do you need to create a thoroughly watertight shower enclosure above your bathtub? Use the AVDP3 bath door (see p.236) in combination with the APS fixed screen.



Finish

SATIN WHITE



### APS Fixed screen

Order No.	Type + Panel (glass/plastic)	Width (mm)
9501010241	APSV-70 white+polystyrene Rain	670 - 705
95010102Z1	■ APSV-70 white+glass Transparent	
95010102ZG	■ APSV-70 white+glass Grape	
95010U0241	APSV-70 satin+polystyrene Rain	
95010U02Z1	■ APSV-70 satin+glass Transparent	
95010U02ZG	■ APSV-70 satin+ glass Grape	
9503010241	APSV-75 white+polystyrene Rain	720 - 755
95030102Z1	■ APSV-75 white+glass Transparent	
95030102ZG	■ APSV-75 white+glass Grape	
95030U0241	APSV-75 satin+polystyrene Rain	
95030U02Z1	■ APSV-75 satin+glass Transparent	
95030U02ZG	■ APSV-75 satin+ glass Grape	
9504010241	APSV-80 white+polystyrene Rain	770 - 805
95040102Z1	■ APSV-80 white+glass Transparent	
95040102ZG	■ APSV-80 white+glass Grape	
95040U0241	APSV-80 satin+polystyrene Rain	
95040U02Z1	■ APSV-80 satin+glass transparent	
95040U02ZG	■ APSV-80 satin+glass Grape	

Product height APSV - 1370 mm. ■ 6 week delivery time.

### ANPV Extension profile

Order No.	Type	Height (mm)
E778803113702	ANPV white	1370
E778803U13702	Extension profile ANPV satin	

For details about frames and panels, see page 28. Other design options are available in the Custom Solution Configurator at <https://atypical.ravak.com>  
 Products are as standard delivered within 14 days.

## Bath Screens for Asymmetric Bathtubs



Screens for asymmetrical bathtubs are made to measure so that they perfectly fit the shape of the bathtub and allow comfortable showering when standing. Your asymmetrical bathtub can thus also serve as a comfortable shower enclosure.

### 10CVS2 Two-part bath screen

Designed for 10° bathtubs.  
The screen can be moved into the inner space above the bathtub or out towards the wall.



Finish



### 10CVS2 Bath screen

Order No.	Type + Panel (glass/plastic)	Width (mm)
7QLA0103Z1	10CVS2-100 L white+ Transparent	990
7QLA0C03Z1	10CVS2-100 L bright alu+ Transparent	
7QLA0U03Z1	10CVS2-100 L satin+ Transparent	
7QRA0103Z1	10CVS2-100 R white+ Transparent	
7QRA0C03Z1	10CVS2-100 R bright alu+ Transparent	
7QRA0U03Z1	10CVS2-100 R satin+ Transparent	

Product height 10CVS2 - 1500mm.

### CVSK1 Single-part bath screen

Designed for the Rosa I, Rosa II, and Rosa 95 bathtubs.  
The screen can be moved into the inner space above the bathtub or out towards the wall.

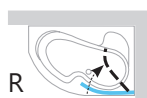

Finish



### CVSK1 Bath screen

Order No.	Type + Panel (glass/plastic)	Width (mm)
7QLM0100Y1	CVSK1 ROSA 140/150 L white+ Transparent	850
7QLM0C00Y1	CVSK1 ROSA 140/150 L bright alu+ Transparent	
7QLM0U00Y1	CVSK1 ROSA 140/150 L satin+ Transparent	
7QRM0100Y1	CVSK1 ROSA 140/150 R white+ Transparent	
7QRM0C00Y1	CVSK1 ROSA 140/150 R bright alu+ Transparent	
7QRM0U00Y1	CVSK1 ROSA 140/150 R satin+ Transparent	
7QLS0100Y1	CVSK1 ROSA 160/170 L white+ Transparent	1000
7QLS0C00Y1	CVSK1 ROSA 160/170 L bright alu+ Transparent	
7QLS0U00Y1	CVSK1 ROSA 160/170 L satin+ Transparent	
7QRS0100Y1	CVSK1 ROSA 160/170 R white+ Transparent	
7QRS0C00Y1	CVSK1 ROSA 160/170 R bright alu+ Transparent	
7QRS0U00Y1	CVSK1 ROSA 160/170 R satin+ Transparent	

Product height CVSK1 - 1500mm.

For details about frames and panels, see page 28. Other design options are available in the Custom Solution Configurator at <https://atypical.ravak.com>

**L (left)**-Left-hand product option. **R (right)**-right-hand product option.  
Products are as standard delivered within 14 days.



# Bath Screens for Asymmetric Bathtubs

## VSK2 Two-part bath screen

Designed for the Rosa I, Rosa II, and Rosa 95 bathtubs. For better stabilization we recommend fastening with the VSK2 short or long holder.



Finish

WHITE

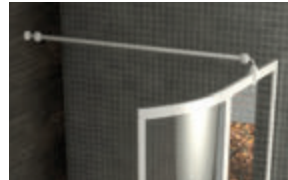

Short holder  
Long holder  
(The long holder can be used for the Rosa 95 bathtub)

## VSK2 Bath screen

Order No.	Type + Panel (glass/plastic)	Width (mm)	Compatible with
76L7010041	VSK2 ROSA 140 L white+polystyrene Rain	450 + 445	Rosa I 140
76L70100Z1	VSK2 ROSA 140 L white+glass Transparent		
76P7010041	VSK2 ROSA 140 R white+polystyrene Rain	450 + 445	Rosa I 140
76P70100Z1	VSK2 ROSA 140 R white+glass Transparent		
76L8010041	VSK2 ROSA 150 L white+polystyrene Rain	480 + 445	Rosa II 150, Rosa I 150, Rosa 95
76L80100Z1	VSK2 ROSA 150 L white+glass Transparent		
76P8010041	VSK2 ROSA 150 P white+polystyrene Rain		
76P80100Z1	VSK2 ROSA 150 R white+glass Transparent		
76L9010041	VSK2 ROSA 160 L white+polystyrene Rain	535 + 445	Rosa II 160, Rosa I 160, Rosa 95
76L90100Z1	VSK2 ROSA 160 L white+glass Transparent		
76P9010041	VSK2 ROSA 160 P white+polystyrene Rain		
76P90100Z1	VSK2 ROSA 160 R white+glass Transparent		
76LB010041	VSK2 ROSA II 170 L polystyrene Rain	635 + 445	Rosa II 170
76LB0100Z1	VSK2 ROSA II 170 L glass Transparent		
76PB010041	VSK2 ROSA II 170 R polystyrene Rain		
76PB0100Z1	VSK2 ROSA II 170 R glass Transparent		
B110000001	Holder VSK2 short		
B120000001	Holder VSK2 long		(The long holder can be used for the Rosa 95 bathtub)

Product height VSK2 Rosa - 1500mm.

For details about frames and panels, see page 28. Other design options are available in the Custom Solution Configurator at <https://atypical.ravak.com>

**L (left)**-Left-hand product option. **R (right)**-right-hand product option.

Products are as standard delivered within 14 days.



# Washbasins and Bathroom Furniture

You can choose simple modern lines of ceramic washbasins or a wide variety of cast marble washbasins.





5-year warranty on washbasins  
and bathroom furniture



# Washbasins and Furniture

The ideal combination of top-quality materials and outstanding manufacturing quality. Choose a washbasin made of ceramic or cast marble and complement it with a countertop or a cabinet with storage space.

---

## **Moon** p. 246

**Moon 1, Moon 1C, Moon 2, Moon 2S, Moon 3**  
cast marble

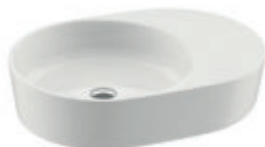

## **Formy** p. 250

**Formy 01, Formy 02**  
cast marble



## **Solo** p. 252

**Solo**  
cast marble



## **Ceramic** p. 254

**Ceramic Slim , Ceramic**  
ceramic



## **Uni Slim and Uni** p. 258

**Uni Slim, Uni**  
ceramic



## **Uni Slim B, S, R** p. 260

**Uni Slim B, Uni Slim S, Uni Slim R**  
ceramic



## **Countertop in the shape of L** p. 262

Washbasin countertop



## **Countertop in the shape of I** p. 262

Washbasin countertop



## **SUD** p. 264

Vanity unit for countertop washbasin



**new**

## **Step** p. 282

Vanity unit for countertop washbasin



## **Formy** p. 286

Vanity unit for countertop washbasin



Our bathroom furniture comes in a wide variety of surface finishes (varnish, veneer, foil). Find more details by each product.

---





## Washbasins Moon



Design Kryštof Nosál

Countertop washbasins in the spirit of modern trends. Their subtle look and choice from many uncomplicated shapes benefit every bathroom.



reddot award 2018  
winner



A set of five countertop washbasins which are based on the geometrical shape of a circle and its modifications. The most natural solution for every modern bathroom.



Veneered surface panels bring cosiness and comfort to the bathroom. Special deep impregnation of the board using AMT (Anti Moisture Treatment) technology will perfectly protect the furniture against the effects of moisture.

## Washbasin Moon 1 - cast marble

400 x 400 x 120 mm  
Circle

The washbasin needs to be equipped with the fixed washbasin waste plug.

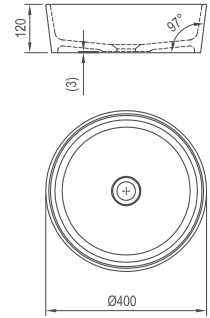

Order No.	WASHBASINS	Weight (kg)	Dimensions (mm)
XJN01300000	MOON 1 white without overflow	7,0	400x400x120

## Washbasin Moon 1C - cast marble

400 x 355 x 120 mm  
Cut model, C shaped

The washbasin needs to be equipped with the fixed washbasin waste plug.

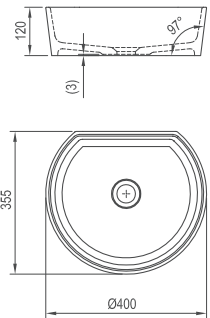

Order No.	WASHBASINS	Weight (kg)	Dimensions (mm)
XJN01300001	MOON 1C white without overflow	7,3	400x355x120

## Washbasin Moon 2 - cast marble

560 x 400 x 120 mm  
Oval

The washbasin needs to be equipped with the fixed washbasin waste plug.

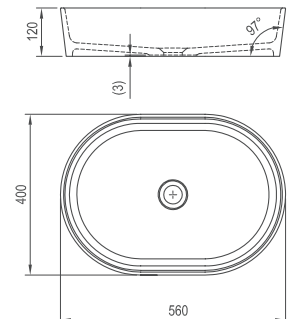

Order No.	WASHBASINS	Weight (kg)	Dimensions (mm)
XJN01300002	MOON 2 white without overflow	9,8	560x400x120



## Washbasin Moon 2S - cast marble

560 x 400 x 120 mm  
Oval with shelf space.

The washbasin needs to be equipped with the fixed washbasin waste plug.

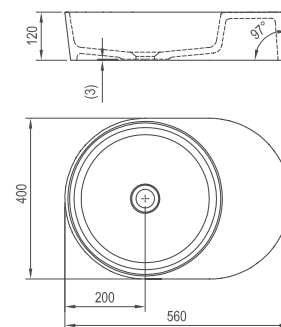
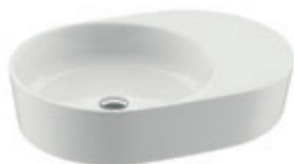

Order No.	WASHBASINS	Weight (kg)	Dimensions (mm)
XJN01300003	MOON 2S white without overflow	13,2	560x400x120

## Washbasin Moon 3 - cast marble

463 x 389 x 120 mm  
Irregular shape

The washbasin needs to be equipped with the fixed washbasin waste plug.

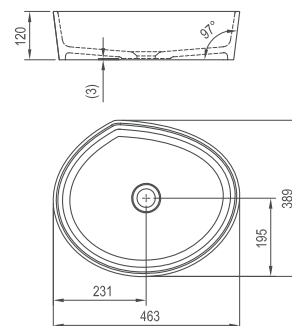

Order No.	WASHBASINS	Weight (kg)	Dimensions (mm)
XJN01300004	MOON 3 white without overflow	8,0	463x389x120

Order No.	ACCESSORIES
X01439	plug fixed chrome
X01695	plug fixed ceramic
X01371	siphon chrome
X01612	Furniture siphon
See p. 341.	

# Washbasins Formy



Design Kryštof Nosál



Real wood veneer

Two different shapes, either for a minimalist bathroom or a more dynamic atmosphere. The design of washbasins Formy 01 and Formy 02 matches the bathtubs from the concept of the same name.



CONCEPTS  
Concept Formy



5-YEAR WARRANTY



ANTI-MOISTURE FINISH

## Washbasin Formy 01 - cast marble

500 / 600 x 390 x 140 mm

Pleasantly large space for washing and universally modern shapes. Designed for combination with a countertop.

The washbasins must be combined with the fixed washbasin waste plug.

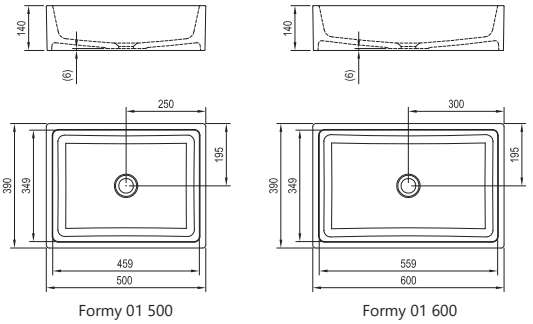

Order No.	WASHBASINS	Weight (kg)	Dimensions (mm)
XJL01250000	FORMY 01 500 D white without overflow	18,6	500x390x140
XJL01260000	FORMY 01 600 D white without overflow	20,6	600x390x140

## Washbasin Formy 02 - cast marble

500 / 600 x 410 x 140 mm

Apart from practical advantages, it provides an aesthetic experience thanks to the slightly arched shapes. The washbasin is designed to be combined with a washbasin countertop.

The washbasins must be combined with the fixed washbasin waste plug.

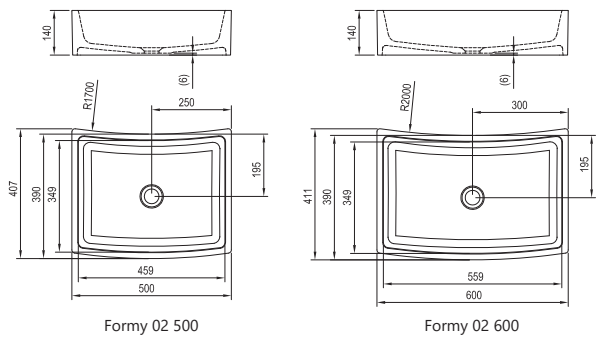

Order No.	WASHBASINS	Weight (kg)	Dimensions (mm)
XJM01250000	FORMY 02 500 D white without overflow	18,7	500x410x140
XJM01260000	FORMY 02 600 D white without overflow	21,2	600x410x140

Order No.	ACCESSORIES
X01439	plug fixed chrome
X01695	plug fixed ceramic
X01371	siphon chrome
X01612	Furniture siphon
See p. 341.	

Washbasin dimensions specified as: width x depth x height. Product weight is listed as gross, i.e. including packaging. Products are as standard delivered within 14 days.



# Washbasin Solo



A washbasin that combines proven rectangular and oval shapes for new bathroom aesthetics. Possible to combine with a freestanding bathtub.

5

5-YEAR WARRANTY

## Washbasin Solo - cast marble

580 x 400 x 140 mm

Subtle lines and generous space, an innovative combination of classic shapes.

The washbasin needs to be equipped with the fixed washbasin waste plug.

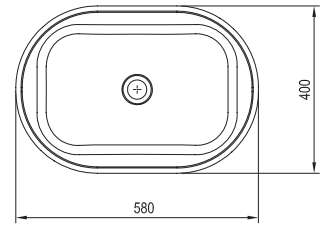
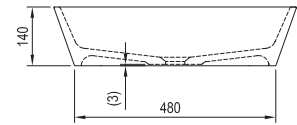

Order No.	WASHBASINS	Weight (kg)	Dimensions (mm)
XJX01358000	SOLO 580 white without overflow	13,8	580x400x140

Order No.	ACCESSORIES
X01439	plug fixed chrome
X01695	plug fixed ceramic
X01371	siphon chrome
X01612	Furniture siphon

See p. 341.



Faucets Chrome see p. 372

# Washbasins Ceramic Slim and Ceramic



Design Kryštof Nosál



An attractive combination of tenderness and durability. The thin-walled ceramic design makes it possible to create precisely defined thin edges and delivers visual lightness to the Ceramic Slim washbasins.





Countertop washbasins made of high quality ceramics in modern yet timeless design will never cease to be an adornment for your bathroom even after years of use.

### Washbasin Ceramic Slim O - ceramic

550 x 370 x 120 mm

The thin-walled Ceramic washbasin has precisely defined subtle edges.

The washbasin needs to be equipped with the fixed washbasin waste plug.

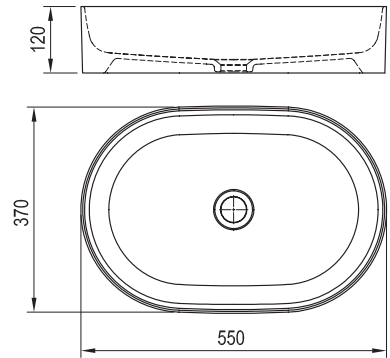

Order No.	WASHBASINS	Weight (kg)	Dimensions (mm)
XJX01155001	Ceramic 550 O Slim ceramic white	9,0	550x370x120

### Washbasin Ceramic Slim R - ceramic

550 x 370 x 120 mm

The thin-walled Ceramic washbasin has precisely defined subtle edges.

The washbasin needs to be equipped with the fixed washbasin waste plug.

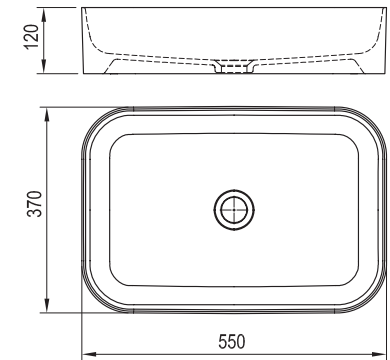

Order No.	WASHBASINS	Weight (kg)	Dimensions (mm)
XJX01155002	Ceramic 550 R Slim ceramic white	10,4	550x370x120

Order No.	ACCESSORIES
X01439	plug fixed chrome
X01695	plug fixed ceramic
X01371	siphon chrome
X01436	siphon chrome U tubular
X01612	Furniture siphon
See p. 341.	

5

5-YEAR WARRANTY

## Washbasin Ceramic O - ceramic

600 x 400 x 120mm

The Ceramic O washbasin will pleasantly balance out the austerity of right angles in the bathroom.

The washbasins must be combined with the fixed washbasin waste plug.

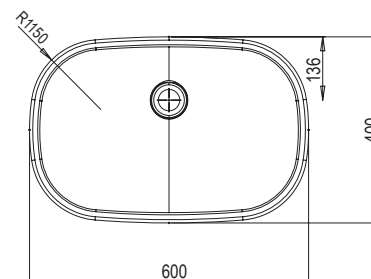
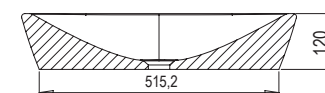

Order No.	WASHBASINS	Weight (kg)	Dimensions (mm)
XJX01160001	Ceramic 600 O ceramic white	12,5	600x400x120

## Washbasin Ceramic R - ceramic

600 x 400 x 120mm

The Ceramic R washbasin follows the trend of modern straight lines, yet moderates, soothes and rounds their sharpness.

The washbasins must be combined with the fixed washbasin waste plug.

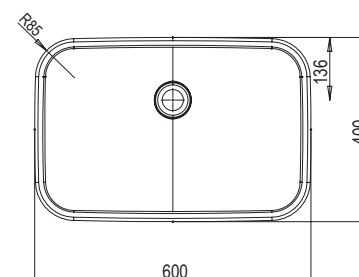
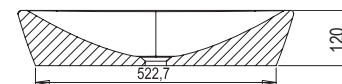

Order No.	WASHBASINS	Weight (kg)	Dimensions (mm)
XJX01160002	Ceramic 600 R ceramic white	13,0	600x400x120

Order No.	ACCESSORIES
X01439	plug fixed chrome
X01695	plug fixed ceramic
X01371	siphon chrome
X01436	siphon chrome U tubular
X01612	Furniture siphon

See p. 341.



## Washbasins Uni Slim and Uni



Circular ceramic washbasins are an unforgettable classic for refreshing the modern bathroom.

5

5-YEAR WARRANTY

## Washbasin Uni Slim - ceramic

400 x 400 x 120 mm

The shape of a circle combines with the delicate beauty of thin-walled ceramic.

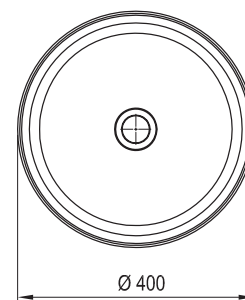

Order No.	WASHBASINS	Weight (kg)	Dimensions (mm)
XJX01140002	Uni 400 Slim ceramic white	6,3	400x400x120

## Washbasin Uni - ceramic

400 x 400 x 120 mm

Evokes a feeling of calm thanks to a combination of natural shapes and traditional ceramic material.

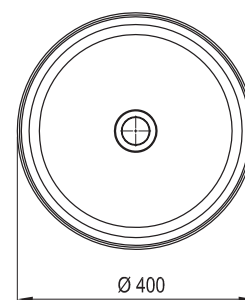

Order No.	WASHBASINS	Weight (kg)	Dimensions (mm)
XJX01140001	Uni 400 ceramic white	7,2	400x400x120

Order No.	ACCESSORIES
X01439	plug fixed chrome
X01695	plug fixed ceramic
X01371	siphon chrome
X01436	siphon chrome U tubular
X01612	Furniture siphon

See p. 341.

## Washbasins Uni Slim



Washbasins from the Uni Slim line bring playfulness, lightness and variability into the bathroom. Their uncomplicated shapes and austere lines combined with modest size will suit a lively bathroom. Ideal for combining with a washbasin countertop.



5

5-YEAR WARRANTY

### Washbasin Uni Slim B - ceramic

400 x 400 x 125 mm

Gracefully arched shape reminiscent of a bowl invites you to play with water. Tried and tested size and depth suit all interiors and entice to double washbasin combinations for larger families.

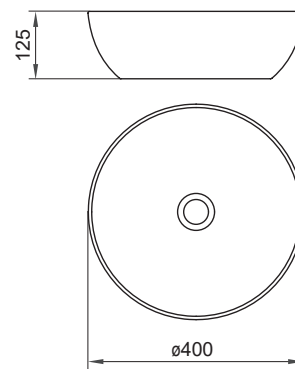

Order No.	WASHBASINS	Weight (kg)	Dimensions (mm)
XJX01140003	Uni 400 B Slim ceramic white	7,2	400x400x125

### Washbasin Uni Slim S - ceramic

380 x 380 x 125 mm

The washbasin was inspired by the shape of a square, though softened by rounded edges. Ideal in a dual washbasin setup for larger families.

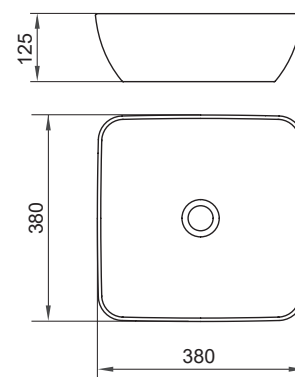

Order No.	WASHBASINS	Weight (kg)	Dimensions (mm)
XJX01138001	Uni 380 S Slim ceramic white	7,0	380x380x125

### Washbasin Uni Slim R - ceramic

500 x 310 x 125 mm

The generous width of the washbasin allows its use without limitations. The arched shape will keep all the water safely inside. Ceramic material thinned into delicate edges lends the washbasin elegance and timelessness.

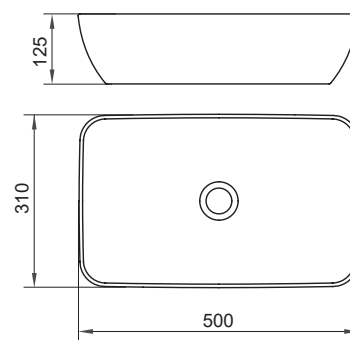

Order No.	WASHBASINS	Weight (kg)	Dimensions (mm)
XJX01150001	Uni 500 R Slim ceramic white	7,9	500x310x125

Order No.	ACCESSORIES
X01439	plug fixed chrome
X01695	plug fixed ceramic
X01371	siphon chrome
X01612	Furniture siphon

See p. 341.

Washbasin dimensions specified as: width x depth x height. Product weight is listed as gross, i.e. including packaging. Products are as standard delivered within 14 days.

## Washbasin Countertops



Pleasantly enlarge the space around the washbasin. Surface finish ensures perfect resistance to humidity.

5

5-YEAR WARRANTY



ANTI-MOISTURE FINISH

Countertop

White gloss

Walnut veneer

Oak veneer

## Countertop in the shape of L

800 / 1000 / 1200 x 550 x 50 mm

A countertop with a unique shape, primarily designed for the Moon, Formy, and Solo countertop washbasins and the Ceramic, Ceramic Slim, Uni, and Uni Slim ceramic washbasins. Mounting onto the wall using special hidden brackets included in the delivery. Pre-drilled hole for central installation of a countertop washbasin, deep impregnation for maximum durability in wet environments. Finish in white colour or two types of veneer (oak, walnut).

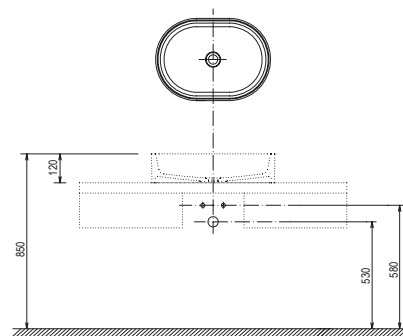
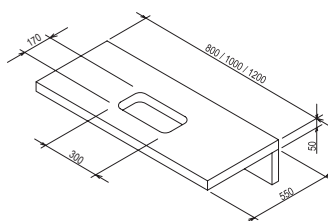

White



Walnut veneer



Oak veneer

Order No.	COUNTERTOPS	Weight (kg)	Dimensions (mm)
X00000833	Countertop L 800 oak	20,0	800x550x50
X00000836	Countertop L 800 dark walnut		
X00000830	Countertop L 800 white		
X00000834	Countertop L 1000 oak	22,5	1000x550x50
X00000837	Countertop L 1000 dark walnut		
X00000831	Countertop L 1000 white		
X00000835	Countertop L 1200 oak	27,0	1200x550x50
X00000838	Countertop L 1200 dark walnut		
X00000832	Countertop L 1200 white		

## Countertop in the shape of I

800 / 1000 / 1200 x 550 x 70 mm

Universal washbasin countertop. Attachment using classic brackets included in the package. Without a pre-drilled hole for any location of the basin, the countertop is suitable for the majority of basins thanks to sufficient depth (distance from the wall). Finish in white colour or two types of veneer (oak, walnut).

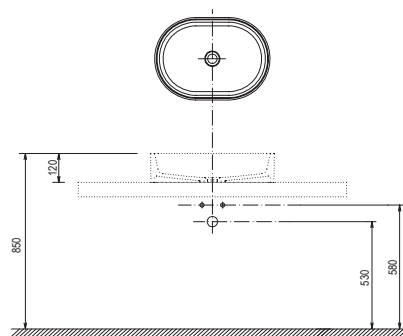
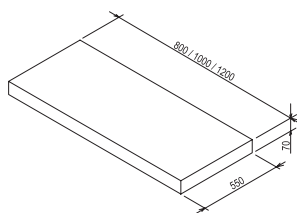

White



Walnut veneer



Oak veneer

Order No.	COUNTERTOPS	Weight (kg)	Dimensions (mm)
X00000842	Countertop I 800 oak	15,0	800x550x70
X00000845	Countertop I 800 dark walnut		
X00000839	Countertop I 800 white		
X00000843	Countertop I 1000 oak	17,5	1000x550x70
X00000846	Countertop I 1000 dark walnut		
X00000840	Countertop I 1000 white		
X00000844	Countertop I 1200 oak	19,0	1200x550x70
X00000847	Countertop I 1200 dark walnut		
X00000841	Countertop I 1200 white		



## Vanity unit SUD for countertop washbasins



Design Kryštof Nosál

Elegant space for storing all the little things you do not want to be seen in the bathroom. Universal vanity unit under countertop washbasins.

5

5-YEAR WARRANTY



ANTI-MOISTURE FINISH

Colour finish:



SUD

1100 x 530 x 260mm

A design solitaire for countertop washbasins with generous storage space and an elegant aluminium handle.

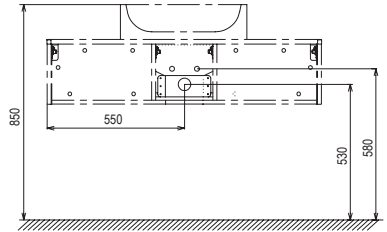
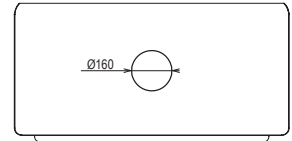
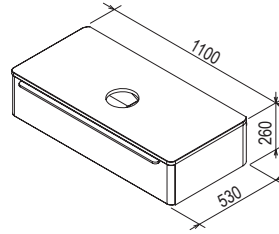

White



Walnut



Oak



Satin wood

Order No.	FURNITURE	Weight (kg)	Dimensions (mm)
X000001082	SUD 260.01 1100 white		
X000001083	SUD 260.01 1100 oak	38,5	1100x530x260
X000001084	SUD 260.01 1100 walnut		
X000001101	SUD 260.01 1100 satin wood		



Furniture dimensions specified as: width x depth x height. Product weight is listed as gross, i.e. including packaging. Products are as standard delivered within 14 days.

# Ceramic washbasins and Furniture Balance



Design by Michał Roszkowski

Vanity units with an inset ceramic washbasin or fitted with a countertop address a wide range of requirements of a modern bathroom.





The Balance line allows you to assemble your own furniture and washbasin set according to your individual needs for storage space.

5

5-YEAR WARRANTY



ANTI-MOISTURE  
FINISH

## Washbasin Balance 500/600/800 - ceramic

500 / 600 / 800 x 465 mm

The washbasin is designed for inseting into the SD Balance vanity unit. It cannot be mounted separately to the wall and must be combined with a washbasin waste trap with a fixed waste plug.

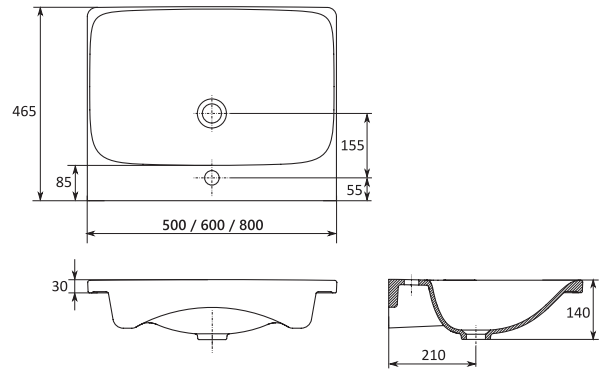

Order No.	WASHBASINS	Weight (kg)	Dimensions (mm)
XJX01250000	Balance 500 ceramic white	9,9	500x465 mm
XJX01260000	Balance 600 ceramic white	10,8	600x465 mm
XJX01280000	Balance 800 ceramic white	14,8	800x465 mm
X01723	siphon with fixed waste plug	0,6	-

## SD Balance 500/600/800

500 / 600 / 800 x 465 x 500 mm

Wall-mounted vanity unit with two drawers.

When combined with the Balance washbasin, it is necessary to use a waste trap with a fixed waste plug for Balance furniture.

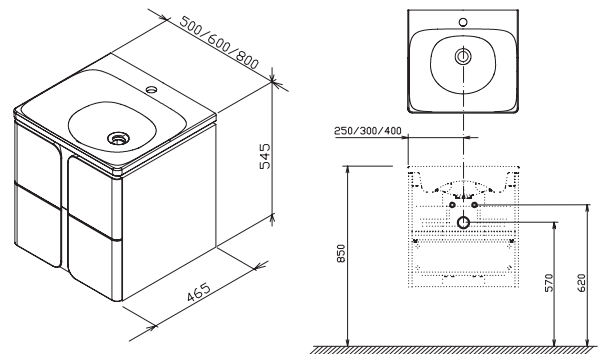

White



White/grafit

Order No.	FURNITURE	Weight (kg)	Dimensions (mm)
X000001364	SD Balance 500 white/white	25,0	500 x 465 x 500
X000001365	SD Balance 500 white/graphite	25,0	500 x 465 x 500
X000001366	SD Balance 600 white/white	29,0	600 x 465 x 500
X000001367	SD Balance 600 white/graphite	29,0	600 x 465 x 500
X000001368	SD Balance 800 white/white	34,0	800 x 465 x 500
X000001369	SD Balance 800 white/graphite	34,0	800 x 465 x 500

Furniture dimensions specified as: width x depth x height. Product weight is listed as gross, i.e. including packaging.

Products are as standard delivered within 14 days.

Washbasins come with a 35mm hole for a standing faucet only.

Body:	White gloss/ grafit	White gloss
Doors:	White gloss	White gloss

## Countertop Balance 600/800/1200

600 / 800 / 1200 x 465 mm

The white Balance countertop is designed for combining with Balance 500/600/800 vanity units. Placement of the washbasin and faucet on the countertop is variable. We recommend complementing the Balance countertop with Uni Slim ceramic washbasins. See p. 267.

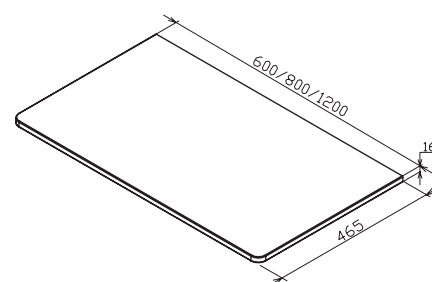

White



White

Order No.	FURNITURE	Weight (kg)	Dimensions (mm)
X000001370	Countertop Balance 600 white	4,7	600 x 465
X000001371	Countertop Balance 800 white	6,4	800 x 465
X000001372	Countertop Balance 1200 white	9,2	1200 x 465
X000001375	Countertop bracket Balance/Comfort 120	3,0	-
X000001376	Towel holder Balance white	2,0	-

## SB Balance 400

400 x 175 x 1600 mm

Tall column cabinet with six smoked glass shelves.



White



White/grafit

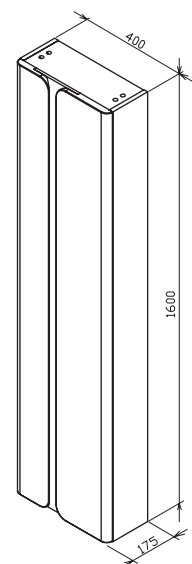

Order No.	FURNITURE	Weight (kg)	Dimensions (mm)
X000001373	SB Balance 400 white/white	25,0	400x175x1600
X000001374	SB Balance 400 white/graphite		





5-YEAR WARRANTY



ANTI-MOISTURE FINISH

## Countertop bracket Balance

The bracket supports the Balance 1200 countertop in variants with only one vanity unit.

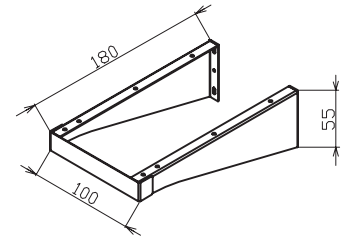

Order No.	ACCESSORIES	Weight (kg)	Dimensions (mm)
X000001375	Countertop bracket Balance/Comfort 120	3,0	100 x 180 x 55

## Towel holder Balance white

Adjustable towel holder for both the left-sided and right-sided variant; designed for the Balance 1200 countertop.

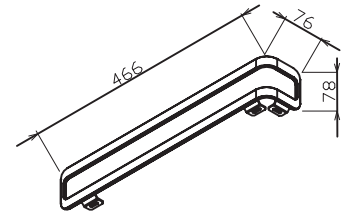

Order No.	ACCESSORIES	Weight (kg)
X000001376	Towel holder Balance white	2,0

## Waste trap with a fixed waste plug

The waste trap is designed for Balance washbasins inset in wall-mounted vanity units from the same product line.

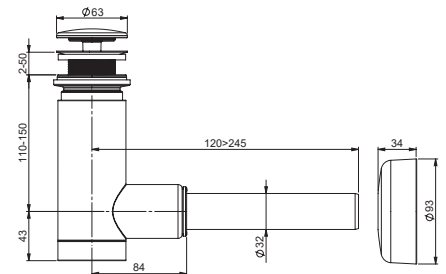

Order No.	ACCESSORIES	Weight (kg)
X01723	siphon with fixed waste plug	0,56

Furniture dimensions specified as: width x depth x height. Product weight is listed as gross, i.e. including packaging. Products are as standard delivered within 14 days.



# Variability and storage space of the Balance furniture



SD Balance two-drawer vanity units for mounting under a washbasin provide ample storage space for all your bathroom necessities. The tall sidewalls of the bottom drawer will safely hold even larger items.



Balance furniture also allows the popular countertop placement of the washbasin.



Should you need even more space, the Balance line is here to serve, offering a tall cabinet with six variable glass shelves.





Take advantage of the numerous other combinations possible with Balance furniture and build a bathroom exactly to your needs.



The placement of the faucet onto the Balance countertop is variable.



The concealed faucet allows you to make use of the entire surface of the countertop around the washbasin.

# Ceramic washbasins and Furniture Comfort



Design by Michał Roszkowski

This set combines the qualities of a ceramic washbasin with modern storage vanity unit outlines. The inset ceramic washbasin features slim edges to give the combined set an air of lightness.





The Comfort set is characterised by a semi-recessed metal handle with a unique design.



5

5-YEAR WARRANTY



ANTI-MOISTURE  
FINISH

## Washbasin Comfort 600/800 - ceramic

600 / 800 x 460 mm

The washbasin is designed for inseting into the SD Comfort vanity unit. It cannot be mounted separately to the wall and must be combined with a washbasin waste trap with a fixed waste plug.

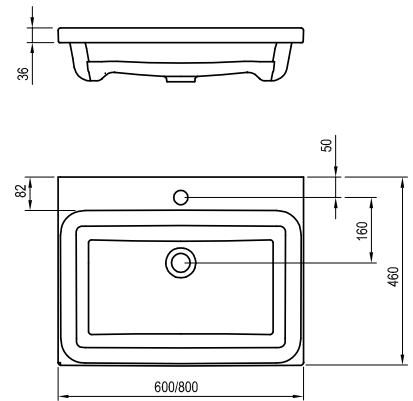

Order No.	WASHBASINS	Weight (kg)	Dimensions (mm)
XJX01260001	Comfort 600 ceramic white	14,7	600x460
XJX01280001	Comfort 800 ceramic white	16,7	800x460
Order No.	ACCESSORIES	Weight (kg)	
X01723	siphon with fixed waste plug	0,6	-

## SD Comfort 600/800

600 / 800 x 460 x 500 mm

Wall-mounted vanity unit with two drawers. Comfort cabinets come by default with a white handle which can be replaced by purchasing an additional chrome handle. When combined with the Comfort washbasin, it is necessary to use a waste trap with a fixed waste plug.



White

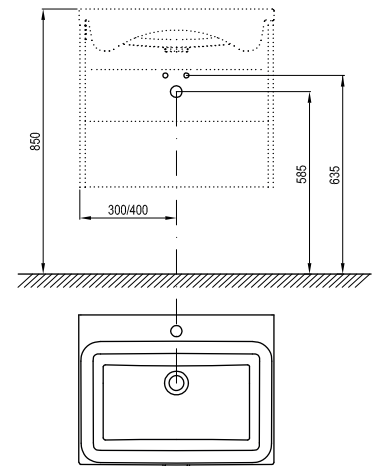
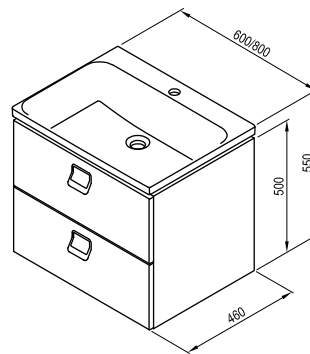

Order No.	FURNITURE	Weight (kg)	Dimensions (mm)
X000001377	SD Comfort 600 white/white	27,0	600x460x500
X000001378	SD Comfort 800 white/white	31,0	800x460x500
Order No.	ACCESSORIES	Weight (kg)	
X000001385	Handle Comfort chrome	0,2	-

Furniture dimensions specified as: width x depth x height. Product weight is listed as gross, i.e. including packaging.

Products are as standard delivered within 14 days.

Washbasins come with a 35mm hole for a standing faucet only.

Body:	White gloss
Doors:	White gloss

## Countertop Comfort 600/800/1200

600 / 800 / 1200 x 460 mm

The white Comfort countertop is designed for combining with Comfort 600/800 vanity units.

The placement of the washbasin and the faucet on the countertop is variable.

We recommend combining the Comfort countertop with ceramic Uni Slim washbasins.



White



White

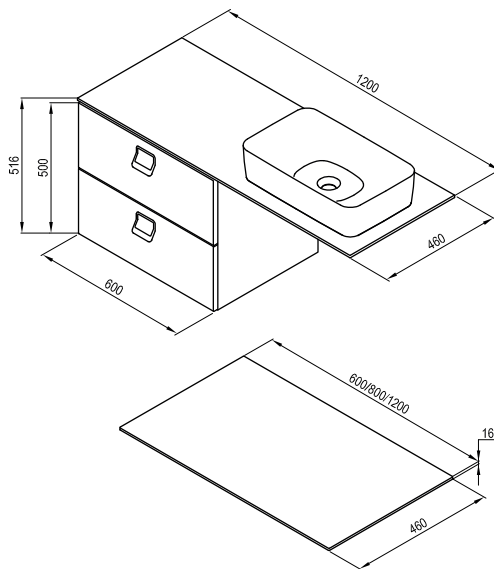

Order No.	FURNITURE	Weight (kg)	Dimensions (mm)
X000001379	Countertop Comfort 600 white	4,7	600x460
X000001380	Countertop Comfort 800 white	6,4	800x460
X000001381	Countertop Comfort 1200 white	9,2	1200x460
Order No.	ACCESSORIES	Weight (kg)	
X000001375	Countertop bracket Balance/Comfort 120	3,0	-
X000001384	Towel holder Comfort white	2,0	-

## SB Comfort 350/400

350 x 320 x 1600 mm

400 x 165 x 1600 mm

Tall column cabinet with six smoked glass shelves.

Rotating the cabinet allows you to choose between a left- or right-sided variant. Comfort cabinets come by default with a white handle which can be replaced by purchasing an additional chrome handle.



White



White

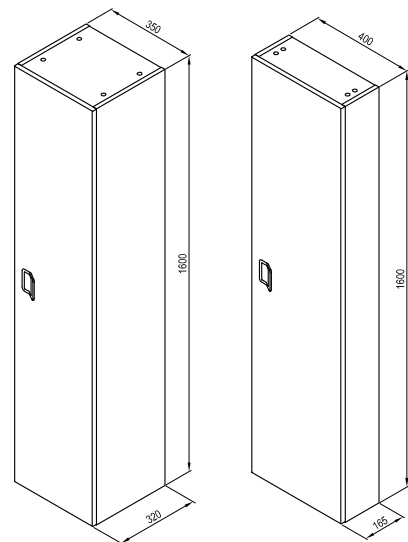

Order No.	FURNITURE	Weight (kg)	Dimensions (mm)
X000001382	SB Comfort 400 white/white	25,0	350x320x1600
X000001383	SB Comfort 350 white/white	29,4	400x165x1600
Order No.	ACCESSORIES	Weight (kg)	
X000001385	Handle Comfort chrome	0,2	



5-YEAR WARRANTY



ANTI-MOISTURE FINISH

## Countertop bracket Comfort

The bracket supports the Comfort 1200 countertop in variants with only one vanity unit.

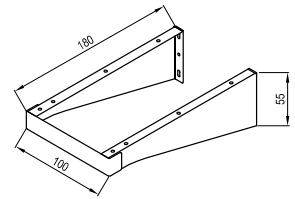

Order No.	ACCESSORIES	Weight (kg)	Dimensions (mm)
X000001375	Countertop bracket Balance/Comfort 120	3,0	100x180x55

## Handle Comfort chrome

Metal handle, semi-recessed into the front side of cabinets. A characteristic design element of the Comfort furniture line. The handle can be purchased separately to replace the white handles supplied with the cabinets.

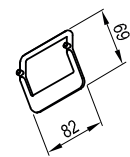

Order No.	ACCESSORIES	Weight (kg)
X000001385	Handle Comfort chrome	0,2

## Towel holder Comfort white

Towel holder for both the right- and left-sided variant of the product. Designed for the Comfort 1200 countertop.

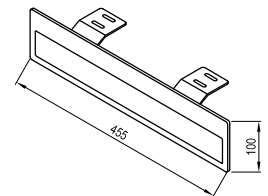

Order No.	ACCESSORIES	Weight (kg)
X000001384	Towel holder Comfort white	2,0

## Waste trap with a fixed waste plug

The waste trap is designed for Comfort washbasins inset in wall-mounted vanity units from the same product line.

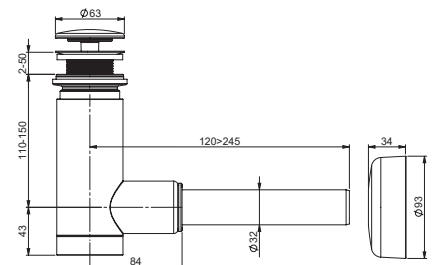

Order No.	ACCESSORIES	Weight (kg)
X01723	siphon with fixed waste plug	0,6

Furniture dimensions specified as: width x depth x height. Product weight is listed as gross, i.e. including packaging. Products are as standard delivered within 14 days.





# Variability and storage space of the Comfort furniture



SD Comfort two-drawer vanity units for mounting under a washbasin provide ample storage space for all your bathroom necessities. The tall sidewalls of the bottom drawer will safely hold even larger items.



The Comfort countertop combined with the vanity unit provides both a concealed storage space and a shelf around the washbasin.



Thanks to its two width and depth variants, the tall cabinet can accommodate varied needs for storage space.



Take advantage of the numerous other combinations possible with Comfort furniture and build a bathroom exactly to your needs.



The placement of the faucet onto the Comfort countertop is variable.



The semi-recessed handles can be matched with other bathroom fittings, such as faucets and accessories. Aside from the white design, the handles are also available in chrome.



# Furniture Step

new



Design Kryštof Nosál

Furniture set designed for countertop washbasins. The first step to a tidy bathroom. Safely and neatly stores everything you want to keep out of sight.



Veneer with natural texture and design in the style of overlapping wooden boards brings nature into your bathroom.



Maximum storage space while maintaining an elegantly delicate look.

5

5-YEAR WARRANTY



ANTI-MOISTURE FINISH

## Mirror cabinet Step

1000 x 150 x 740 mm

Openable mirror cabinet. Double-sided mirror (on both the outer and inner side of the door leaves). Two glass shelves. LED lighting at the top.

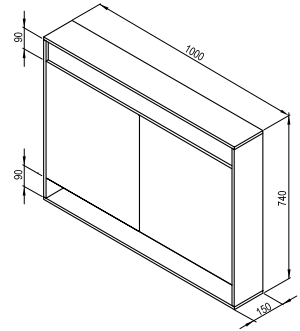

White

Order No.	FURNITURE	Weight (kg)	Dimensions (mm)
X000001421	MC Step 1000 white	22,7	1000x150x740

## SD Step

1000 x 540 x 305 mm

Vanity unit under countertop washbasins.

Pre-drilled opening for washbasin. Fully extendable drawer. White glossy body, oak/walnut veneer.

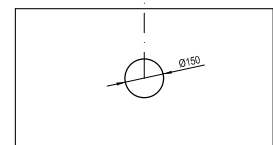
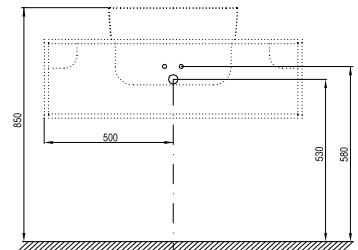
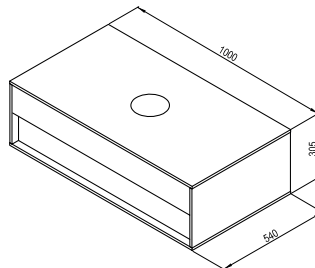

White



Walnut veneer



Oak veneer

Order No.	FURNITURE	Weight (kg)	Dimensions (mm)
X000001418	SD Step 1000 white/walnut	35,7	1000x540x305
X000001417	SD Step 1000 white/oak		
X000001429	SD Step 1000 white/white		

Furniture dimensions specified as: width x depth x height. Product weight is listed as gross, i.e. including packaging.

Products are as standard delivered within 14 days.

Note: The mirror cabinet features integrated lighting with cable for direct connection to wiring. Does not come with a plug, switch or socket.



5

5-YEAR WARRANTY



ANTI-MOISTURE FINISH

Body:	White gloss	White gloss	White gloss
Doors:	Walnut veneer	Oak veneer	White gloss

### SB Step

430 x 290 x 1600 mm  
Tall column cabinet with glass shelves.

Grey interior, white painted exterior. White glossy doors, oak/walnut veneer. Damper hinges.

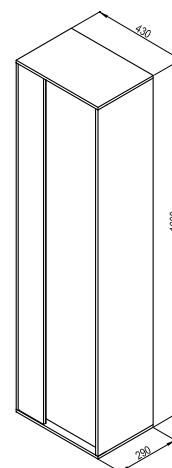

White



Walnut veneer



Oak veneer

Order No.	FURNITURE	Weight (kg)	Dimensions (mm)
X000001420	SB Step 430 white/walnut		
X000001419	SB Step 430 white/oak	32,4	430x290x1600
X000001430	SB Step 430 white/white		



Furniture dimensions specified as: width x depth x height. Product weight is listed as gross, i.e. including packaging. Products are as standard delivered within 14 days.

# Furniture Formy



Design Kryštof Nosál

Formy bathroom furniture perfectly matches the washbasins and lends the entire bathroom an elegant look.



# Vanity unit for Formy countertop washbasin



Design Kryštof Nosál

Combines a washbasin countertop with space for hidden storage of bathroom necessities. Suitable for all modern types of washbasins.





CONCEPTS  
Concept Formy



5-YEAR WARRANTY



ANTI-MOISTURE  
FINISH

Body:	Walnut veneer	Oak veneer	White gloss
Doors:	Walnut veneer	Oak veneer	White gloss

## MIRROR Formy

800 / 1000 / 1200 x 150 x 710 mm  
Mirror with handy shelf for storage.

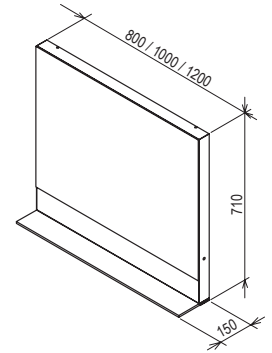

White



Walnut veneer



Oak veneer

Order No.	FURNITURE	Weight (kg)	Dimensions (mm)
X000001044	Mirror Formy 800 white	30,0	800x150x710
X000001046	Mirror Formy 800 oak		
X000001049	Mirror Formy 800 walnut		
X000000983	Mirror Formy 1000 white	37,0	1000x150x710
X000001047	Mirror Formy 1000 oak		
X000001050	Mirror Formy 1000 walnut		
X000001045	Mirror Formy 1200 white	44,0	1200x150x710
X000001048	Mirror Formy 1200 oak		
X000000984	Mirror Formy 1200 walnut		

## SB Formy

460 x 270 x 1600 mm  
Tall column cabinet with large storage space with shelves.  
Finish in white colour or two types of veneer (oak, walnut).  
The cabinet is universal and turnable, meaning it can be opened to the left or right as you choose.

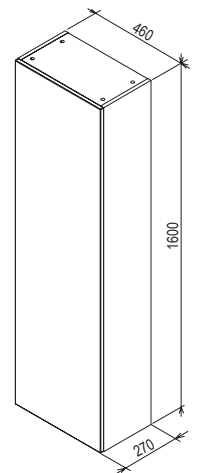

White



Walnut veneer



Oak veneer

Order No.	FURNITURE	Weight (kg)	Dimensions (mm)
X000001262	SB Formy 460 walnut	28,5	460x270x1600
X000001261	SB Formy 460 oak		
X000001260	SB Formy 460 white		

Furniture dimensions specified as: width x depth x height. Product weight is listed as gross, i.e. including packaging.  
Products are as standard delivered within 14 days.



CONCEPTS  
Concept Formy



5 5-YEAR WARRANTY



ANTI-MOISTURE  
FINISH

Body:	Walnut veneer	Oak veneer	White gloss
Doors:	Walnut veneer	Oak veneer	White gloss

## SD Formy 800

800 x 550 x 220

Vanity unit with storage space and one drawer.

Finish in white colour or two types of veneer (oak, walnut).

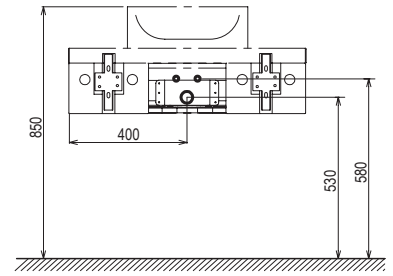
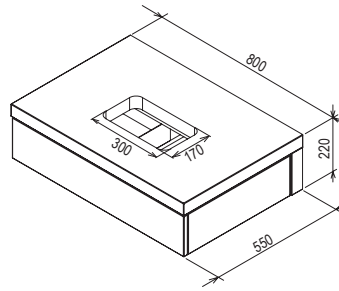

White



Walnut veneer



Oak veneer

Order No.	FURNITURE	Weight (kg)	Dimensions (mm)
X000001029	SD Formy 800 white		
X000001032	SD Formy 800 oak	37,0	800x550x220
X000001035	SD Formy 800 walnut		

## SD Formy 1000/1200

1000/1200 x 550 x 220 mm

Vanity unit with storage space and two drawers.

Finish in white colour or two types of veneer (oak, walnut).

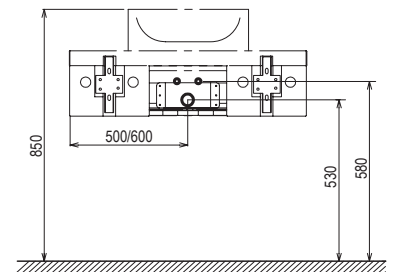
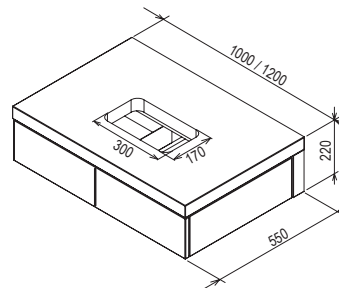

White



Walnut veneer



Oak veneer

Order No.	FURNITURE	Weight (kg)	Dimensions (mm)
X000001030	SD Formy 1000 white		
X000001033	SD Formy 1000 oak	46,0	1000x550x220
X000001036	SD Formy 1000 walnut		
X000001031	SD Formy 1200 white		
X000001034	SD Formy 1200 oak	56,0	1200x550x220
X000001037	SD Formy 1200 walnut		

## Washbasins and Furniture 10°



Design Kryštof Nosál

Bathroom furniture, the purpose of which is to enhance the aesthetic experience.





The 10° cabinets reflect the author's design of the washbasins enriching it with a generous space for storage.

For complete solution and design harmony of the bathroom, we recommend combination with the 10° bathtubs.  
▶ see p. 204

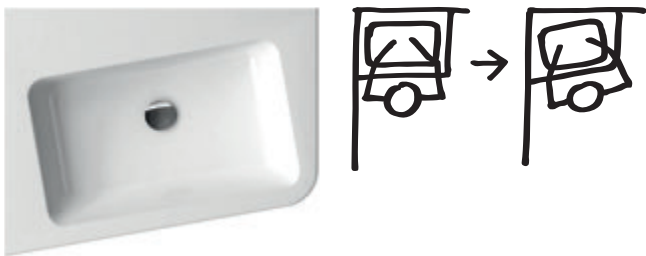

With the slight rotation of the interior space, larger storage areas were created on the washbasin.



The vanity unit for storing bathroom necessities enhanced by the author's design of the 10° concept.



reddot design award  
winner 2015





## Washbasin 10° - cast marble

550 / 650 x 450 / 480 mm

A sufficiently large washing space and comfortable shelves.

Can be combined with the SD 10° vanity unit.

See p. 294.

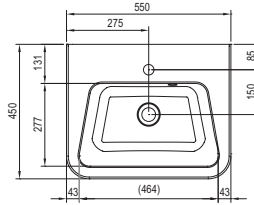
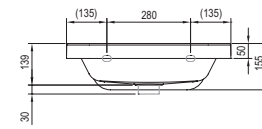

10° 550

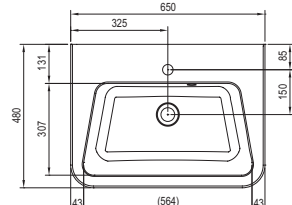
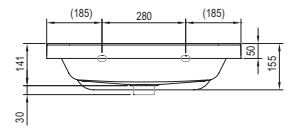

10° 650

Order No.	WASHBASINS	Weight (kg)	Dimensions (mm)
XJI01155000	10° 550 white with holes	15,7	550x450
XJI01165000	10° 650 white with holes	20,0	650x480

## Washbasin 10° Corner - cast marble

550 / 650 x 485 / 535 mm - L/R

The basin's slight rotation of 10 degrees into the space provides much greater user comfort. There is no need to be pressed against the wall, your arms can move freely during washing.

Can be combined with the SD 10° Corner vanity unit.

See p. 294.



Right-hand option

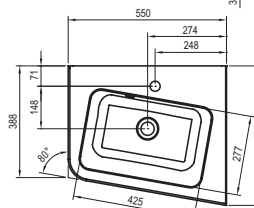
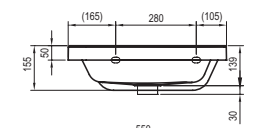

10° 550 R

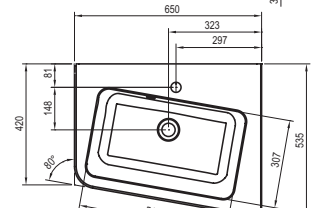
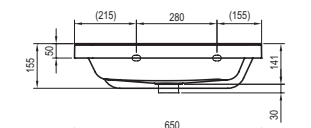

10° 650 R

Order No.	WASHBASINS	Weight (kg)	Dimensions (mm)
XJIL1155000	10° 550 L white with holes	15,4	550x485
XJIP1155000	10° 550 R white with holes		
XJIL1165000	10° 650 L white with holes	19,4	650x535
XJIP1165000	10° 650 R white with holes		

Order No.	ACCESSORIES
X01373	plug CLICK CLACK
X01437	plug ClickClack low chrome
X01436	siphon chrome U tubular
X01371	siphon chrome
X01612	Furniture siphon

See p. 341.

Body:	Laminate Dark walnut	White gloss
Doors:	Laminate Dark walnut	White gloss

## MIRROR 10° straight

550 / 650 x 110 x 750 mm  
Mirror with a useful shelf to store necessary things.

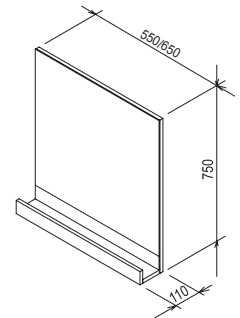

White



Dark walnut

Order No.	FURNITURE	Weight (kg)	Dimensions (mm)
X00000848	Mirror 10° 550 white	7,5	550x110x750
X00000850	Mirror 10° 550 dark walnut		
X00000851	Mirror 10° 650 white	8,5	650x110x750
X00000853	Mirror 10° 650 dark walnut		

## MIRROR 10° Corner

550 / 650 x 150 x 750 mm - L/R  
Mirror rotated by 10° towards the bathroom space to provide the user greater comfort during use. Combines beautifully with the 10° corner washbasin.

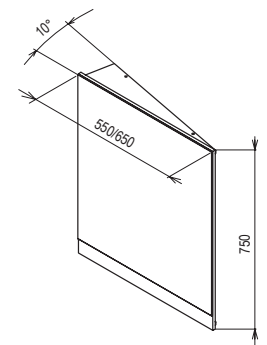

White



Dark walnut

Order No.	FURNITURE	Weight (kg)	Dimensions (mm)
X000001070	Mirror 10° 550 L white	18,0	550x150x750
X000001073	Mirror 10° 550 R white		
X000001072	Mirror 10° 550 L dark walnut		
X000001075	Mirror 10° 550 R dark walnut		
X000001076	Mirror 10° 650 L white	20,0	650x150x750
X000001079	Mirror 10° 650 R white		
X000001078	Mirror 10° 650 L dark walnut		
X000001081	Mirror 10° 650 R dark walnut		

Furniture dimensions specified as: width x depth x height. Product weight is listed as gross, i.e. including packaging.

**L (left)** - Left-hand product option, **R (right)** - right-hand product option.

Products are as standard delivered within 14 days.





CONCEPTS  
Concept 10°



5-YEAR WARRANTY



ANTI-MOISTURE FINISH

new

## SD 10°

550 / 650 x 450 / 480 x 450 mm  
The vanity unit now has two drawers to allow better arrangement of your bathroom necessities.

Designed under washbasin 10°.



White



Dark walnut

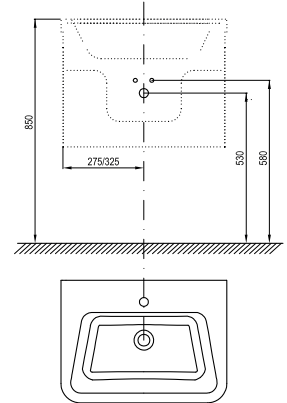
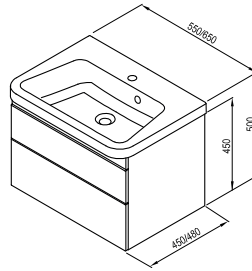

Order No.	FURNITURE	Weight (kg)	Dimensions (mm)
X000001283	SD 10° II 550 white	24,9	550x450x450
X000001285	SD 10° II 550 dark walnut		
X000001286	SD 10° II 650 white	29,4	650x480x450
X000001288	SD 10° II 650 dark walnut		

## SD 10° corner

550 / 650 x 485 / 535 x 450 mm - L/R  
Vanity unit with a shelf featuring ample storage space.

Designed for 10° corner washbasin of the same type.



White

Right-hand option



Dark walnut

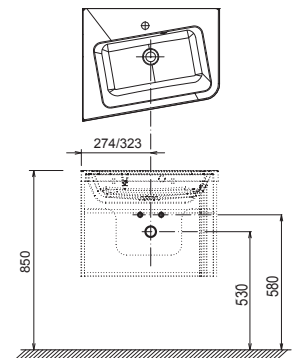
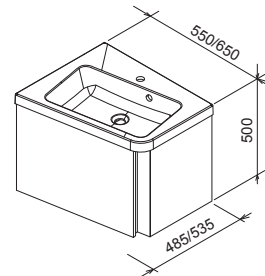

Left-hand option

Order No.	FURNITURE	Weight (kg)	Dimensions (mm)
X000000739	SD 10° 550 L white	19,0	550x485x450
X000000742	SD 10° 550 R white		
X000000741	SD 10° 550 L dark walnut		
X000000744	SD 10° 550 R dark walnut		
X000000745	SD 10° 650 L white	22,0	650x535x450
X000000748	SD 10° 650 R white		
X000000747	SD 10° 650 L dark walnut		
X000000750	SD 10° 650 R dark walnut		

Furniture dimensions specified as: width x depth x height. Product weight is listed as gross, i.e. including packaging.

**L (left)** - Left-hand product option, **R (right)** - right-hand product option.

Products are as standard delivered within 14 days.

Colour finish\*:

\* The cabinets are available in white glossy colour finish, or in the colour of dark walnut, always with an added white decorative stripe.

Body:	Laminate Dark walnut	White gloss
Doors:	Laminate Dark walnut	White gloss

**SB 10°**

450 x 290 x 1600mm  
Tall column cabinet with three shelves.

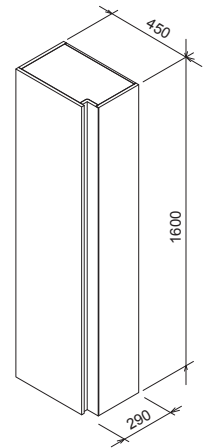

White



Dark walnut

Order No.	FURNITURE	Weight (kg)	Dimensions (mm)
X000000751	side column SB 10°450 white	29,0	450x290x1600
X000000753	Side column SB 10° 450 dark walnut		



Furniture dimensions specified as: width x depth x height. Product weight is listed as gross, i.e. including packaging. Products are as standard delivered within 14 days.

# Ceramic washbasins and Furniture Chrome



Practical two drawers for storage of bathroom equipment in furniture made of deep-impregnated material that can withstand even in the extremely humid bathroom environment.



Modern design with traditional values of quality material.



Chrome washbasins will elegantly complement other products of the Chrome range (bathtub, shower enclosure, faucets, etc).

► see p. 18



### Washbasin Chrome 550 - ceramic

550 x 470 mm  
 Can be combined with the vanity unit  
 SD Chrome II 550. See p. 298.

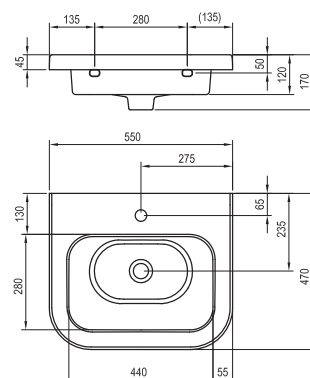

Order No.	WASHBASINS	Weight (kg)	Dimensions (mm)
XJG01155000	Chrome 550 ceramic white	14,7	550x470

### Washbasin Chrome 650 - ceramic

650 x 470 mm  
 Can be combined with the vanity unit  
 SD Chrome II 650. See p. 298.

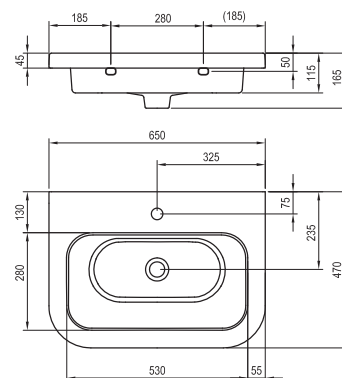

Order No.	WASHBASINS	Weight (kg)	Dimensions (mm)
XJG01165000	Chrome 650 ceramic white	17,0	650x470

Order No.	ACCESSORIES
X01373	plug CLICK CLACK
X01437	plug ClickClack low chrome
X01436	siphon chrome U tubular
X01371	siphon chrome
X01612	Furniture siphon

See p. 341.

Washbasin dimensions specified as: width x depth. Product weight is listed as gross, i.e. including packaging.  
 Washbasins come with a 35mm hole for a standing faucet only.  
 Products are as standard delivered within 14 days.



## MIRROR Chrome

600 / 700 / 800 x 70 x 550 mm  
Mirror featuring an integrated light fixture with a distinctive shape.

The mirror is designed for installation above the Chrome washbasin 600 / 700 / 800.

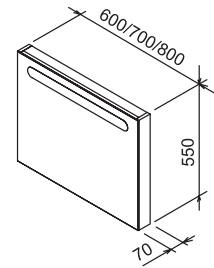

White

Order No.	FURNITURE	Weight (kg)	Dimensions (mm)
X000000546	Mirror Chrome 600 white	9,5	600x70x550
X000000548	Mirror Chrome 700 white	11,0	700x70x550
X000000550	Mirror Chrome 800 white	12,0	800x70x550

## SD Chrome II 550/650

490 / 590 x 420 x 445 / 545 mm  
Vanity unit with two pull-out drawers. The vanity units are designed for installation under the Chrome 550 / 650 ceramic washbasins.



White

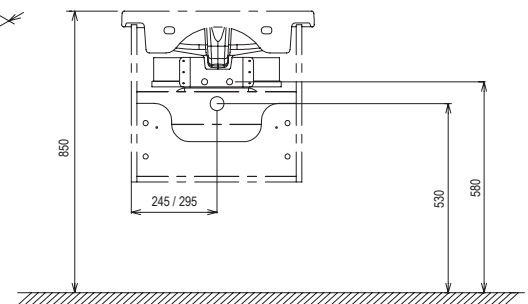
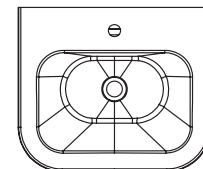
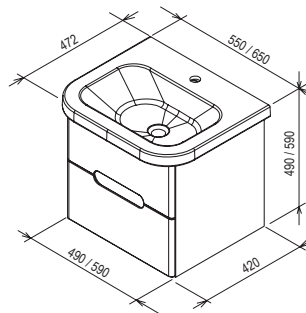

Order No.	FURNITURE	Weight (kg)	Dimensions (mm)
X000001289	SD 550 Chrome II white	21,5	490x420x445
X000001291	SD 650 Chrome II white	25,5	590x420x545

Colour finish\*:

\* the specified cabinet bodies are always in combination with white glossy doors.

Body:	White gloss	Cappuccino
Doors:	White gloss	White gloss

**SB Chrome**

**new**

390 x 290 x 1500mm - L/R  
Tall column cabinet with three glass shelves

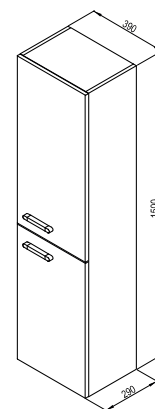

White



Cappuccino

Order No.	FURNITURE	Weight (kg)	Dimensions (mm)
X000000542	Side column SB 390 Chrome L white/white	27,5	390x290x1500
X000000543	Side column SB 390 Chrome R white/white		
X000000966	Side column SB 390 Chrome L cappuccino/white		
X000000967	Side column SB 390 Chrome R cappuccino/white		



With their unobtrusive modern design, ceramic products of the Chrome concept suit any other bathroom equipment.

Furniture dimensions specified as: width x depth x height. Product weight is listed as gross, i.e. including packaging.  
**L (left)** - Left-hand product option, **R (right)** - right-hand product option.  
 Products are as standard delivered within 14 days.



## Cast marble washbasins and Furniture Chrome



Design Kryštof Nosál

Innovated handle in the style of the Chrome concept. The designer softened the trendy slim lines with roundness typical for the whole concept.



Bathroom cabinets and mirrors Chrome were designed by the designer generously so that they are in harmony with all dimensional and type options of Chrome washbasins. Pure style and uncompromising quality of the materials used remains to be the unifying element.



Sophisticated inner layout of the vanity unit will easily take care of all cosmetics and bathroom items for the entire household. The vanity unit has two drawers for comfortable storage of even taller bathroom items.



The Chrome vanity unit line ranges from large vanity units for double washbasins to space-saving vanity units for small washbasins most commonly found in toilets.



## Washbasin Chrome - cast marble

600 / 700 / 800 x 490 mm  
Can be combined with the SD Chrome vanity units for installation under washbasin 600 / 700 / 800 and the Chrome mirror.  
See p. 304

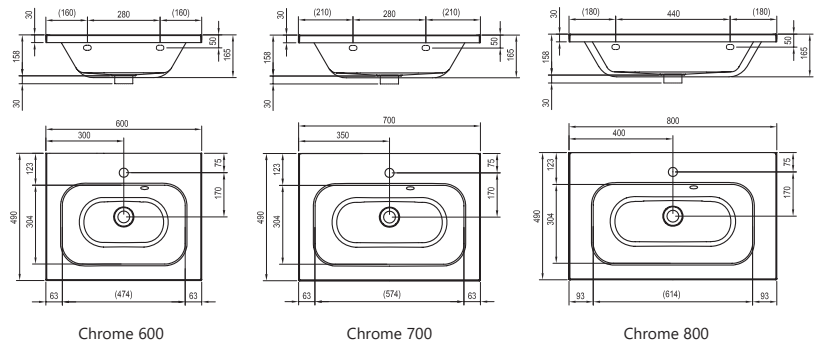

Order No.	WASHBASINS	Weight (kg)	Dimensions (mm)
XJG01160000	Chrome 600 white with holes	16,5	600x490
XJG01170000	Chrome 700 white with holes	20,0	700x490
XJG01180000	Chrome 800 white with holes	23,2	800x490

## Double washbasin Chrome - cast marble

1200 x 490 mm  
Double washbasin - maximum user comfort multiplied by two. Can be combined with the vanity unit under double washbasin SD Chrome 1200. See p. 305

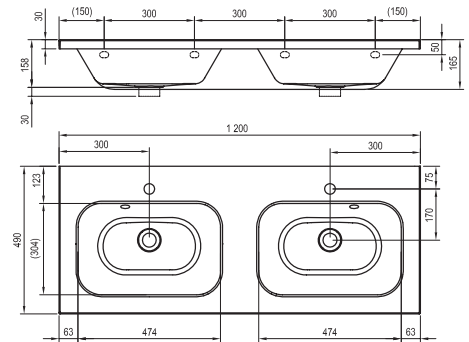

Order No.	WASHBASINS	Weight (kg)	Dimensions (mm)
XJG0112000	DoubleChrome 1200 white with holes	34,7	1200x490

Washbasin dimensions specified as: width x depth. Product weight is listed as gross, i.e. including packaging. For washbasins with a hidden overflow, use a faucet with a pull rod and a waste set. Washbasins come with a 35mm hole for a standing faucet only. Products are as standard delivered within 14 days.



## Small washbasin Chrome - cast marble

400 x 220 mm - L/R

An individual small washbasin which can be mounted onto the wall.

It does not have an overflow - it is necessary to use a fixed washbasin waste plug.

Can be complemented by the SD Chrome 400 vanity unit under small washbasin.

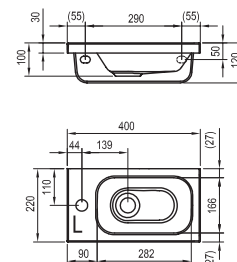

Left-hand option

Order No.	WASHBASINS	Weight (kg)	Dimensions (mm)
XJGL1100000	Small basin Chrome L white with holes	5,6	400x220
XJGP1100000	Small basin Chrome R white with holes		

Order No.	ACCESSORIES
X01373	plug CLICK CLACK
X01437	plug ClickClack low chrome
X01439	plug fixed chrome
X01695	plug fixed ceramic
X01371	siphon chrome
X01436	siphon chrome U tubular
X01612	Furniture siphon

See p. 341.



We are continuously expanding the Chrome concept with new and innovated products. Thanks to that, it is the widest collection of matching equipment and furnishings for the entire bathroom and toilet.

Washbasin dimensions specified as: width x depth. Product weight is listed as gross, i.e. including packaging.  
Washbasins come with a 35mm hole for a standing faucet only. **L (left)** - Left-hand product option, **R (right)** - right-hand product option.  
Products are as standard delivered within 14 days.



## MIRROR Chrome

600 / 700 / 800 x 70 x 550 mm

Mirror featuring an integrated light fixture with a distinctive shape.

The mirror is designed for installation above the Chrome washbasin 600 / 700 / 800.

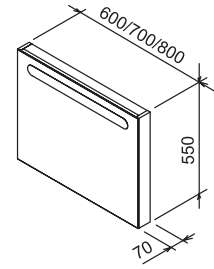

White



Cappuccino

Order No.	FURNITURE	Weight (kg)	Dimensions (mm)
X00000546	Mirror Chrome 600 white	9,5	600x70x550
X00000968	Mirror Chrome 600 cappuccino		
X00000548	Mirror Chrome 700 white	11,0	700x70x550
X00000969	Mirror Chrome 700 cappuccino		
X00000550	Mirror Chrome 800 white	12,0	800x70x550
X00000970	Mirror Chrome 800 cappuccino		

new

## SD Chrome II

600 / 700 / 800 x 490 x 500 mm

Vanity units in several sizes with two drawers. Innovated, elegantly slim handle allows comfortable opening and softens the overall look of Chrome furniture.

The vanity units are designed for installation under washbasins Chrome 600 / 700 / 800.

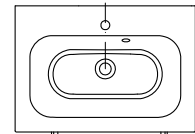
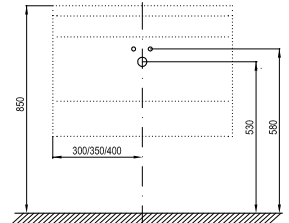
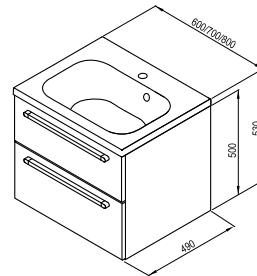

White



Cappuccino

Order No.	FURNITURE	Weight (kg)	Dimensions (mm)
X00000918	SD 600 Chrome II white/white	23,0	600x490x500
X00000919	SD 600 Chrome II cappuccino/white		
X00000920	SD 700 Chrome II white/white	25,5	700x490x500
X00000921	SD 700 Chrome II cappuccino/white		
X00000922	SD 800 Chrome II white/white	27,5	800x490x500
X00000923	SD 800 Chrome II cappuccino/white		

Furniture dimensions specified as: width x depth x height. Product weight is listed as gross, i.e. including packaging.

Products are as standard delivered within 14 days.

Note: The mirror features integrated lighting with cable for direct connection to wiring. Does not come with a plug, switch or socket.

Colour finish\*:

\* the specified cabinet bodies are always in combination with white glossy doors.

Body:	White gloss	Cappuccino
Doors:	White gloss	White gloss

new

## SD Chrome 1200

1200 x 490 x 470 mm

The vanity unit with two tall drawers is fitted with a new handle in elegantly slim design. The double washbasin with spacious drawers represents a practical and visually attractive solution for a large household.

The vanity unit is designed under the double washbasin Chrome 1200.

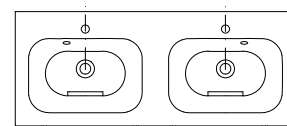
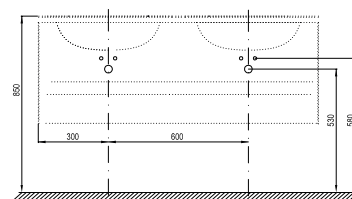
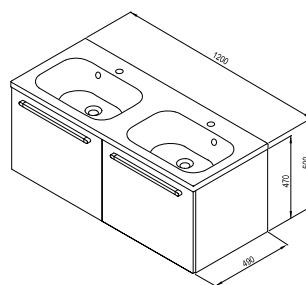

White



Cappuccino

Order No.	FURNITURE	Weight (kg)	Dimensions (mm)
X000000536	SD 1200 Chrome white/white	51,0	1200x490x470
X000000964	SD 1200 Chrome cappuccino/white		



Furniture Chrome offers everything you have come to expect from bathroom cabinets. Ample space for storage, style that does not pall even years later and durability you can rely on.

Furniture dimensions specified as: width x depth x height. Product weight is listed as gross, i.e. including packaging. Products are as standard delivered within 14 days.





CONCEPTS  
Concept Chrome



5-YEAR WARRANTY



ANTI-MOISTURE FINISH



Colour finish\*:

\* the specified cabinet bodies are always in combination with white glossy doors.

Body:	White gloss	Cappuccino
Doors:	White gloss	White gloss

new

## SD Chrome 400

400 x 220 x 470 mm  
Vanity unit with a shelf.

**The door needs to be ordered separately in either left or right hand option**

The vanity unit is designed under the small washbasin Chrome 400.

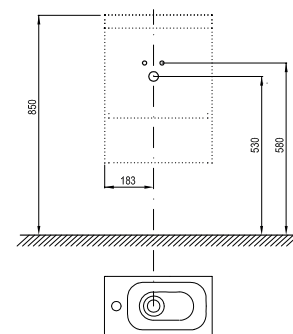
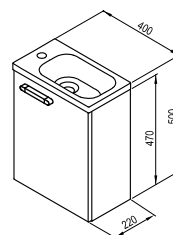

White



Cappuccino

Order No.	FURNITURE	Weight (kg)	Dimensions (mm)
X000000538	SD 400 Chrome white	6,0	400x220x470
X000000965	SD 400 Chrome cappuccino		
X000000540	Door of wash basin cabinet SD 400 Chrome L white	3,0	
X000000541	Door of wash basin cabinet SD 400 Chrome R white		

new

## SB Chrome

390 x 290 x 1500 mm - L/R  
Tall column cabinet with three glass shelves



White



Cappuccino

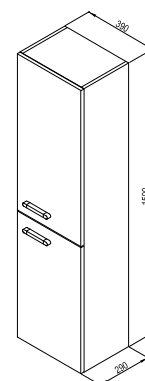

Right-hand option

Order No.	FURNITURE	Weight (kg)	Dimensions (mm)
X000000542	Side column SB 390 Chrome L white/white		
X000000543	Side column SB 390 Chrome R white/white		
X000000966	Side column SB 390 Chrome L cappuccino/white	27,5	390x290x1500
X000000967	Side column SB 390 Chrome R cappuccino/white		

Furniture dimensions specified as: width x depth x height. Product weight is listed as gross, i.e. including packaging.

**L (left)** - Left-hand product option, **R (right)** - right-hand product option.  
Products are as standard delivered within 14 days.

## Washbasins and Furniture Rosa



Design Kryštof Nosál

The Rosa washbasins are designed to offer a pleasantly large washing area, but also a sufficient storage area.





Wide range of furniture types for every bathroom where things need to be tidy and at hand.



More storage space and simple modern design of the Rosa vanity unit and basin provide versatile usage.



Colour of the cabinet bodies precisely treated with deep impregnation always give the bathroom a different style.



CONCEPTS  
Concept Rosa



5-YEAR WARRANTY



ANTI-MOISTURE FINISH

## Washbasin Rosa II 600 - cast marble

600 x 490 mm

A modern washbasin which can be combined with the SD Rosa II 600 vanity unit and Rosa II 600 mirror.

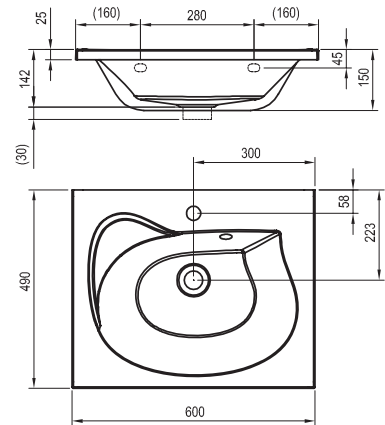

Order No.	WASHBASINS	Weight (kg)	Dimensions (mm)
XJ201160000	Wash basin Rosa 600 white with holes	15,8	600x490

## Washbasin Rosa II 760 - cast marble

760 x 490 mm

A modern washbasin which can be combined with the SD Rosa II 760 vanity unit and Rosa II 760 mirror.

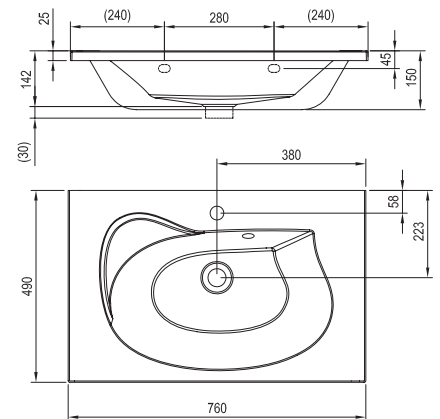

Order No.	WASHBASINS	Weight (kg)	Dimensions (mm)
XJ201176000	Rosa 760 white with holes	18,6	760x490

Order No.	ACCESSORIES
X01373	plug CLICK CLACK
X01437	plug ClickClack low chrome
X01371	siphon chrome
X01436	siphon chrome U tubular
X01612	Furniture siphon
See p. 341.	

Washbasin dimensions specified as: width x depth. Product weight is listed as gross, i.e. including packaging.  
Washbasins come with a 35mm hole for a standing faucet only.  
Products are as standard delivered within 14 days.

Colour finish\*:

\* the specified cabinet bodies are always in combination with white glossy doors.

Body:	White gloss	Laminate Cappuccino
Doors:	White gloss	White gloss

## MIRROR Rosa II 600

600 x 135 x 750 mm

The mirror is designed for installation above the washbasin Rosa II 600.

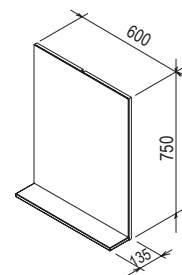

White



Cappuccino

Order No.	FURNITURE	Weight (kg)	Dimensions (mm)
X000000930	Mirror Rosa II 600 white	9,5	600x135x750
X000000932	Mirror Rosa II 600 cappuccino		

## MIRROR Rosa II 760

760 x 135 x 750 mm

Gives everything you expect from a mirror. It provides daily fast check, reflects the light and lights up the bathroom while the shelf holds the most basic cosmetics at your fingertips.

The mirror is designed for installation above the washbasin Rosa II 760.

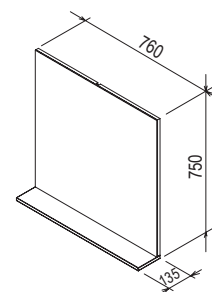

White



Cappuccino

Order No.	FURNITURE	Weight (kg)	Dimensions (mm)
X000001296	Mirror Rosa II 760 white	11,2	760x135x750
X000001298	Mirror Rosa II 760 cappuccino		

**The colour of the mirror applies to the back board, the shelf is always white!**

Furniture dimensions specified as: width x depth x height. Product weight is listed as gross, i.e. including packaging. Products are as standard delivered within 14 days.





## SD Rosa II 600

600 x 490 x 470 mm  
Vanity unit with two drawers  
designed for installation under  
the Rosa II 600 washbasin.

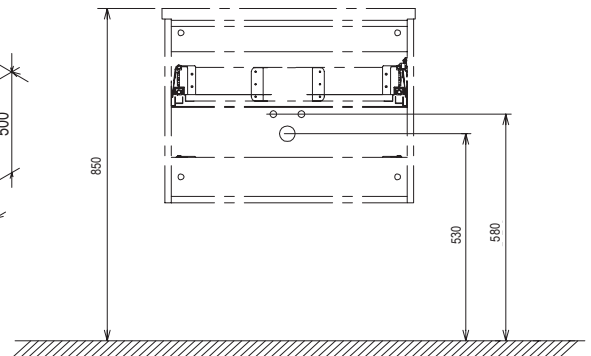
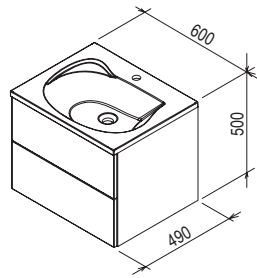

White



Cappuccino

Order No.	FURNITURE	Weight (kg)	Dimensions (mm)
X000000924	SD 600 Rosa II white/white	23,0	600x490x470
X000000926	SD 600 Rosa II cappuccino/white		

## SB Rosa II

305 x 350 x 1535 mm  
Tall column cabinet with inner  
glass shelves.

Universal use - door hinges can  
be turned over.

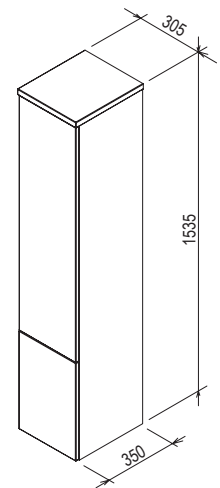

White



Cappuccino

Order No.	FURNITURE	Weight (kg)	Dimensions (mm)
X000000927	Side column SB 350 Rosa II white/white	27,5	305x350x1535
X000000929	Side column SB 350 Rosa II cappuccino/white		

Cabinet colour finish\*:  
 \* the specified cabinet bodies are always  
 in combination with white glossy doors.

Body:	White gloss	Laminate Cappuccino
Doors:	White gloss	White gloss

## SD ROSA II 760

760 x 490 x 470 mm  
 Vanity unit with two drawers designed  
 for installation under the Rosa II 760  
 washbasin.

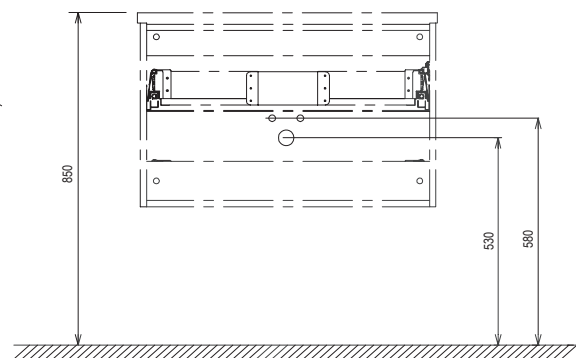
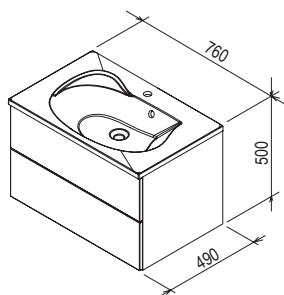

White



Cappuccino

Order No.	FURNITURE	Weight (kg)	Dimensions (mm)
X000001293	SD 760 Rosa II white/white	27,7	760x490x470
X000001295	SD 760 Rosa II cappuccino/white		



Furniture dimensions specified as: width x depth x height. Product weight is listed as gross, i.e. including packaging. Products are as standard delivered within 14 days.

## Washbasins and Furniture Classic



Design Kryštof Nosál

Spacious shelves and nicely deep washing space make any use of the washbasin a pleasant experience.





Furniture from the Classic line comes in three different colour designs, white, latte or cappuccino, always in combination with white glossy doors.

Tall column cabinets with two glass shelves and a practical drawer inside make up a compact design unity with ergonomic recess for comfortable grip.



Plenty of space for all you need to store enclosed in a modern and practical shape.



## Washbasin Classic - cast marble

600 / 700 x 490 mm

Can be combined with the SD Classic 600 / 700 vanity units and the Classic 600 / 700 mirror.

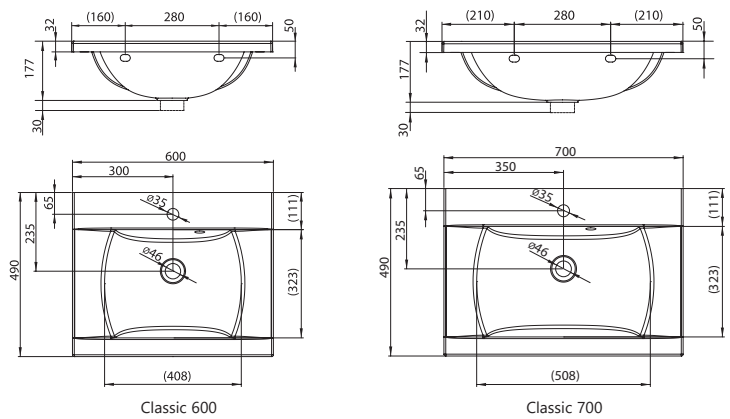

Order No.	WASHBASINS	Weight (kg)	Dimensions (mm)
XJD01160000	Classic 600 white with holes	17,9	600x490
XJD01170000	Classic 700 white with holes	20,5	700x490

## Washbasin Classic - cast marble

800 x 490 mm - L/R

Large shelf space. Can be combined with the SD Classic 800 vanity units of the same variant and the Classic 800 mirror.



Right-hand option

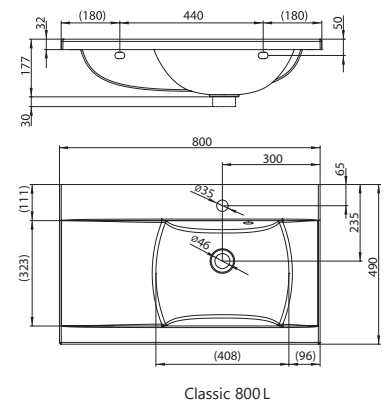

Order No.	WASHBASINS	Weight (kg)	Dimensions (mm)
XJDL1180000	Classic 800 L white with holes	22,0	800x490
XJDP1180000	Classic 800 R white with holes		

## Double washbasin Classic - cast marble

1300 x 490 mm

Double washbasin with many shelf spaces for comfortable washing.

Can be combined with the SD Classic 1300 vanity unit under double washbasin.

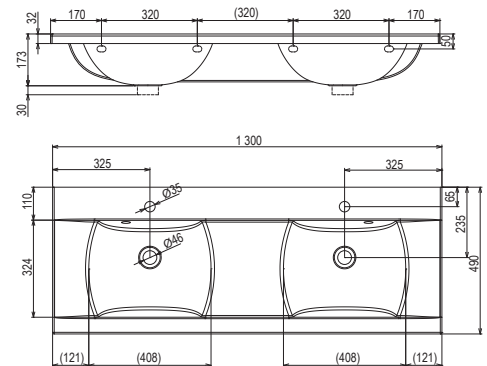

Order No.	WASHBASINS	Weight (kg)	Dimensions (mm)
XJD01113000	DoubleClassic 1300 white with holes	36,8	1300x490

Washbasin dimensions specified as: width x depth. Product weight is listed as gross, i.e. including packaging. Washbasins come with a 35mm hole for a standing faucet only. **L (left)** - Left-hand product option, **R (right)** - right-hand product option. Products are as standard delivered within 14 days.

## Small washbasin Classic - cast marble

400 x 220 mm

Can be combined with the SD Classic 400 vanity unit and washbasin tubular waste trap.

The Classic small washbasin can also be mounted onto the wall using metal chromium-plated brackets.

It does not have an overflow - it is necessary to use a fixed washbasin waste plug.

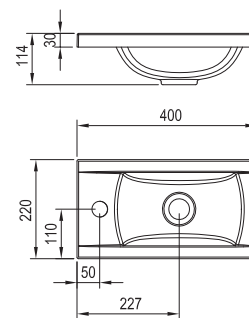

## Brackets Classic

Can be mounted onto the Classic small washbasin 400 x 220 mm

Order No.	WASHBASINS	Weight (kg)	Dimensions (mm)
XJD01140000	Small basin Classic 400 white with holes	3,9	400x220

Order No.	ACCESSORIES
X01373	plug CLICK CLACK
X01437	plug ClickClack low chrome
X01371	siphon chrome
X01436	siphon chrome U tubular
X01612	Furniture siphon
B14000100P	Bracket for CLASSIC 400 2 piece

See p. 341.



Washbasin dimensions specified as: width x depth. Product weight is listed as gross, i.e. including packaging.  
Washbasins come with a 35mm hole for a standing faucet only.  
Products are as standard delivered within 14 days.





## MIRROR Classic

600 / 700 / 800 x 70 x 550 mm  
Mirror with integrated light.

The mirror is designed for installation above the washbasin  
Classic 600 / 700 / 800.

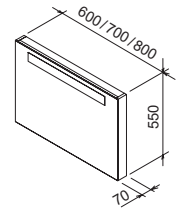

White



Cappuccino



Latte

Order No.	FURNITURE	Weight (kg)	Dimensions (mm)
X000000352	Mirror Classic 600 white	9,5	600x70x550
X000000938	Mirror Classic 600 latte		
X000000953	Mirror Classic 600 cappuccino		
X000000353	Mirror Classic 700 white	11,0	700x70x550
X000000939	Mirror Classic 700 latte		
X000000954	Mirror Classic 700 cappuccino		
X000000354	Mirror Classic 800 white	12,0	800x70x550
X000000940	Mirror Classic 800 latte		
X000000955	Mirror Classic 800 cappuccino		

## SD Classic II

600 / 700 / 800 x 490 x 600 mm  
(SD Classic II 800 - L/R)

The vanity units with two drawers are designed for installation under the Classic 600 / 700 / 800 washbasins. SD Classic II 800 is available in right- or left-sided variant adapted for the same variant of the Classic 800 (L/R) washbasin.

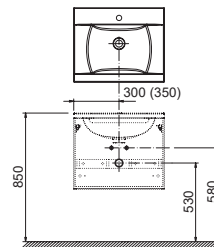
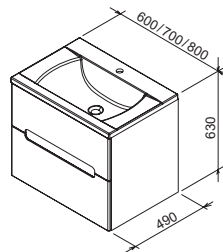

SD Classic II 600 (700)

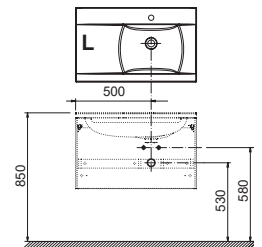

SD Classic II 800 L



White



Cappuccino



Latte

Order No.	FURNITURE	Weight (kg)	Dimensions (mm)
X000000902	SD 600 Classic II white/white	23,0	600x490x600
X000000904	SD 600 Classic II latte/white		
X000000905	SD 600 Classic II cappuccino/white		
X000000906	SD 700 Classic II white/white	25,5	700x490x600
X000000908	SD 700 Classic II latte/white		
X000000909	SD 700 Classic II cappuccino/white		
X000000910	SD 800-L Classic II white/white	27,5	800x490x600
X000000912	SD 800-L Classic II latte/white		
X000000913	SD 800-L Classic II cappuccino/white		
X000000914	SD 800-R Classic II white/white		
X000000916	SD 800-R Classic II latte/white		
X000000917	SD 800-R Classic II cappuccino/white		

Furniture dimensions specified as: width x depth x height. Product weight is listed as gross, i.e. including packaging.

Products are as standard delivered within 14 days. **L (left)** - Left-hand product option, **R (right)** - right-hand product option.

Note: The mirror features integrated lighting with cable for direct connection to wiring. Does not come with a plug, switch or socket.

Cabinet colour finish\*:

\* the specified cabinet bodies are always in combination with white glossy doors.

Body:	Laminate White	Laminate Cappuccino	Laminate Latte
Doors:	White gloss	White gloss	White gloss

## SD Classic

1300 x 490 x 470 mm

Vanity unit equipped with two high drawers (40 cm).

The right hand part under the washbasin features an integrated drawer for small items.

The vanity unit is designed under the double washbasin Classic 1300.

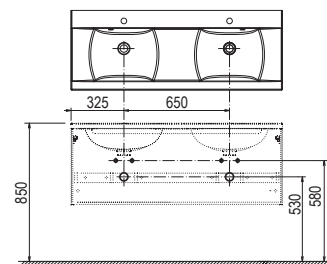
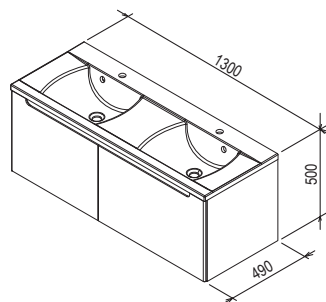

White



Cappuccino



Latte

Order No.	FURNITURE	Weight (kg)	Dimensions (mm)
X000000422	SD 1300 Classic cabinet white/white		
X000000943	SD 1300 Classic cabinet latte/white	52,0	1300x490x470
X000000958	SD 1300 Classic cabinet cappuccino/white		



Furniture dimensions specified as: width x depth x height. Product weight is listed as gross, i.e. including packaging. Products are as standard delivered within 14 days.



CONCEPTS  
Concept Classic



5-YEAR WARRANTY



ANTI-MOISTURE FINISH



The Classic concept serves perfectly in bathrooms and toilet rooms.  
Without compromise in design or utility.



Cabinet colour finish\*:

\* the specified cabinet bodies are always in combination with white glossy doors.

Body:	Laminate White	Laminate Cappuccino	Laminate Latte
Doors:	White gloss	White gloss	White gloss

## SD Classic 400

400 x 220 x 500 mm - L/R  
Vanity unit with a shelf.

**The door must be ordered separately in either a left- or right-sided variant, defined by the hinges.**

The vanity unit is designed under the small washbasin Classic.

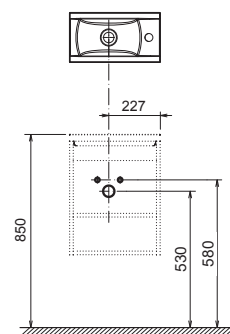
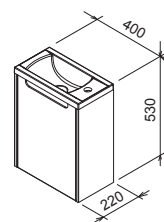

White



Cappuccino



Latte

Order No.	FURNITURE	Weight (kg)	Dimensions (mm)
X000000416	SD 400 Classic body of cabinet white		
X000000944	SD 400 Classic body of cabinet latte	10,0	400x220x500
X000000959	SD 400 Classic body of cabinet cappuccino		
X000000420	SD 400 Classic door of cabinet L white	2,0	
X000000421	SD 400 Classic door of cabinet R white		

## SB Classic

350 x 370 x 1200 mm - L/R  
Tall column cabinet with two glass shelves and a handy drawer at the top.

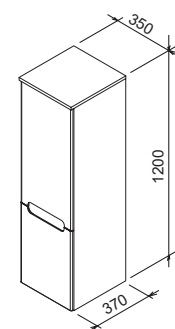

White



Cappuccino



Latte

Order No.	FURNITURE	Weight (kg)	Dimensions (mm)
X000000356	Side column SB-350 Classic L white/white		
X000000355	Side column SB-350 Classic R white/white		
X000000941	Side column SB-350 Classic L latte/white	27,5	350x370x1200
X000000942	Side column SB-350 Classic R latte/white		
X000000956	Side column SB-350 Classic L cappuccino/white		
X000000957	Side column SB-350 Classic R cappuccino/white		

Furniture dimensions specified as: width x depth x height. Product weight is listed as gross, i.e. including packaging.

**L (left)** - Left-hand product option, **R (right)** - right-hand product option.

Products are as standard delivered within 14 days.

# Washbasins and Furniture Clear



Horizontal line of the washbasin follows the wall and does not extend into the space. The longitudinal orientation provides freedom of movement for the arms. Timelessly simple style matched with furniture.



The Clear noble washbasins and cabinets with 45° precision bevelled edges, veneered surface and trendy horizontal lines give the bathroom a luxurious look.



The elegant impression is emphasized by the fine bar.



Genuine ash veneer in a cherry shade gives the bathroom a touch of cosy luxury.





5-YEAR WARRANTY



ANTI-MOISTURE FINISH

## Washbasin Clear - cast marble

800 / 1000 x 380 mm

The washbasin cannot be installed onto the wall separately. Installation is possible only with the same size of vanity unit. The washbasin needs to be equipped with the fixed washbasin waste plug.

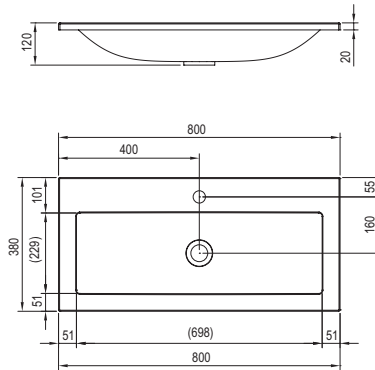

Clear 800

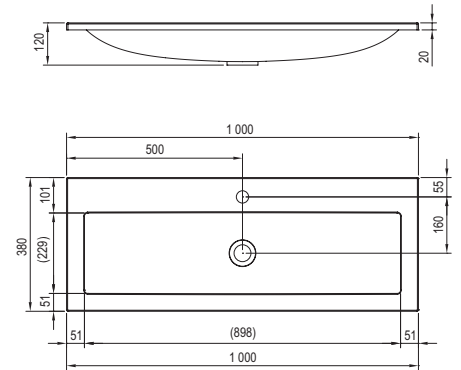

Clear 1000

Order No.	WASHBASINS	Weight (kg)	Dimensions (mm)
XJJ01180000	Clear 800 white with holes	8,8	800x380
XJJ01110000	Clear 1000 white with holes	10,8	1000x380

Order No.	ACCESSORIES
X01439	plug fixed chrome
X01695	plug fixed ceramic
X01371	siphon chrome
X01436	siphon chrome U tubular
X01612	Furniture siphon

See p. 341.

## MIRROR Clear

800 / 1000 x 440 mm

Mirror with an integrated light.  
Designed to be installed above the Clear washbasin.

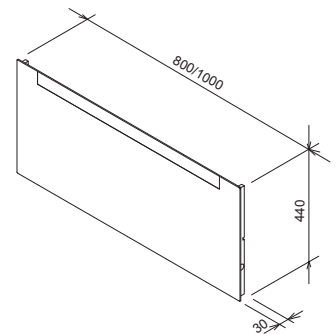

White

Order No.	FURNITURE	Weight (kg)	Dimensions (mm)
X000000765	Mirror Clear 800	6,0	800x30x440
X000000766	Mirror Clear 1000	7,0	1000x30x440

Washbasin dimensions specified as: width x depth. Product weight is listed as gross, i.e. including packaging. Washbasins come with a 35mm hole for a standing faucet only.

Products are as standard delivered within 14 days.

Note: The mirror features integrated lighting with cable for direct connection to wiring. Does not come with a plug, switch or socket.

Colour finish\*:

\* The cabinet doors are in white or cherry, always in combination with a white side decor.

Body:	White gloss	White gloss
Doors:	Cherry veneer	White gloss

### SD Clear

800 / 1000 x 380 x 400 mm

The vanity unit creates a longitudinal, horizontal look finely emphasised by a delicate bar and does not intrude into the bathroom space.

The vanity unit is designed for a Clear washbasin of the same size.

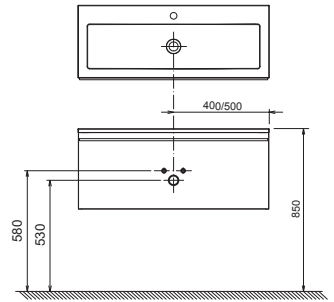
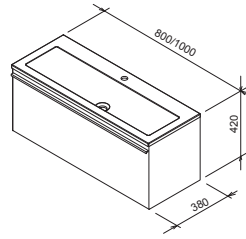

White



Cherry veneer

Order No.	FURNITURE	Weight (kg)	Dimensions (mm)
X000000757	SD 800 Clear white/white	29,0	800x380x400
X000000758	SD 800 Clear white/cherry		
X000000759	SD 1000 Clear white/white	34,0	1000x380x400
X000000760	SD 1000 Clear white/cherry		

### SB Clear

400 x 350 x 1550 mm - L/R

The double door along with the inner drawer provide a pleasantly partitioned space for the placement of items of various sizes.

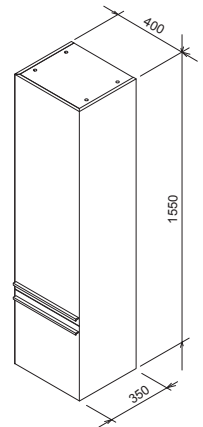

White



Cherry veneer

Order No.	FURNITURE	Weight (kg)	Dimensions (mm)
X000000761	SB-400 L Clear white/white	33,0	400x350x1550
X000000763	SB-400 R Clear white/white		
X000000762	SB-400 L Clear white/cherry		
X000000764	SB-400 R Clear white/cherry		

Furniture dimensions specified as: width x depth x height. Product weight is listed as gross, i.e. including packaging.

**L (left)** - Left-hand product option, **R (right)** - right-hand product option.

Products are as standard delivered within 14 days.

## Washbasins and Furniture Natural



Provides space for custom combinations of open areas and closed storage space. Its use with the cast marble washbasin will bring design harmony.





The Natural vanity unit for double washbasin offers large storage space that can hold all the cosmetics and bathroom necessities for the entire household.



We expanded our assortment of Natural furniture by adding two wall-mounted cabinets in open or closed design for comfortable storage of bathroom items.



Perfect, comfortable solution for couples.



5-YEAR WARRANTY



ANTI-MOISTURE FINISH

### Washbasin Natural 500 - cast marble

500 x 450 mm

A practical washbasin that does not take up much space from the wall and is therefore also suitable for smaller bathrooms. The interior washing space is perfectly comfortable for one person and the rear rim is wide enough for convenient storage of items.

The washbasin needs to be equipped with the fixed washbasin waste plug.

The washbasin is mounted directly to the wall or in combination with SD Natural 500 vanity unit.

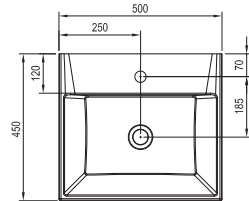
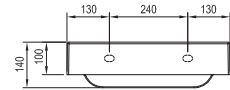

Order No.	WASHBASINS	Weight (kg)	Dimensions (mm)
XJO01250000	NATURAL 500 white without overflow	15,8	500x450

### Washbasin Natural 800 - cast marble

800 x 450 mm

Its exceptional width provides maximum comfort during washing while the longitudinal lines take up no extra bathroom space.

The washbasin needs to be equipped with the fixed washbasin waste plug.

The washbasin is mounted directly to the wall or in combination with SD Natural 800 vanity unit.

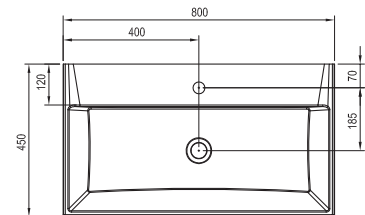
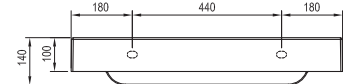

Order No.	WASHBASINS	Weight (kg)	Dimensions (mm)
XJO01280000	NATURAL 800 white without overflow	23,7	800x450

Washbasin dimensions specified as: width x depth. Product weight is listed as gross, i.e. including packaging. Washbasins come with a 35mm hole for a standing faucet only. Products are as standard delivered within 14 days.

Body:	White gloss
Doors:	White gloss

## Washbasin Natural Duo - cast marble

1200 x 450 mm

A solitaire among washbasins which gives a new dimension to joined use of the bathroom.

The joined washing area is easy to keep clean and requires only one drain.

The washbasin needs to be equipped with the fixed washbasin waste plug. The washbasin is mounted directly to the wall or in combination with SD Natural 1200 vanity unit.

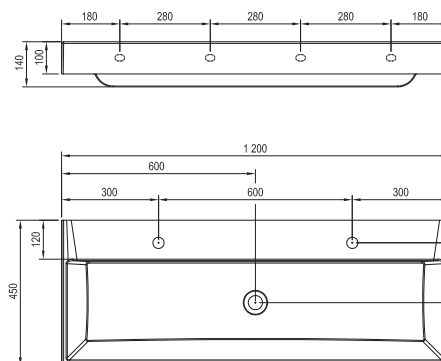

Order No.	WASHBASINS	Weight (kg)	Dimensions (mm)
XJO01212000	NATURAL DUO 1200 white without overflow	34,4	1200x450

Order No.	ACCESSORIES
X01439	plug fixed chrome
X01695	plug fixed ceramic
X01371	siphon chrome
X01436	siphon chrome U tubular
X01612	Furniture siphon

See p. 341.

## MIRROR Natural

500 / 800 / 1200 x 50 x 770 mm

The mirror is designed for installation above washbasins Natural 500/800/1200.

The Natural mirror is equipped with integrated lighting.

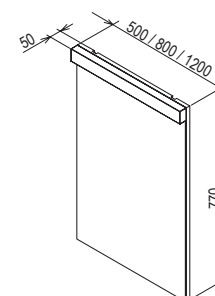

White

Order No.	FURNITURE	Weight (kg)	Dimensions (mm)
X000001056	Mirror Natural 500 white	11,0	500x50x770
X000001057	Mirror Natural 800 white	15,0	800x50x770
X000001058	Mirror Natural 1200 white	21,0	1200x50x770

Washbasin dimensions specified as: width x depth. Furniture dimensions specified as: width x depth x height. Product weight is listed as gross, i.e. including packaging.

Washbasins come with a 35mm hole for a standing faucet only.

Products are as standard delivered within 14 days.

Note: The mirror features integrated lighting with cable for direct connection to wiring. Does not come with a plug, switch or socket.



5

5-YEAR WARRANTY



ANTI-MOISTURE FINISH

## SD Natural

500 / 800 x 450 x 450 mm  
Vanity unit with large storage space and two drawers.

Designed under washbasin  
Natural 500/800.

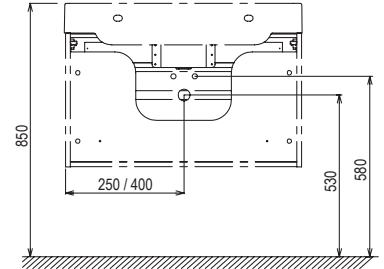
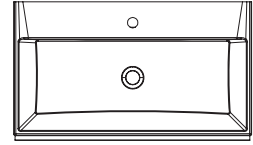
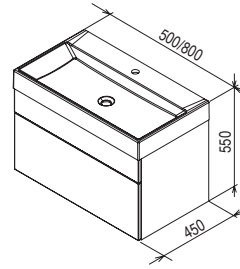

White

Order No.	FURNITURE	Weight (kg)	Dimensions (mm)
X000001051	SD Natural 500 white	30,0	500x450x450
X000001052	SD Natural 800 white	37,0	800x450x450

## SD Natural 1200

1200 x 450 x 450 mm  
Vanity unit with large storage space and two drawers.

Designed under washbasin  
Natural 1200.

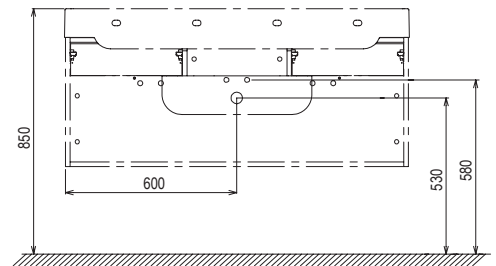
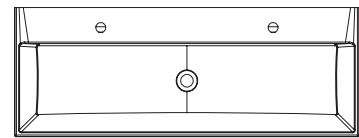
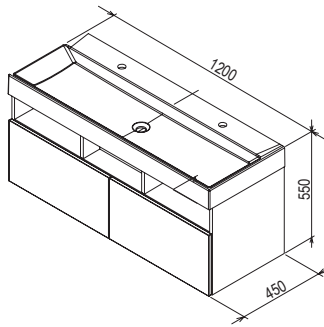

White

Order No.	FURNITURE	Weight (kg)	Dimensions (mm)
X000001053	SD Natural 1200 white	60,0	1200x450x450

Furniture dimensions specified as: width x depth x height. Product weight is listed as gross, i.e. including packaging.  
Products are as standard delivered within 14 days.

Body:	White gloss
Doors:	White gloss

### SB Natural open

450 x 260 x 550 mm  
 Tall cabinet with wooden shelf.  
 Compact and austere cabinet designed  
 for wall-mounted installation.

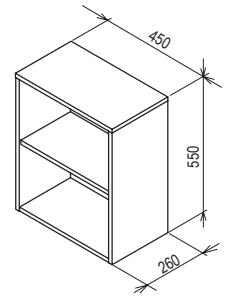

White

Order No.	FURNITURE	Weight (kg)	Dimensions (mm)
X000001055	SB Natural 450 open white	15,0	450x260x550

### SB Natural closed

450 x 280 x 770 mm  
 Tall cabinet with wooden shelf.  
 Rotating the cabinet allows you to choose  
 between left- or right-sided variant.

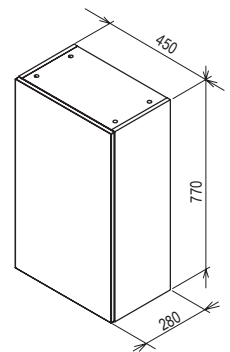

White

Order No.	FURNITURE	Weight (kg)	Dimensions (mm)
X000001054	SB Natural 450 white	12,0	450x280x770

Furniture dimensions specified as: width x depth x height. Product weight is listed as gross, i.e. including packaging. Products are as standard delivered within 14 days.

## Washbasins and Furniture BeHappy II



Design Kryštof Nosál

Simple and smart solution even for the smallest spaces. Convenient washing right above the bathtub does not take up any extra centimetres.





It provides the opportunity to store a lot of things, even in a smaller bathroom.



Harmony in practical and aesthetic requirements . The vanity unit provides storage space and its style fits the bathtub. It does not dominate the bathroom space, but fits it perfectly.



The furniture is delivered assembled; just hang it on the wall and use it.



## Washbasin BeHappy II Corner - cast marble

500 x 665 mm - L/R

Washbasins in fresh design matching the more modern outlines of bathtubs. The technologically advanced material cast marble lends the washbasins absolutely smooth and precisely defined storage surfaces.



Right-hand option



Left-hand option

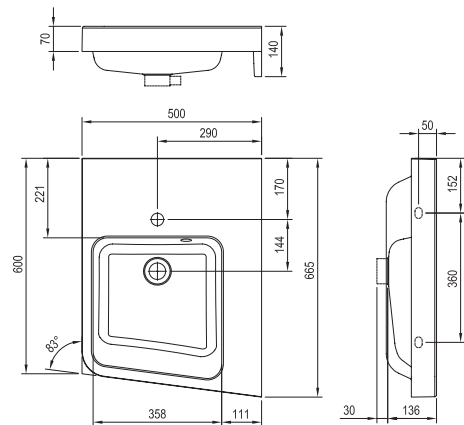

Right-hand option

Order No.	WASHBASINS	Weight (kg)	Dimensions (mm)
XJAL1100001	BeHappy II L white with holes	19,7	500x665
XJAP1100001	BeHappy II R white with holes		

Order No.	ACCESSORIES
X01437	plug ClickClack low chrome
X01436	siphon chrome U tubular
See p. 341.	

## Washbasin BeHappy II - cast marble

550 x 400 mm

It will serve perfectly anywhere in the bathroom and allows combining with a bathroom vanity unit to lend the BeHappy II concept new storage space.

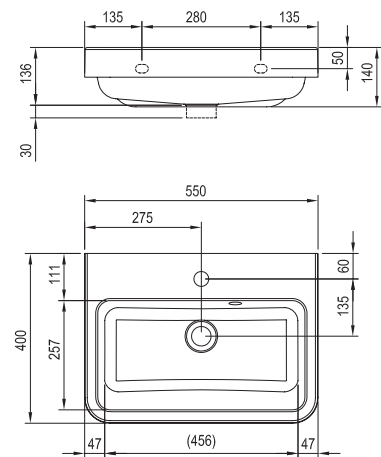

Order No.	WASHBASINS	Weight (kg)	Dimensions (mm)
XJA01155000	BeHappy II 550 white with holes	15,6	550x400

Order No.	ACCESSORIES
X01437	plug ClickClack low chrome
X01436	siphon chrome U tubular
X01612	Furniture siphon
See p. 341.	

Washbasin dimensions specified as: width x depth. Product weight is listed as gross, i.e. including packaging. Washbasins come with a 35mm hole for a standing faucet only.

**L (left)** - Left-hand product option, **R (right)** - right-hand product option.  
Products are as standard delivered within 14 days.

Body:	White gloss
Doors:	White gloss

## MIRROR BeHappy II

530 x 110 x 740 mm  
Mirror with a handy shelf designed for installation above the BeHappy II washbasin.

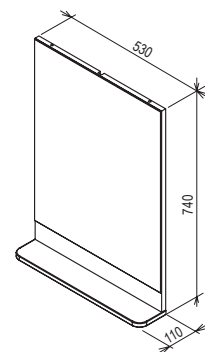

White

Order No.	FURNITURE	Weight (kg)	Dimensions (mm)
X000001099	Mirror BeHappy 530 white	12,0	530x110x740

## SD BeHappy II

530 x 370 x 435 mm  
Vanity unit with a practical drawer designed for installation under the straight washbasin BeHappy II.

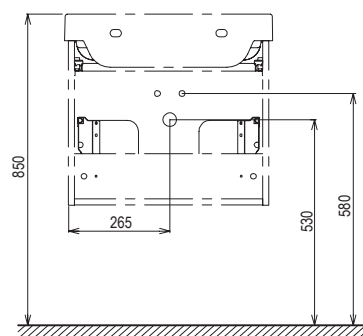
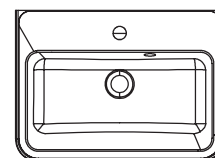
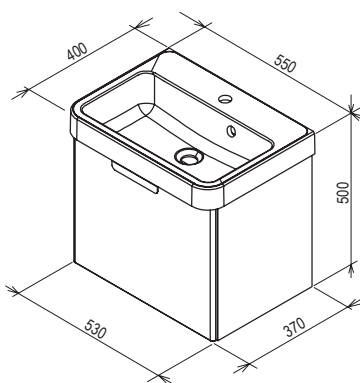

White

Order No.	FURNITURE	Weight (kg)	Dimensions (mm)
X000001097	SD BeHappy 530 white	15,5	530x370x435

Furniture dimensions specified as: width x depth x height. Product weight is listed as gross, i.e. including packaging. Products are as standard delivered within 14 days.



# Washbasins Avocado



Design Achim Storz

Even a small bathroom can have large storage area. Washbasin placed over the bathtub saves space and offers convenient use.



CONCEPTS  
Concept Avocado

5

5-YEAR WARRANTY

## Washbasin Avocado - cast marble

850 x 450 mm - L/R

The washbasin features generous shelf space and perfectly harmonises with the Avocado bathtub, creating a beautiful combination.

When mounted above the narrow part of the bathtub, the washbasin takes up minimum space.

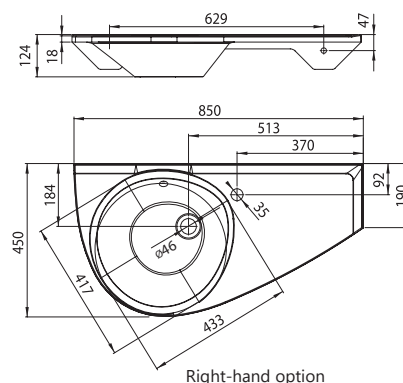

Order No.	WASHBASINS	Weight (kg)	Dimensions (mm)
XJ1L1100000	Wash basin Avocado L white with holes	13,6	850x450
XJ1P1100000	Wash basin Avocado R white with holes		

## Washbasin Avocado Comfort - cast marble

950 x 530 mm - L/R

The washbasin provides even more shelf space and comfort for washing.

This washbasin is also designed for installation above the Avocado bathtub.

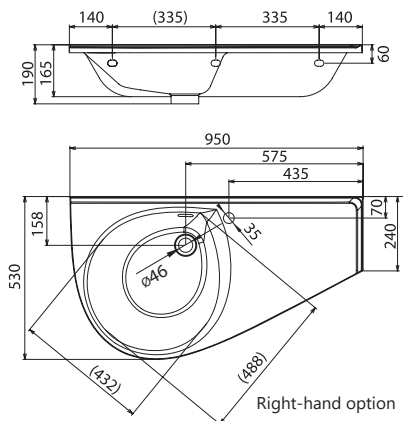

Order No.	WASHBASINS	Weight (kg)	Dimensions (mm)
XJ9L1100000	Wash basin Avocado Comfort L white	20,1	950x530
XJ9P1100000	Wash basin Avocado Comfort R white		

Order No.	ACCESSORIES
X01373	plug CLICK CLACK
X01437	plug ClickClack low chrome
X01371	siphon chrome
X01436	siphon chrome U tubular
See p. 341.	

Washbasin dimensions specified as: width x depth. Product weight is listed as gross, i.e. including packaging. Washbasins come with a 35mm hole for a standing faucet only.

**L (left)** - Left-hand product option, **R (right)** - right-hand product option.  
Products are as standard delivered within 14 days.

## Vanity unit Veda and ceramic small washbasin Veda Slim



The small washbasin can be installed with the faucet either on the right or the left. The washbasin and the compact vanity unit together form a practical whole that will allow you to wash your hands even in the smallest rooms.



5

5-YEAR WARRANTY

ANTI-MOISTURE  
FINISH

Body:	White gloss
Doors:	White gloss

## Small washbasin Veda Slim - ceramic

400 x 220 mm

Small washbasin made of thin-walled ceramic. The slender edges give more space for washing. Ideal for rooms that cannot fit a classic washbasin. The small washbasin is designed for the Veda vanity unit and cannot be mounted separately.

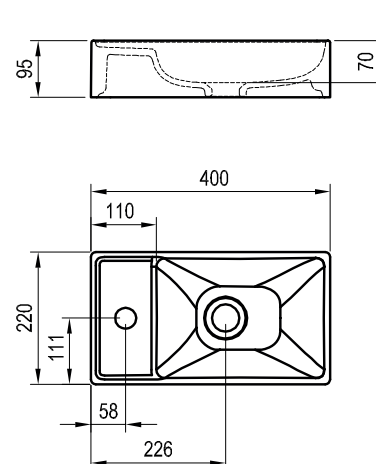

Order No.	SMALL WASHBASIN	Weight (kg)	Dimensions (mm)
XJX01240000	VEDA Slim 400 ceramic white	4,6	400x220
Order No.	ACCESSORIES	Weight (kg)	
X01439	plug fixed chrome	0,4	-
X01695	plug fixed ceramic	0,3	-
X01436	siphon chrome U tubular	0,4	-

See p. 341.

## SD Veda 400

400 x 220 x 450 mm

Vanity unit designed for placement under the Veda small washbasin.

The doors can be mounted either on the right or the left side.



White

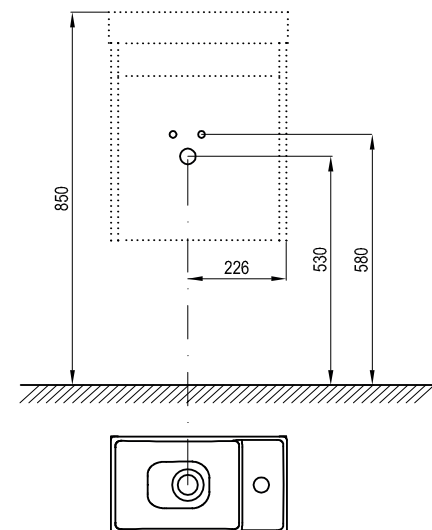
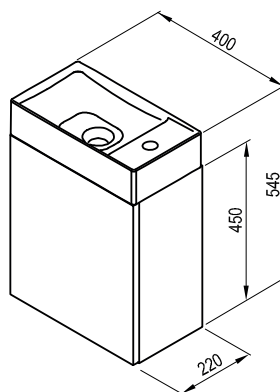

Order No.	FURNITURE	Weight (kg)	Dimensions (mm)
X000001386	SD Veda 400 white	11,7	400x220x450

Furniture dimensions specified as: width x depth x height. Product weight is listed as gross, i.e. including packaging.

Products are as standard delivered within 14 days.

Washbasins come with a 35mm hole for a standing faucet only.

# Washbasin Accessories



## Washbasin waste plugs and traps

We offer washbasin waste plugs for all applications. The low waste plug is suitable for use with furniture where it saves space and it is recommended to be combined with the waste trap U tubular. The standard waste plug looks smart if the washbasin is without furniture and can be combined with the brass waste trap. The fixed waste plug has to be used for small washbasins without an overflow, it prevents overflow of the basin.



White ceramic waste cover lends the washbasin a seamless and elegant look.



**Washbasin fixed waste plug**  
designed for washbasins without overflow.  
Available in two designs:  
chrome / white – ceramic  
Order No. X01439 / X01695

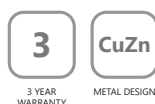

**Washbasin ClickClack waste plug**  
for all types of washbasins.  
Order No. X01373



**Washbasin ClickClack waste plug low**  
for all types of washbasins.  
Combined with the waste trap  
U tubular it is suitable for washbasins  
with furniture where it saves space.  
Order No. X01437



**Washbasin waste trap U tubular**  
Suitable particularly for L and I countertops.  
In combination with a low waste plug suitable for  
washbasins with furniture.  
Order No. X01436



**Washbasin waste trap chrome-plated**  
Telescopic waste trap suitable primarily  
for L, I countertops and separate  
washbasins.  
Order No. X01371



**Washbasin furniture waste trap**  
Suitable in combination with a low  
waste plug.  
The space in the bottom drawer  
of the furniture is not limited by the  
waste trap body. The drawer inside  
stays intact and holds larger items.  
Order No. X01612



# Sanitary Ware and Accessories

Combination of fired natural raw materials  
enriched by original design.



**10-year warranty for WC, bidets  
and installation flushing modules**



# WC Uni Chrome



CONCEPTS  
Concept Chrome



Uni Chrome toilet bowls meet the highest demands on hygiene and efficiency. Wall hanging system and compact outer shapes with no bolts, make cleaning of the bathroom much easier. Their design matches any modern interior.





### WC Uni Chrome RimOff

360 x 510 x 350 mm  
The only toilet bowl cleaning technology that actually works. No rim, so no inaccessible spots for bacteria.  
Order No. X01535



### WC Uni Chrome Rim

360 x 510 x 350 mm  
Special shape of the toilet bowl rim for easy access when cleaning.  
Order No. X01516



### WC seat Uni Chrome Slim

358 x 453 x 51 mm  
Extra thin seat made of durable plastic, equipped with the Soft Close slow-down system.  
Order No. X01550



### WC seat Uni Chrome

354 x 427 x 40 mm  
A standard seat made of durable plastic, equipped with the Soft Close slow-down system.  
Order No. X01549



### WC flush plates Chrome

247 x 165 mm  
Harmonious shape of oval characterises the Chrome design of steel buttons. The mechanism is integrated in the wall so the buttons only slightly protrude. In two options: white/satin  
Order No. X01455 / X01454



### Installation flushing module W

592 x 145 - 220 x 1062 mm  
Basic module for a wall-hung toilet with a connection spacing of 180 or 230 mm, designed for wall and lining. Also suitable for bathroom renovations. The product includes an insulation board for the toilet. Economical adjustable dual flushing in the range of 2.5-3.5 litres for small and 6-9 litres for large flushes.  
Order No. X01702



G module with a strut

### Installation flushing module G

510 x 115 - 195 x 1120 mm  
Framed module for wall-hung toilets for installation in plasterboard constructions. The product includes an insulation board. Adjustable flushing between 2-3.5 litres / 6-9 litres. Full polystyrene insulation prevents condensation on the tank surface. Preparation for connecting the holder with DG 1/2" transition for bidet seats and showers. Adding a strut to the module creates a variant suitable for anchoring during apartment cores reconstruction. Module installed in this way is self-supporting.

Order No. X01703

Strut for concealed module G

Order No. X01460

Product dimensions: width x depth x height.  
Products are as standard delivered within 14 days.  
10 year warranty for toilet bowl; 3 year warranty for toilet seats; 3 year warranty for toilet flush plates;  
10 year warranty for the built-in parts of the installation flushing modules; 3 year warranty for replaceable parts of installation flushing modules.



Chrome toilet bowls meet the highest demands on hygiene and efficiency. They do not require additional cleaning after each use, the technology of perfect rinse of the toilet bowl will do it all. Hanging system for very easy cleaning of the bathroom. Its design fits perfectly with the Chrome concept.



### WC Chrome RimOff

360 x 525 x 350 mm

The only toilet bowl cleaning technology that actually works. No rim, so no inaccessible spots for bacteria.

Order No. X01651



### WC seat Chrome

365 x 430 x 40 mm

A standard seat made of durable plastic, equipped with the Soft Close slow-down system.

Order No. X01451



### WC flush plates Chrome

247 x 165 mm

Harmonious shape of oval characterises the Chrome design of steel buttons. The mechanism is integrated in the wall so the buttons only slightly protrude. In two options: white/satin

Order No. X01455 / X01454



### Installation flushing module W

592 x 145 - 220 x 1062 mm

Basic module for a wall-hung toilet with a connection spacing of 180 or 230 mm, designed for wall and lining. Also suitable for bathroom renovations. The product includes an insulation board for the toilet. Economical adjustable dual flushing in the range of 2.5-3.5 litres for small and 6-9 litres for large flushes.

Order No. X01702



G module with a strut

### Installation flushing module G

510 x 115 - 195 x 1120 mm

Framed module for wall-hung toilets for installation in plasterboard constructions. The product includes an insulation board. Adjustable flushing between 2-3.5 litres / 6-9 litres. Full polystyrene insulation prevents condensation on the tank surface. Preparation for connecting the holder with DG 1/2" transition for bidet seats and showers. Adding a strut to the module creates a variant suitable for anchoring during apartment cores reconstruction. Module installed in this way is self-supporting.

Order No. X01703

Strut for concealed module G

Order No. X01460

Product dimensions: width x depth x height.

Products are as standard delivered within 14 days.

10 year warranty for toilet bowl; 3 year warranty for toilet seats; 3 year warranty for toilet flush plates;

10 year warranty for the built-in parts of the installation flushing modules; 3 year warranty for replaceable parts of installation flushing modules.





The Classic RimOff toilet bowl completely lacks the flushing rim, eliminating the risk of dirt deposition. Without the flushing rim inside the toilet bowl, there are no inaccessible places. The special construction of the toilet allows precise washing with only a stream of water without the need for additional cleaning. The WC Classic RimOff design is adapted to the concept of the same name which includes several bathtubs, washbasins, faucets, and bathroom furniture. You can therefore have the bathroom with toilet in one style.



### WC Classic RimOff

365 x 510 x 325 mm  
 With technology that keeps the toilet bowl really clean and in design ideally suited to the Classic concept.  
 Order No. X01671



### WC seat Classic Slim

360 x 445 mm x 51 mm  
 Extra thin seat made of durable plastic, equipped with the Soft Close slow-down system.  
 Order No. X01673



### WC seat Classic

365 x 445 mm x 40 mm  
 A standard seat made of durable plastic, equipped with the Soft Close slow-down system.  
 Order No. X01672



### WC flush plates Uni

247 x 165 mm  
 Plastic buttons with surface treatment to make them scratch resistant. Available in two designs: white/satin  
 Order No. X01457 / X01456



### WC flush plate Twin Satin

247 x 165 mm  
 The metal buttons mechanism is integrated into the wall, so that the buttons only slightly protrude above the tiling, promoting a clean, unified look.  
 Order No. X01739



### Installation flushing module W

592 x 145 - 220 x 1062 mm  
 Basic module for a wall-hung toilet with a connection spacing of 180 or 230 mm, designed for wall and lining. Also suitable for bathroom renovations. The product includes an insulation board for the toilet. Economical adjustable dual flushing in the range of 2.5-3.5 litres for small and 6-9 litres for large flushes.  
 Order No. X01702



G module with a strut

### Installation flushing module G

510 x 115 - 195 x 1120 mm  
 Framed module for wall-hung toilets for installation in plasterboard constructions. The product includes an insulation board. Adjustable flushing between 2-3.5 litres / 6-9 litres. Full polystyrene insulation prevents condensation on the tank surface. Preparation for connecting the holder with DG 1/2" transition for bidet seats and showers. Adding a strut to the module creates a variant suitable for anchoring during apartment cores reconstruction. Module installed in this way is self-supporting.

Order No. X01703

Strut for concealed module G

Order No. X01460

Product dimensions: width x depth x height.  
 Products are as standard delivered within 14 days.  
 10 year warranty for toilet bowl; 3 year warranty for toilet seats; 3 year warranty for toilet flush plates;  
 10 year warranty for the built-in parts of the installation flushing modules; 3 year warranty for replaceable parts of installation flushing modules.

# Bidet and bidet accessories



CONCEPTS  
Concept Chrome



The most efficient and healthiest way of personal hygiene. Using a bidet gives you a feeling of freshness and acts preventively to protect your health.





### Bidet Uni Chrome

360 x 510 x 290 mm  
 Concealed assembly, material integrity and elegant shape matched with the Chrome concept.  
 Order No. X01517



### Bidet Chrome

360 x 525 x 300 mm  
 Ideal solution for intimate hygiene. It will please you by its effects and aesthetic harmony with the other Chrome concept equipment. Bidets Chrome are comfortable, enjoyable and help prevent health problems.  
 Order No. X01450



### Bidet faucet CR 055.00

Essential for each bidet. Flexible aerator allows individual adjustment of water flow direction for maximum benefit.  
 Find more on p. 373.  
 Order No. X070055



### Bidet waste trap

Order No. X01560



### Installation bidet module

510 x 115 - 195 x 1120 mm  
 Designed for a wall-hung bidet with a connection spacing of 180 or 230 mm.  
 For installation of a faucet, in front of a load-bearing wall or in a plasterboard construction.  
 Order No. X01704



The installation module makes mounting of the bidet very easy.



5-year warranty on faucets

# Faucets

Elegant, Reliable and Reasonably Priced

Quality faucets form the basis of any bathroom. Choose the best materials, timeless design, solid manufacture and guarantee of long life.



# Puri

Minimalism with maximum effect



The simple shapes of Puri faucets speak clearly and create a style free of all non-essentials. Unique bathtub faucet solution.



FLEXIFLOW

Adjustable aerator - makes adjustment of the water stream much easier.



5 YEAR WARRANTY FOR WATER TAPS

Puri faucets come with a 5-year warranty.



**Washbasin faucet**

190 mm, without waste  
PU 014.00  
Order No. X070113



**Washbasin faucet**

320 mm, without waste  
PU 015.00  
Order No. X070114



The 320 mm tall Puri faucet perfectly complements countertop washbasins.



Unique control system





**Thermostatic wall-mounted shower faucet**

without set  
150 mm  
PU 033.00/150  
Order No. X070116

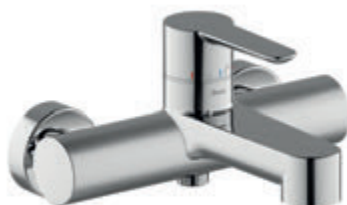

**Wall-mounted bathtub faucet**

without set  
150 mm  
PU 022.00/150  
Order No. X070115

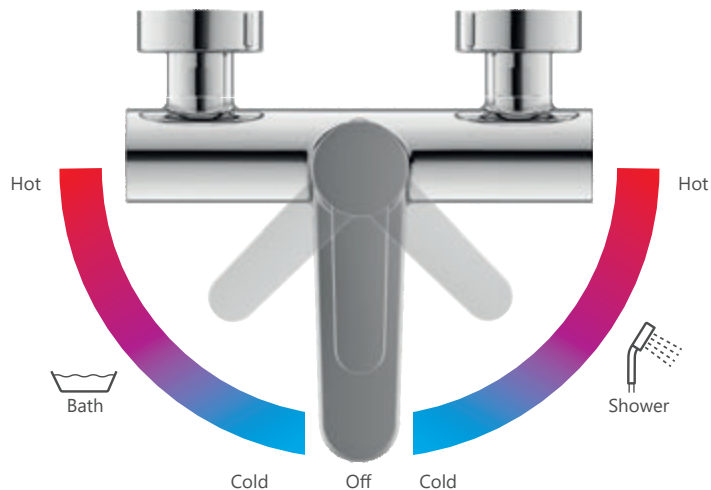

**Breakthrough solution**

PU 022 bathtub faucet with a unique control system, without a visible diverter between shower and bath.

Thanks to the rotary cartridge with bath/shower diverter, the faucet body retains a beautiful, puristically clean shape.

**Bath/shower**

Puri bathtub faucet has a special rotary cartridge with a bath/shower diverter. Moving the lever to the right (shower), or to the left (bath) only regulates water temperature, not flow rate.

# Flat

Harmony of elegant lines



The shape of Flat faucets embodies a perfect combination of flat surfaces and delicately curved contours. Their gentle flowing lines are in harmony with the water stream, making each use of Flat faucets a feast for the eye.

---

5

5 YEAR  
WARRANTY FOR  
WATER TAPS

Flat faucets come with a 5-year warranty.



SOFTMOVE

Smooth and fluid movement of the lever.



**Washbasin faucet**

without waste  
FL 014.00  
Order No. X070118



**Washbasin faucet**

with pop-up waste  
FL 013.00  
Order No. X070117



**Bidet faucet**

with pop-up waste  
FL 055.00  
Order No. X070122



**Washbasin/sink faucet**

without waste, swivel spout  
FL 016.00  
Order No. X070125







**Wall-mounted bathtub faucet**

without set  
150 mm  
FL 022.00/150  
Order No. X070119



**Wall-mounted shower faucet**

without set  
150 mm  
FL 032.00/150  
Order No. X070121



**Bathtub/shower concealed faucet**

with diverter, - for R-box Vari 072.50  
FL 065.00  
Order No. X070123



**Shower concealed faucet**

without diverter, - for R-box Vari 072.50  
FL 066.00  
Order No. X070124



**Four-hole bathtub edge faucet**

with a set  
FL 026.00  
Order No. X070120

# 10°

## Meet you halfway



10° faucets are part of the 10° concept.  
See page 19.

Original author's design! The faucet is 10° inclined towards your hand which makes its control easy and it is in harmony with every basin shape.



FLEXIFLOW

Adjustable aerator - makes adjustment of the water stream much easier.



5 YEAR  
WARRANTY FOR  
WATER TAPS

The 10° faucets are covered by a 5 year warranty.

The 10° faucets were designed  
by the Czech designer  
**Kryštof Nosál.**







**Washbasin faucet**

333 mm, without waste  
TD 015.00  
Order No. X070091



**Washbasin faucet**

170 mm, without waste  
TD 014.00  
Order No. X070062



**Washbasin faucet**

140 mm, without waste  
TD 012.00  
Order No. X070064



**Washbasin faucet**

170 mm, with pop-up waste  
TD 013.00  
Order No. X070061



**Washbasin faucet**

140 mm, with pop-up waste  
TD 011.00  
Order No. X070063



**Bidet faucet**

with pop-up waste  
TD 055.00  
Order No. X070067



reddot design award  
winner 2015



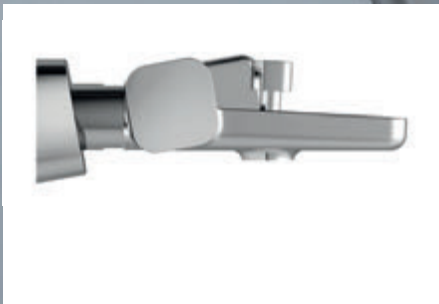

You will enjoy the dynamic interaction with the bathtubs of the 10° concept. The sophisticated asymmetry adds the 10° bathtub faucet original style allowing easy control.



**Thermostatic wall-mounted shower faucet**

without set  
150 mm  
TD 033.00/150  
Order No. X070102



**Wall-mounted bathtub faucet**

without set  
150 mm  
TD 022.00/150  
Order No. X070065



**Wall-mounted shower faucet**

without set  
150 mm  
TD 032.00/150  
Order No. X070066



**Bathtub/shower concealed faucet**

with diverter  
TD 061.00  
Order No. X070068



**Shower concealed faucet**

without diverter  
TD 062.00  
Order No. X070069



**Bathtub/shower concealed faucet**

with diverter, - for R-box  
TD 065.00  
Order No. X070070



**Shower concealed faucet**

without diverter, - for R-box  
TD 066.00  
Order No. X070071

**Shower column with thermostatic faucet and shower set**

TD 091.00/150  
Order No. X070103

Mounting of the faucet on the wall is 10° inclined toward the hand. The lever is comfortable to grasp, but it is not obstructing when showering and bathing.



Practical tilt of the washbasin faucet toward the hand and into the basin will make its use more pleasant, facilitating also cleaning of the less accessible portion between the faucet and the wall.





# 10° Free

Clean style



Customers have shown us through their interest that the idea of the 10° design appeals to them. That is why we prepared another variant of 10° faucets. The 10° line now includes both faucets with an authorial element on the lever, and a minimalistic version called 10° Free without this embossing.

Design Kryštof Nosál



FLEXIFLOW

Adjustable aerator - makes adjustment of the water stream much easier.



5 YEAR WARRANTY FOR WATER TAPS

10° Free faucets are covered by a 5-year warranty.





**Washbasin faucet**

333 mm, without waste  
TD F 015.00  
Order No. X070130



**Washbasin faucet**

170 mm, without waste  
TD F 014.00  
Order No. X070129



**Washbasin faucet**

140 mm, without waste  
TD F 012.00  
Order No. X070127



**Washbasin faucet**

170 mm, with pop-up waste  
TD F 013.00  
Order No. X070128



**Washbasin faucet**

140 mm, with pop-up waste  
TD F 011.00  
Order No. X070126



**Bidet faucet**

with pop-up waste  
TD F 055.00  
Order No. X070133





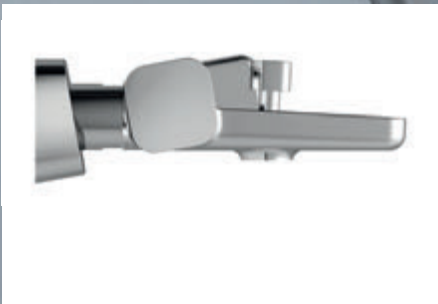

You will enjoy the dynamic interaction with the bathtubs of the 10° concept. The sophisticated asymmetry adds the 10° bathtub faucet original style allowing easy control.





**new**

**Thermostatic wall-mounted shower faucet**

without set  
150 mm  
TD F 033.00/150  
Order No. X070140

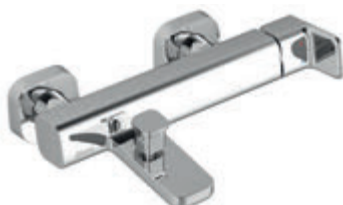

**Wall-mounted bathtub faucet**

without set  
150 mm  
TD F 022.00/150  
Order No. X070131



**Wall-mounted shower faucet**

without set  
150 mm  
TD F 032.00/150  
Order No. X070132



**new**

**Shower column with thermostatic faucet and shower set**

TD F 091.00/150  
Order No. X070141



**Bathtub/shower concealed faucet**

with diverter,  
TD F 061.00  
Order No. X070134



**Shower concealed faucet**

without diverter  
TD F 062.00  
Order No. X070135



**Bathtub/shower concealed faucet**

with diverter - for R-box  
TD F 065.00  
Order No. X070136



**Shower concealed faucet**

without diverter - for R-box  
TD F 066.00  
Order No. X070137

Mounting of the faucet on the wall is 10° inclined toward the hand. The lever is comfortable to grasp, but it is not obstructing when showering and bathing.



Practical tilt of the washbasin faucet toward the hand and into the basin will make its use more pleasant, facilitating also cleaning of the less accessible portion between the faucet and the wall.



# Bathroom Accessories 10°

10° closer to absolute comfort



10° bathroom accessories are part of the 10° concept.  
See page 19.

A set of the most necessary assistants to your pleasant stay in the bathroom.

Design Kryštof Nosál



CLEANER  
CHROME

For the cleaning of bathroom accessories, use RAVAK Cleaner Chrome or other non-aggressive cleaners in order to prevent damage to the chromium surface layer.



5 YEAR  
WARRANTY

The 10° bathroom accessories come with a 5 year warranty.



**Single hook**  
TD 110.00  
Order No. X07P353



**Double hook**  
TD 100.00  
Order No. X07P352



**Soap holder (glass)**  
TD 200.00  
Order No. X07P354



**Holder with a cup (glass)**  
TD 210.00  
Order No. X07P321



**Holder with two cups (glass)**  
TD 220.00  
Order No. X07P322



**Soap dispenser (glass)**  
TD 231.00  
Order No. X07P323



**Towel holder 25 cm**  
TD 300.00  
Order No. X07P324



**Towel holder 63 cm**  
TD 310.00  
Order No. X07P325



**Towel holder, double 63 cm**  
TD 320.00  
Order No. X07P326



**Towel rack, with a holder 63 cm**  
TD 330.00  
Order No. X07P327



**Rotary towel holder 42 cm**  
TD 340.00  
Order No. X07P328



**Toilet paper holder**  
TD 400.00  
Order No. X07P329



**Toilet brush holder and brush (glass)**  
TD 410.00  
Order No. X07P330



**Glass shelf 60 cm**  
TD 500.00  
Order No. X07P332



Products are as standard delivered within 14 days.



# Chrome

Assurance of style



Chrome faucets are part of the Chrome Concept. See page 18.

The complete range of Chrome faucets will be in natural harmony with every bathroom. Clear minimalist lines match the other parts of the Chrome bathroom concept.

Design Kryštof Nosál



FLEXIFLOW

Adjustable aerator - makes adjustment of the water stream much easier.



5 YEAR WARRANTY FOR WATER TAPS

The Chrome faucets come with a 5 year warranty.



**Washbasin faucet**  
without waste  
CR 012.00  
Order No. X070041



**Washbasin faucet**  
with pop-up waste  
CR 011.00  
Order No. X070053



**Washbasin faucet**  
311 mm, without waste  
CR 015.00  
Order No. X070100



**Sink faucet**  
CR 016.00  
Order No. X070054



**Washbasin concealed faucet**  
CR 019.00  
R-box is included  
Order No. X070093



**Washbasin faucet**  
with bidet shower, without waste  
CR 112.00  
Order No. X070092



**Bidet faucet**  
with pop-up waste  
CR 055.00  
Order No. X070055



**Freestanding bathtub faucet**  
CR 080.00  
R-box is included  
Order No. X070101



Products are as standard delivered within 14 days.



Thought-out to the  
last detail





**Wall-mounted bathtub faucet**  
with rotary spout,  
without set  
150 mm  
CR 022.00/150  
Order No. X070042



**Wall-mounted shower faucet**  
without set  
150 mm  
CR 032.00/150  
Order No. X070043



**Bathtub/shower concealed faucet**  
with diverter, - for R-box  
CR 065.00  
Order No. X070056



**Shower concealed faucet**  
without diverter, - for R-box  
CR 066.00  
Order No. X070057



**Thermostatic concealed faucet, three-way**  
for R-box Multi  
CR 067.00  
Order No. X070075



**Thermostatic concealed bath/shower faucet**  
with diverter  
CR 063.00  
Order No. X070094



**Thermostatic concealed shower faucet**  
without diverter  
CR 064.00  
Order No. X070095



**Waterfall bathtub filling faucet**  
with a set  
CR 025.00  
Order No. X070073

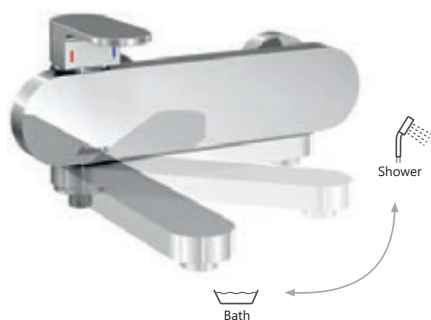

Original bath filling method – moving the lever switches over to the shower, swinging the spout starts filling the bathtub.

# Accessories Chrome

Perfectly matching accessories will underline the original design of Chrome shower enclosures.

Chrome accessories are part of the Chrome Concept. see p. 18.

Design Kryštof Nosál



CLEANER  
CHROME

For the cleaning of bathroom accessories, use RAVAK Cleaner Chrome or other non-aggressive cleaners in order to prevent damage to the chromium surface layer.



**Head shower Slim, Chrome**

square 300 mm,  
982.00  
Order No. X07P016



**Head shower Slim, Chrome**

square 200 mm,  
982.01  
Order No. X07P334



**Head shower Slim, Chrome**

round 300 mm,  
984.00  
Order No. X07P336



**Head shower Slim, Chrome**

round 200 mm,  
984.01  
Order No. X07P335



**Outlet spout, Chrome**

washbasin / bathtub  
spout length 230 mm  
CR 027.00  
Order No. X07P113



**Shower holder adjustable, Chrome**

with a joint  
611.00  
Order No. X07P011



**Hand shower, Chrome**

round - 1 mode  
957.00  
Order No. X07P007



**Bar with a sliding shower holder, Chrome**

70 cm  
974.00  
Order No. X07P013





# Bathroom Accessories Chrome

Small details make great difference



Chrome bathroom accessories are part of the Chrome Concept.  
See page 18.

A careful choice of the most popular accessories will harmonise any bathroom or WC.  
Durable and easy to clean materials will provide long-lasting satisfaction.

Design Kryštof Nosál



CLEANER  
CHROME

For the cleaning of bathroom accessories, use RAVAK Cleaner Chrome or other non-aggressive cleaners in order to prevent damage to the chromium surface layer.



5 YEAR  
WARRANTY

Chrome bathroom accessories are covered by a 5-year warranty.



RIGHT OR LEFT  
HAND  
OPTION

For products CR 200.00, 210.00 and 410.00, you will switch between the right or left hand options by turning the product over and flipping the oval cover with the logo.



**Holder with a cup (glass)**  
CR 210.00  
Order No. X07P188



**Holder with two cups (glass)**  
CR 220.00  
Order No. X07P189



**Soap holder (glass)**  
CR 200.00  
Order No. X07P187



**Soap dispenser (glass)**  
CR 231.00  
Order No. X07P223



**Oval towel holder**  
CR 300.00  
Order No. X07P190



**Single hook**  
CR 110.00  
Order No. X07P320



**Double hook**  
CR 100.00  
Order No. X07P186



**Toilet paper holder**  
CR 400.00  
Order No. X07P191



**Toilet paper holder**  
CR 420.00  
Order No. X07P318



**Toilet brush holder and brush (glass)**  
CR 410.00  
Order No. X07P196



**Rotary towel holder 42 cm**  
CR 340.00  
Order No. X07P319



**Towel holder 66 cm**  
CR 310.00  
Order No. X07P192



**Towel holder 66 cm**  
CR 320.00  
Order No. X07P193



**Towel rack, with a holder 66 cm**  
CR 330.00  
Order No. X07P194



**Glass shelf 64 cm**  
CR 500.00  
Order No. X07P195





# Classic

Slim and elegant

Classic faucets are part of the Classic concept.  
See page 23.

Graceful shapes of the Classic faucets delimited by the straight top surface perfectly complement the subtle lines of the bathtubs and washbasins. New practical details fulfil all the requirements of modern aesthetics.

---



HIDDEN  
AERATOR

Hidden aerator - allows the elegant curves to shine.



5 YEAR  
WARRANTY FOR  
WATER TAPS

The Classic faucets come with a 5 year warranty.





**Washbasin faucet**  
without waste  
CL 012.00  
Order No. X070080



**Washbasin faucet**  
with pop-up waste  
CL 011.00  
Order No. X070081



**Bidet faucet**  
with pop-up waste  
CL 055.00  
Order No. X070082



**Wall-mounted bathtub faucet**  
without set  
150 mm  
CL 022.00/150  
Order No. X070083



**Wall-mounted shower faucet**  
without set  
150 mm  
CL 032.00/150  
Order No. X070084



**Sink faucet**  
394 mm, without waste  
CL 016.00  
Order No. X070085



**Bathtub/shower concealed faucet**  
with diverter  
CL 061.00  
Order No. X070086



**Shower concealed faucet**  
without diverter  
CL 062.00  
Order No. X070087



**Bathtub/shower concealed faucet**  
with diverter, - for R-box  
CL 065.00  
Order No. X070088



**Shower concealed faucet**  
without diverter, - for R-box  
CL 066.00  
Order No. X070089

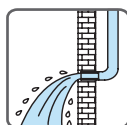

Flush the water pipes before installing the faucet. This will prevent soiling of the faucet inlet sieve, extending its life.

To clean the faucets, use the RAVAK Cleaner Chrome or other non-aggressive cleaners which will not damage the chrome surface layer. See p. 387



Concept Classic see p. 23



# Freestanding Bathtub Faucets

The tall slim silhouette of the faucet with the spout creates a symphony of beauty and utility in the bathroom. The ability to mount the faucets anywhere in the floor provides an absolute freedom when creating a custom built bathroom.



CLEANER  
CHROME

To clean the faucets, use the RAVAK Cleaner Chrome or other non-aggressive cleaners which will not damage the chrome surface layer.



EASYCLEAN

Function for simple cleaning of small shower nozzles. Limescale can be easily wiped off the nozzle surface by hand.



5 YEAR  
WARRANTY FOR  
WATER TAPS

Faucets are covered by a 5 year warranty.



**Freestanding bathtub  
faucet Chrome**

R-box is included  
CR 080.00  
Order No. X070101



**Freestanding bathtub  
faucet Freedom**

R-box is included  
FM 080.00  
Order No. X070059

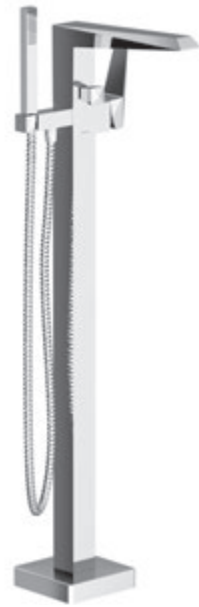

**Freestanding bathtub  
faucet Freedom**

R-box is included  
FM 081.00  
Order No. X070079

### Faucets for freestanding bathtubs and washbasins

Do not miss the new challenges provided when equipping a modern bathroom. Enjoy the freedom of using freestanding bathtubs and countertop washbasins. Original location calls for original accessories, such as faucets mounted anywhere, be it in the floor or around the washbasin.



Products are as standard delivered within 14 days.



# Bathtub Filling Faucets

Even filling a bathtub can be a joy.  
Relish the relaxing properties of water even before you submerge yourself in it.



CLEANER  
CHROME

For the cleaning of bathroom accessories, use RAVAK Cleaner Chrome or other non-aggressive cleaners in order to prevent damage to the chromium surface layer.



EASYCLEAN

Easy way of scale removal.



5 YEAR  
WARRANTY FOR  
WATER TAPS

Bathtub filling faucets come with a 5-year warranty.



**Waterfall bathtub filling faucet**  
with a set  
CR 025.00  
Order No. X070073



**Waterfall bathtub filling faucet**  
with a set  
WF 025.00  
Order No. X070060



**Waterfall bathtub filling faucet**  
with a set  
RS 025.00  
X07P003



**Four-hole bathtub edge faucet**  
with a set  
FL 026.00  
Order No. X070120

Bath filling with waterfall effect is applicable to the following bathtubs: Freedom W, Gentiana, NewDay, Rosa II, Rosa 95, LoveStory II, Asymmetric, Formy 01/ Formy 01 Slim and City/City Slim. The Rosa I bathtub can be combined with the RS 025 waterfall faucet.



# Sink / Washbasin Faucets



Reliable and fine-tuned for outfitting any kitchen



CLEANER  
CHROME

To clean the faucets, use the RAVAK Cleaner Chrome or other non-aggressive cleaners which will not damage the chrome surface layer.



EASYCLEAN

Easy way of scale removal.



SOFTMOVE

Smooth and fluid movement of the lever.





**Washbasin/sink faucet**  
CR 016.00  
Order No. X070054

**Washbasin/sink faucet**  
KM 016.00  
Order No. X070039

**Sink faucet**  
with pull-out shower  
KM 017.00  
Order No. X070078



**Washbasin/sink faucet**  
without waste, swivel spout  
FL 016.00  
Order No. X070125



**Washbasin/sink faucet**  
without waste, swivel spout  
SN 016.00  
Order No. X070038



**Washbasin/sink faucet**  
without waste, swivel spout  
CL 016.00  
Order No. X070085



**Washbasin/sink faucet**  
without waste, swivel spout  
FM 016.00  
Order No. X070090



**Washbasin/sink wall-mounted faucet**  
with a spout 250 mm  
150 mm  
SN 041.00/150  
Order No. X070008



**Washbasin/sink wall-mounted faucet**  
with a spout 250 mm  
100 mm  
SN 041.00/100  
Order No. X070007

# Termo

Constant water temperature



The thermostatic faucet will balance the changes of water pressure and temperature in the pipes, ensuring the water of the shower will always have the temperature you have set. You will never look back once you have tried the thermostatic faucet.

38°

CONSTANT  
TEMPERATURE

RAVAK thermostatic faucets keep the hot water temperature at the set level.



FAST  
REACTION

Reacts immediately to water pressure changes and keeps the mixed water at constant temperature.

5

5 YEAR  
WARRANTY  
FOR WATER  
TAPS

All thermostatic faucets feature a ceramic cartridge to control water flow and a thermostatic cartridge for water temperature control. Like the complete faucets, the cartridges are guaranteed for 5 years.



**Thermostatic wall-mounted shower faucet Termo 300**

without set  
150 mm  
TE 033.00/150  
Order No. X070096



**Thermostatic wall-mounted bathtub faucet Termo 300**

without set  
150 mm  
TE 023.00/150  
Order No. X070097



**Thermostatic wall-mounted shower faucet Termo 200**

without set  
150 mm  
TE 072.00/150  
Order No. X070051



**Thermostatic wall-mounted bathtub faucet Termo 200**

without set  
150 mm  
TE 082.00/150  
Order No. X070046



**Thermostatic wall-mounted shower faucet Termo 100**

without set  
150 mm  
TE 032.00/150  
Order No. X070034



**Thermostatic wall-mounted bathtub faucet Termo 100**

without set  
150 mm  
TE 022.00/150  
Order No. X070047

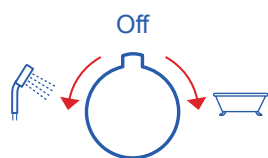

**Integrated diverter**  
The bath/shower diverter integrated in the head for simple control.



**Clear marking**  
Prevents mistaking hot for cold water.

**Safety lock**  
Against unwanted change in water temperature above 38°C.

**Scald protection**

Should there be a fault in the cold water inlet, it immediately decreases flow in the hot water inlet.

**Saving**

Reduces consumption of water and energy used for its warming.

**CoolFeel**

Faucet control on the left prevents excessive overheating of the faucet on the surface.



# Termo Dual Shower Systems



**new**

## Shower column with thermostatic faucet and shower set

TD F 091.00/150  
Order No. X070141

38°

CONSTANT TEMPERATURE

RAVAK thermostatic faucets keep the hot water temperature at the set level.



FAST REACTION

Reacts immediately to water pressure changes and keeps the mixed water at constant temperature.

5

5 YEAR WARRANTY

All thermostatic faucets feature a ceramic cartridge to control water flow and a thermostatic cartridge for water temperature control. Like the complete faucets, the cartridges are guaranteed for 5 years.

Connection of the favourite ways of showering with unique features. Simple height adjustment of the hand shower, ability to control it with one hand and indestructible metal slider of the hand shower for your long-term satisfaction.

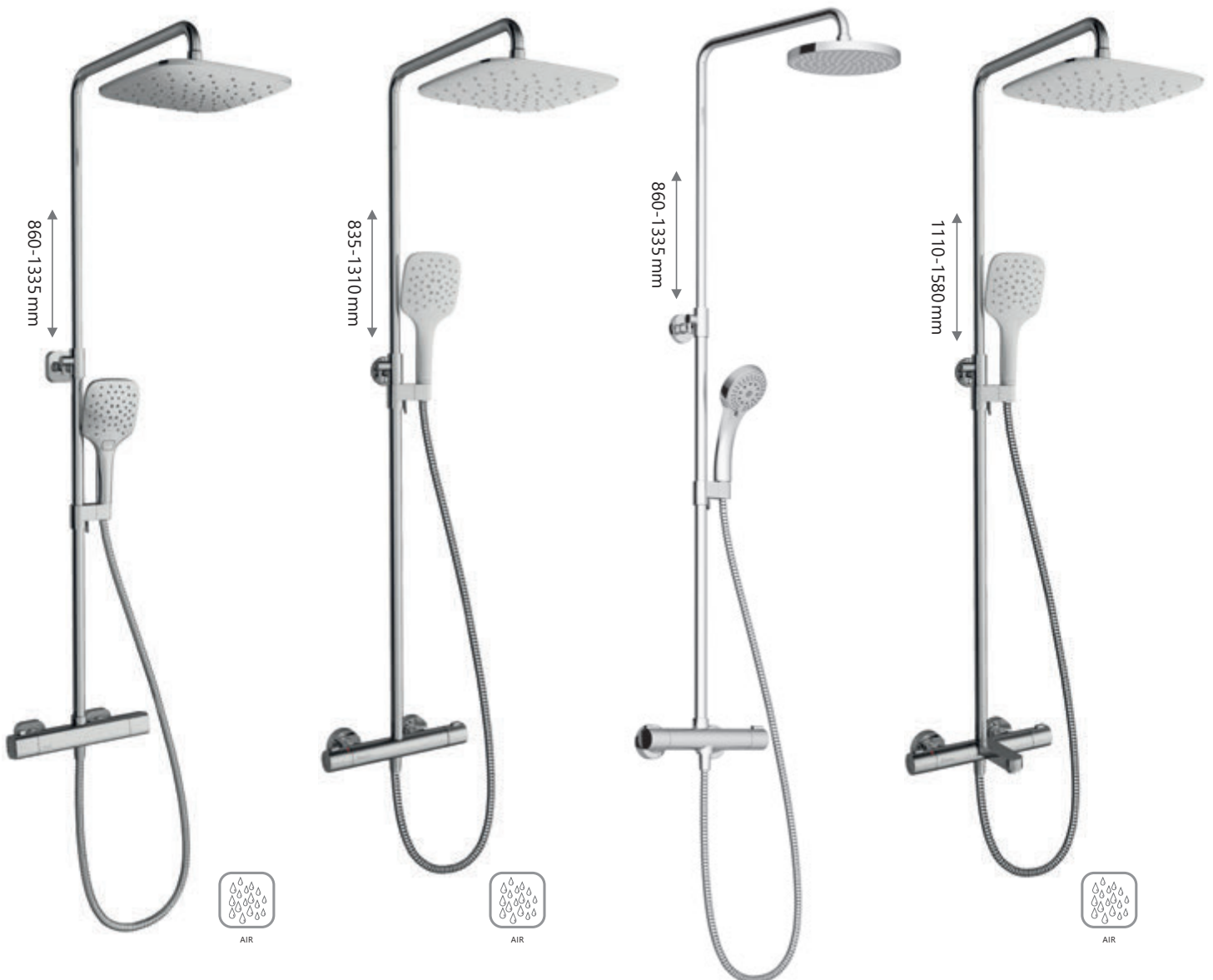

**Shower column 10°, with thermostatic faucet and shower set, chrome**  
 TD 091.00/150  
 Order No. X070103

**Shower column Termo 300, with thermostatic faucet and shower set, white**  
 TE 093.00/150  
 Order No. X070099

**Shower column Termo 100, with thermostatic faucet and shower set, chrome**  
 TE 091.00/150  
 Order No. X070058

**Bath shower column Termo 300, with thermostatic faucet and shower set, white**  
 TE 092.00/150  
 Order No. X070098

### Air feature

Allows air to be sucked into the shower. This provides a more comfortable feeling of water impact on the skin while saving water.

### Adjustment

Provides a possibility of adjusting height of the head shower as needed.

### OneHand

All brass special system for sliding the hand shower holder with one hand.

### CoolFeel

Faucet control on the left prevents excessive overheating of the faucet on the surface.

# Neo

Majestic and distinctive



Neo faucets feature robust elegance. You won't overlook a Neo faucet in your bathroom - it is attractive and will elegantly complement all of the other carefully chosen bathroom accessories.



EASYLEAN

Easy way of scale removal.



5 YEAR  
WARRANTY FOR  
WATER TAPS

Neo faucets are covered by a 5 year warranty.





**Washbasin faucet**  
without waste  
NO 012.00  
Order No. X070023



**Washbasin faucet**  
with pop-up waste  
NO 011.00  
Order No. X070016



**Bidet faucet**  
with pop-up waste  
NO 055.00  
Order No. X070019



**Wall-mounted bathtub faucet**  
without set  
150 mm  
NO 022.00/150  
Order No. X070017



**Wall-mounted shower faucet**  
without set  
150 mm  
NO 032.00/150  
Order No. X070018



**Bathtub/shower concealed faucet**  
with diverter  
NO 061.00  
Order No. X070020



**Shower concealed faucet**  
without diverter  
NO 062.00  
Order No. X070021



**Bathtub/shower concealed faucet**  
with diverter  
NO 065.00 - for R-box  
Order No. X070045



**Shower concealed faucet**  
without diverter  
NO 066.00 - for R-box  
Order No. X070044



**Concealed faucets will enhance the sleek and stylish look of your bathroom.**

**Concealed faucet with diverter directs the flow of water to two different places – either to the shower and bath, or to the hand and head shower.**

**Ergonomic diverter**

Practical shape of the diverter allows its operation with wet hand.

**Bath / shower diverter lock**

The diverter does not turn off even when the water pressure drops.

# Rosa

## Natural beauty

Rosa faucets are part of the Rosa Concept.  
See page 22.



The true beauty comes from nature. Neat and smooth lines, round edges and harmonious proportions. The Rosa faucets are designed to elegantly complement your bathroom with their beautiful and pleasing shape.



EASYCLEAN

Easy way of scale removal.



5 YEAR  
WARRANTY FOR  
WATER TAPS

Rosa faucets are covered by a 5 year warranty.



**Washbasin faucet**  
without waste  
RS 012.00  
Order No. X070022



**Washbasin faucet**  
with pop-up waste  
RS 011.00  
Order No. X070010



**Bidet faucet**  
with pop-up waste  
RS 055.00  
Order No. X070013



**Wall-mounted bathtub faucet**  
without set  
150 mm  
RS 022.00/150  
Order No. X070011



**Waterfall bathtub filling faucet**  
with a set  
RS 025.00  
Order No. X07P003



**Wall-mounted shower faucet**  
without set  
150 mm  
RS 032.00/150  
Order No. X070012



**Bathtub/shower concealed faucet**  
with diverter  
RS 061.00  
Order No. X070014



**Shower concealed faucet**  
without diverter  
RS 062.00  
Order No. X070015



**Bathtub/shower concealed faucet**  
with diverter  
RS 065.00 - for R-box  
Order No. X070050



**Shower concealed faucet**  
without diverter  
RS 066.00 - for R-box  
Order No. X070049

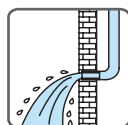

Flush the water pipes before installing the faucet. This will prevent soiling of the faucet inlet sieve, extending its life.

To clean the faucets, use the RAVAK Cleaner Chrome or other non-aggressive cleaners which will not damage the chrome surface layer. See p. 411



Rosa faucets are part of the Rosa Concept. (see p. 22)



# Suzan

Simplicity, Tradition, Reliability



Simply well working, reliable faucets. The popular classic design of Suzan faucets fits each and every bathroom. They last long and nicely complement your washbasin, bathtub or shower enclosure.

---



100/150 mm  
GAUGE

All Suzan wall-mounted faucets have a 100mm and 150mm gauge.



EASYCLEAN

Easy way of scale removal.



5-YEAR  
WARRANTY  
ON CARTRIDGES

All Suzan bathroom faucets feature a ceramic cartridge with a diameter of 35 mm which is covered by a 5 year warranty.



**Washbasin faucet**  
without waste  
SN 012.00  
Order No. X070002



**Washbasin faucet**  
with pop-up waste  
SN 011.00  
Order No. X070001



**Washbasin faucet**  
with rotary spout 150 mm  
without waste  
SN 015.00  
Order No. X070009



**Sink faucet**  
with rotary spout 230 mm  
without waste  
SN 016.00  
Order No. X070038



**Wall-mounted bathtub faucet**  
without set  
150 mm  
SN 022.00/150  
Order No. X070004



**Wall-mounted bathtub faucet**  
without set  
100 mm  
SN 022.00/100  
Order No. X070003



**Wall-mounted shower faucet**  
without set  
150 mm  
SN 032.00/150  
Order No. X070006



**Wall-mounted shower faucet**  
without set  
100 mm  
SN 032.00/100  
Order No. X070005



**Washbasin/sink wall-mounted faucet**  
with a spout 250 mm  
150 mm  
SN 041.00/150  
Order No. X070008



**Washbasin/sink wall-mounted faucet**  
with a spout 250 mm  
100 mm  
SN 041.00/100  
Order No. X070007

Who says the bathtub can be only filled with a special bathtub faucet? Use one wall-mounted faucet for both bathtub and washbasin.



Products are as standard delivered within 14 days.

# Showers and Accessories

## Long-term Pleasure and Delight

The shower's beautiful design fulfils not only the aesthetic function, but also ensures resistance of the entire mechanism, long service life, lower water consumption, simple cleaning and maintenance.



AIR

The Air feature allows air to be sucked into the shower. This provides a more comfortable feeling of water impact on the skin while saving water.



EASYCLEAN

Function for simple cleaning of small shower nozzles. Limescale can be easily wiped off the nozzle surface by hand.



EASYTWIST

EasyTwist function prevents the hose from kinking by letting the shower head rotate freely.





**Head shower Slim, Chrome**

square, 300 mm, 982.00

Order No. X07P016,

square, 200 mm, 982.01

Order No. X07P334,



**Head shower Slim, Chrome**

round, 300 mm, 984.00

Order No. X07P336,

round, 200 mm, 984.01

Order No. X07P335,



**Head shower ABS Air**

square - white

250 mm, 983.10

Order No. X07P347



**Side outlet spout**

702.00

Order No. X07P112



**Ceiling outlet spout**

703.00, 20 cm, Order No. X07P178,

704.00, 30 cm, Order No. X07P179,

705.00, 50 cm, Order No. X07P180,



**Sliding shower column**

DS 090.00

Order No. X07P232



**Hand shower, 3 modes**

120 mm

white, 958.10

Order No. X07P349,

chrome, 958.00

Order No. X07P348,



**Hand shower Air, 1 mode**

120 mm

white, 959.10

Order No. X07P351,

chrome, 959.00

Order No. X07P350,



**Hand shower Air, Chrome, 1 mode**

957.00

Order No. X07P007



**Hand shower Oval mini, 1 mode**

Consumption 6.5 litres per minute

954.00

Order No. X07P114



**Hand shower Air Flat XXL, 3 modes**

ø 140 mm, 961.00

Order No. X07P344



**Hand shower Flat S, 1 mode**

ø 100 mm, 960.00

Order No. X07P343



**Hand shower Flat Fog, 3 modes**

ø 120 mm, 956.00

Order No. X07P233



**Hand shower Flat M, 3 modes**

ø 118 mm, 953.00

Order No. X07P009



**Hand shower, 5 modes**

ø 108 mm, 952.00

Order No. X07P008

# Shower and bathtub sets



**Shower set –  
Flat M hand shower,  
3 functions, 150 cm  
hose made of durable  
plastic, 63 cm bar with  
sliding shower holder**  
902.00  
Order No. X07P177



**Bathtub set – hand  
shower, 150 cm  
single-lock stainless  
hose, small holder**  
901.00  
Order No. X07P005



**Shower set – white  
hand shower,  
3 functions, 150 cm  
hose made of durable  
plastic, 70 cm bar with  
sliding shower holder**  
921.00  
Order No. X07S002



**Bathtub set – Flat  
M hand shower,  
3 functions,  
150 cm hose made  
of durable plastic,  
small holder**  
903.00  
Order No. X07S006



**Shower set – Flat  
M hand shower,  
3 functions, 150 cm  
single-lock stainless  
hose, 60 cm bar**  
922.00  
Order No. X07S003



**Bathtub set – white  
hand shower,  
3 functions,  
150 cm hose made  
of durable plastic,  
small holder**  
Order No. X07S010

Without the hassle of combining products, when buying a shower or bathtub set, you will have all the basic products you need for showering in the bathtub or shower enclosure. You can rely on their functional and aesthetic harmony.





# Accessories



**Shower hose**  
**150 cm**  
single-lock, stainless  
steel  
911.00  
Order No. X07P006



**Shower hose**  
**150 cm**  
of durable plastic  
912.50  
Order No. X07P065



EASYTWIST



**Shower hose**  
**SatinFlex**  
of durable plastic  
150 / 200 cm  
913.00 / 913.02  
Order No. X07P176 / X07P337



EASYTWIST



**Shower hose**  
**SilverShine**  
of durable plastic  
150 / 200 cm  
914.00 / 914.02  
Order No. X07P338 / X07P339



EASYTWIST



**Shower hose**  
metal with protective layer  
150 / 200 cm  
915.00 / 915.02  
Order No. X07P340 / X07P341



EASYTWIST



**Wall-mounted**  
**water outlet**  
701.00  
Order No. X07P004



**Brass shower**  
**holder**  
**with water outlet**  
706.00  
Order No. X07P206



**Shower holder**  
**adjustable,**  
**Chrome,** with a joint  
611.00  
Order No. X07P011



**Plastic shower**  
**holder**  
612.00  
Order No. X07P345



**Plastic shower**  
**holder**  
610.00  
Order No. X07P010



**Bar with a sliding**  
**shower holder**  
**90 cm**  
973.00  
Order No. X07P014



**Bar with a sliding**  
**shower holder,**  
**Chrome 70 cm**  
974.00  
Order No. X07P013



**Bar with a sliding shower**  
**holder and wall outlet**  
**60 cm / 90 cm**  
975.00 / 975.01  
Order No. X07P342 / X07P366



**Bar with a sliding**  
**shower holder**  
**60 cm**  
972.00  
Order No. X07P012

# Faucets with a bidet shower



**Washbasin faucet Chrome**  
with bidet shower, without waste  
CR 112.00  
Order No. X070092



**Washbasin faucet with bidet shower and wall-mounted holder**  
BM 011.00  
Order No. X070076



**Wall-mounted valve with bidet shower**  
BM 040.00  
Order No. X070077



**Bidet shower**  
962.00  
Order No. X07P269

# R-box

## Basic unit for concealed faucets



### Basic unit for concealed faucets

#### R-box

RB 070.50

Order No. X070052



R-box is the perfect system for bathtub and shower concealed faucets. The body of the faucet is made of high-quality brass. Unlike with traditional concealed faucets, installing the R-box is very easy, as is replacing the top, visible portion of the unit when needed. The top, visible part of the R-box (Rosa, Neo, Classic, Chrome, 10° and 10° Free products designated 065 and 066) is mounted after the bathroom is complete, ensuring that the faucet will not get scratched or otherwise damaged during final construction work.



Suitable for bathtub and shower concealed faucets (cannot be used for thermostatic faucets).



Developed for easy and fast installation thanks to precise water levels integrated in the protection lid.



Compatible with all common piping systems (PPR, copper, plastic).

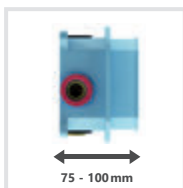

Maximum flexibility  
Ravak R-box is highly flexible in terms of depth of installation - 75 - 100 mm





**10° Free bath/shower concealed faucet**

for R-box, top part with diverter, TD F 065.00  
Order No. X070136,

without diverter, TD F 066.00  
Order No. X070137,



**10° bath/shower concealed faucet**

for R-box, top part with diverter, TD 065.00  
Order No. X070070,

without diverter, TD 066.00  
Order No. X070071,



**Chrome bath/shower concealed faucet**

for R-box, top part with diverter, CR 065.00  
Order No. X070056,

without diverter, CR 066.00  
Order No. X070057,



**Classic bath/shower concealed faucet**

for R-box, top part with diverter, CL 065.00  
Order No. X070088,

without diverter, CL 066.00  
Order No. X070089,



**Neo bath/shower concealed faucet**

for R-box, top part with diverter, NO 065.00  
Order No. X070045,

without diverter, NO 066.00  
Order No. X070044,



**Rosa bath/shower concealed faucet**

for R-box, top part with diverter, RS 065.00  
Order No. X070050,

without diverter, RS 066.00  
Order No. X070049,

**Concealed faucet without a diverter**

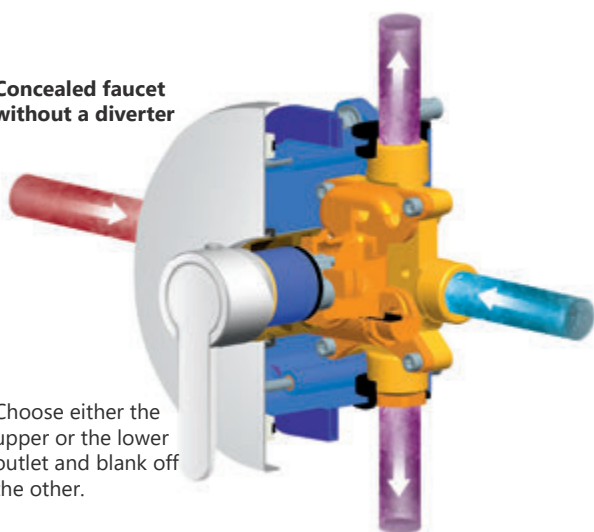

Choose either the upper or the lower outlet and blank off the other.

**Concealed faucet with a diverter**

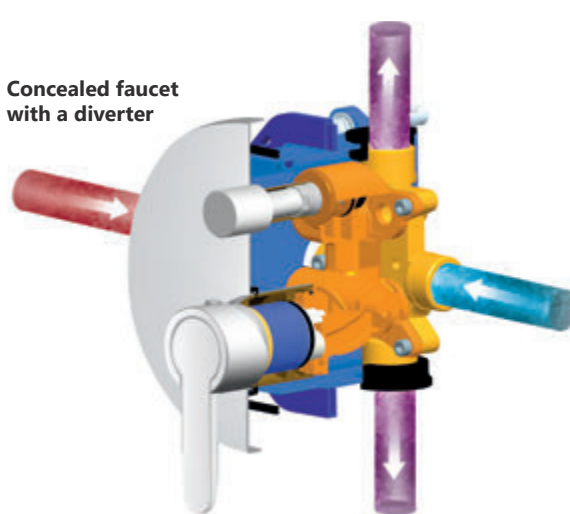

Both outlets must be connected to the piping system. When mounting the faucet to a bathtub, the outflow into the bathtub must be connected to the lower outlet and the hand shower must be connected to the upper outlet. When installing the faucet in a shower enclosure, the hand shower must be connected to the lower outlet and the head shower must be connected to the upper outlet.

# R-box Vari

Basic unit for concealed faucets



**Basic unit for  
concealed faucets**

**R-box Vari**

RB 072.50

Order No. X070139



R-box Vari is the perfect system for concealed bathtub and shower faucets. The body of the faucet itself is made of high-quality brass. Unlike with traditional concealed faucets, installing the R-box is very easy, as is replacing the top, visible portion of the unit when needed. The top, visible part of the R-box (Flat products designated 065 and 066) is mounted after the bathroom is complete, ensuring that the faucet will not get scratched or otherwise damaged during final construction work.



Suitable for bathtub and shower concealed faucets (cannot be used for thermostatic faucets).

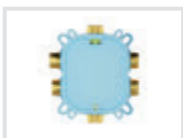

Developed for easy and fast installation thanks to precise water levels integrated in the protection lid.



Compatible with all common piping systems (PPR, copper, plastic).

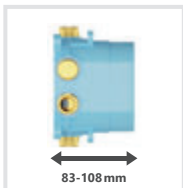

Maximum flexibility  
Ravak R-box is highly flexible in terms of depth of installation - 83-108 mm



### Bathtub/shower concealed faucet

with diverter, - for R-box Vari 072.50  
TD 065.00  
Order No. X070070



### Shower concealed faucet

without diverter, - for R-box Vari 072.50  
TD 066.00  
Order No. X070071

### Concealed faucet without a diverter

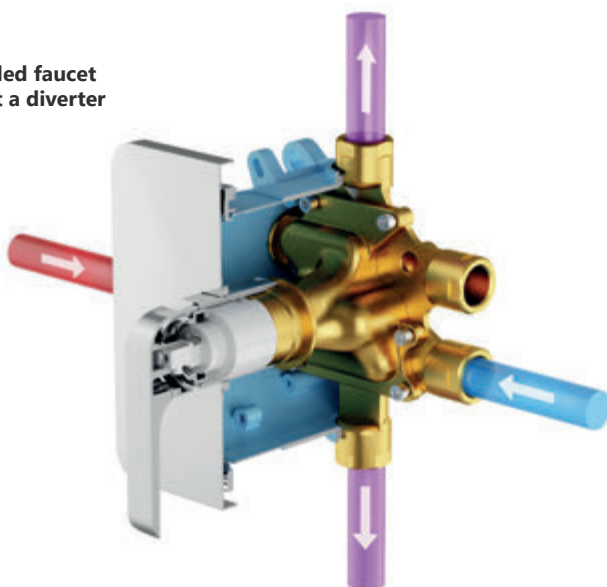

Choose either the upper or the lower outlet and blank off the other.

### Concealed faucet with a diverter

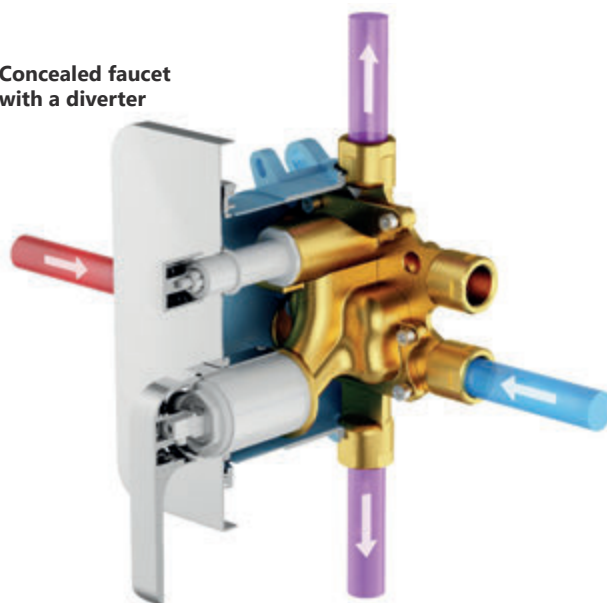

Both outlets must be connected to the piping system. When mounting the faucet to a bathtub, the outflow into the bathtub must be connected to the lower outlet and the hand shower must be connected to the upper outlet. When installing the faucet in a shower enclosure, the hand shower must be connected to the lower outlet and the head shower must be connected to the upper outlet.



# R-box Multi

Basic unit for concealed faucets



R-box Multi is a concealed multi-way mounting system for multi-way thermostatic concealed faucets (CR 067.00). The lower part of the faucet integrated into the R-box is made from high-quality brass, as is the upper part of the faucet. Installation with a base unit is easier, faster and leads to better results. The plastic box protects the interior of the faucet during concealing into the wall and allows better handling.

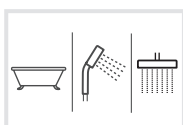

Suitable for bathtub and shower concealed faucets



Developed for easy and fast installation thanks to precise water levels integrated in the protection lid.



Compatible with all common piping systems (PPR, copper, plastic).

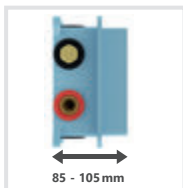

Maximum flexibility  
Ravak R-box is highly flexible in terms of depth of installation - 85 - 105 mm



**Basic unit for concealed faucets**

**R-box Multi**

RB 071.50

Order No. X070074



**Thermostatic concealed faucet, three-way**

for R-box Multi

CR 067.00

Order No. X070075

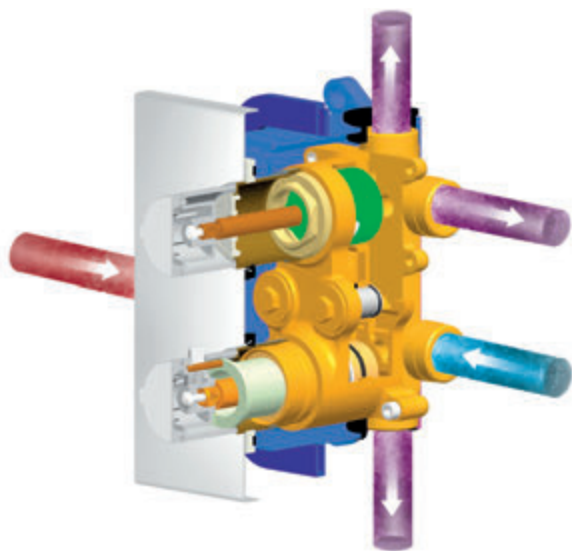

**Diversion to up to 3 places**

The CR 067.00 faucet is a wholly unique solution unlike anything on the market. It allows directing mixed water to one of three different points, meaning you can supply e.g. head shower, hand shower and the bathtub with a single faucet.

# RAVAK AntiCalc® Technology

"The best service comes directly from the manufacturer."

## An invisible shield against grime and water deposits on glass

Each type of water (except for rain- and distilled water) always contains a certain amount of dissolved mineral salts. When these salts (the so-called limescale) deposit on glass, it can be very difficult to remove them. They create a chemical bond with the glass surface, giving the glass an unsightly tint. Common cleaning products are quite ineffective against limescale.

Only the patented RAVAK AntiCalc® surface treatment technology can reliably protect glass from stable sediments. All RAVAK shower enclosure and screen glass panels are treated with RAVAK AntiCalc® during manufacture.

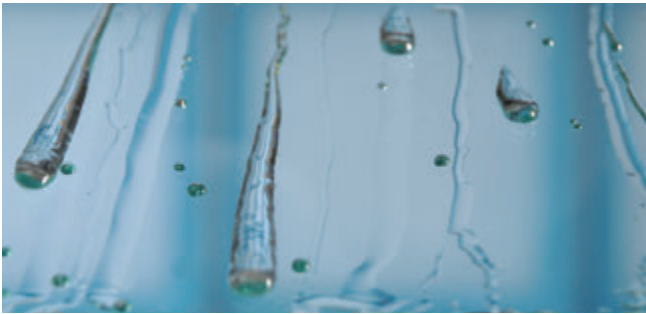

Glass sample treated with RAVAK AntiCalc® - water is repelled and runs down the glass.

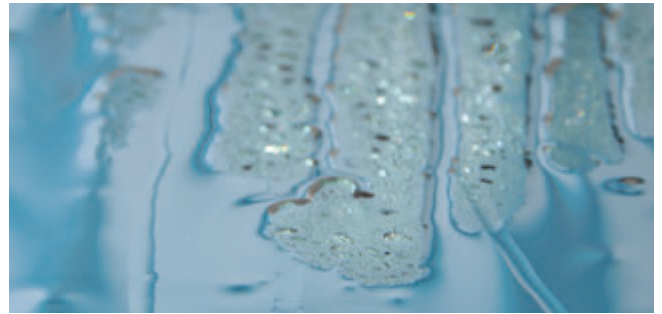

Effect of water on the glass without the use of RAVAK AntiCalc®.

## How to use RAVAK AntiCalc Conditioner?

First, clean the whole glass panel with a detergent (RAVAK Cleaner). Then apply the RAVAK Conditioner using a dry cloth on the inner side of the glass panel, which must be absolutely clean and dry. Spread the Conditioner evenly and polish the glass dry afterwards.

The water-repelling layer on the glass surface is renewed and for another 3 months (depending on the hardness of water) you just need to clean the glass panels with a common detergent.

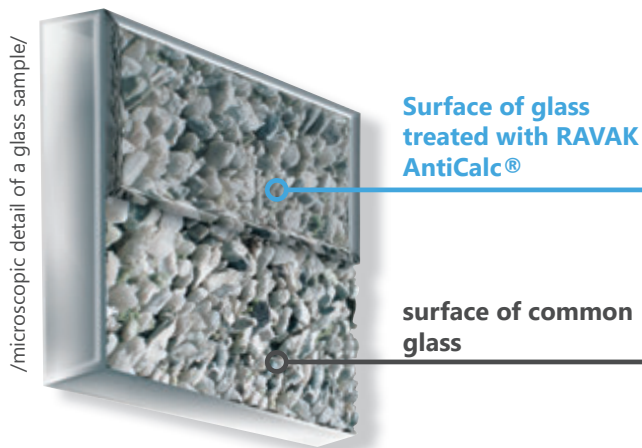



# Detergents RAVAK



## **RAVAK Cleaner** Effectively cleans the whole bathroom

- Perfectly removes grease and remaining water deposits.
  - Recommended for acrylic bathtubs, shower trays, shower enclosure panels, but also for faucets, bathroom furniture and ceramic tiles.
- Order No. X01101



## **RAVAK Cleaner Chrome** For faucets

- Special detergent intended for removing grease and scale deposits from chromium-plated surfaces of faucets, accessories for faucets and chromium-plated surfaces of shower enclosures.
- Order No. X01106



## **RAVAK AntiCalc Conditioner** Household helper in the fight against limescale

- You can renew the water-repellent qualities of our technology in your home conditions as well.
  - We guarantee 10 years of perfect functioning of RAVAK AntiCalc® system if it is regularly renewed and correctly maintained with the RAVAK AntiCalc® Conditioner.
- Order No. B3200000N



## **RAVAK Turbo Cleaner** Effectively cleans waste pipes

- Multi-effective detergent to dissolve even the heaviest grime sediments in waste pipes of bathtubs, shower trays and washbasins.
  - Do not use for cleaning of products, especially of their metal parts!
- Order No. X01105



## **Professional and durable RAVAK lubricant** Makes moving

- Intended mainly for sliders and hinges of shower enclosures, doors and screens, cartridges, movable parts of faucets, door locks and handles.
  - Water-resistant and highly effective - one droplet is enough.
- Order No. X01104



**RAVAK a. s.**  
**Obecnická 285, 261 01 Příbram 1**  
**Czech Republic**  
**phone: +420 318 427 288**  
**e-mail: [export@ravak.com](mailto:export@ravak.com)**  
**[www.ravak.com](http://www.ravak.com)**  
**<https://atypical.ravak.com>**

The manufacturer reserves the right to make technical changes to individual products, design and packaging of the product and make changes to prices. The manufacturer is not responsible for any print errors, should they occur.



**RAVAK®**